

Line Thermal Printer

StarPRNT

Command Specifications

Rev. 3.80

Star Micronics Co., Ltd.  
Special Products Division

# Table of Contents

1.	COMMAND FUNCTION LIST .....	11
2.	COMMAND DETAILS .....	19
2.1.	Explanation of Terms .....	19
2.2.	Exception Processing .....	20
2.3.	Standard Command Details .....	21
2.3.1.	Font Style and Character Set.....	21
ESC RS F n .....		21
ESC GS t n.....		22
ESC GS = n1 n2 da1 da2...dak db1 db2...dbk dc1 dc2...dck .....		24
ESC R n.....		26
ESC / n.....		27
ESC SP n .....		27
ESC & c1 c2 n d1...d48 .....		28
ESC & c1 c2 n .....		29
ESC % n.....		29
2.3.2.	Kanji characters.....	30
ESC p.....		30
ESC q.....		30
ESC \$ n .....		30
ESC s n1 n2 .....		31
ESC t n1 n2 .....		31
ESC r c1 c2 d1...dk .....		32
2.3.3.	Print Mode .....	33
ESC i n1 n2.....		33
ESC W n .....		34
ESC h n.....		34
ESC E.....		35
ESC F.....		35
ESC - n.....		36
ESC - n.....		36
ESC 4.....		37
ESC 5.....		37
SI .....		38
DC2 .....		38
2.3.4.	Horizontal Direction Printing Position .....	39
ESC I n.....		39
ESC Q n.....		39
HT .....		40

ESC D n1 n2...nk NUL .....	40
ESC D NUL.....	40
ESC GS A n1 n2.....	41
ESC GS R n1 n2.....	41
ESC GS a n .....	41
2.3.5. Line Spacing .....	42
LF.....	42
ESC a n .....	42
ESC z n .....	42
ESC 0.....	43
ESC J n.....	43
ESC I n.....	43
2.3.6. Page Control Commands .....	44
FF.....	44
ESC C n.....	44
ESC C NUL n .....	44
2.3.7. Top margin .....	45
ESC RS T n .....	45
2.3.8. Page Function .....	46
ESC GS h 0 k m n .....	46
2.3.9. Cutter Control .....	47
ESC d n .....	47
2.3.10. Reduced Printing Function Command Details.....	48
ESC GS c h v.....	48
2.3.11. Page Mode Command Details .....	49
ESC GS P 0 .....	49
ESC GS P 1 .....	50
ESC GS P 2 n .....	50
ESC GS P 3 xL xH yL yH dxL dxH dyL dyH .....	51
ESC GS P 4 nL nH.....	52
ESC GS P 5 nL nH.....	52
ESC GS P 6 .....	53
ESC GS P 7 .....	53
ESC GS P 8 .....	53
2.3.12. Bit Image Graphics .....	54
ESC K n1 n2 d1...dk.....	54
ESC L n1 n2 d1...dk .....	55
ESC k n1 n2 d1...dk .....	56
ESC X n1 n2 d1...dk.....	57
ESC GS S m xL xH yL yH n [d1 d2...dk] .....	58
ESC GS X m xL xH yL yH p1 p2 p3 p4 n [d1 d2...dk] .....	60
2.3.13. Logo .....	61
ESC GS ( L pL pH m fn [parameter] .....	61
ESC GS 8 L p1 p2 p3 p4 m fn [parameter] .....	61

<Function 48> ESC GS ( L pL pH m fn (fn=48).....	62
<Function 48> ESC GS 8 L p1 p2 p3 p4 m fn (fn=48) .....	62
<Function 51> ESC GS ( L pL pH m fn (fn=51).....	63
<Function 51> ESC GS 8 L p1 p2 p3 p4 m fn (fn=51) .....	63
<Function 64> ESC GS ( L pL pH m fn d1 d2 (fn=64) .....	64
<Function 64> ESC GS 8 L p1 p2 p3 p4 m fn d1 d2 (fn=64) .....	64
<Function 65> ESC GS ( L pL pH m fn d1 d2 d3 (fn=65) .....	65
<Function 65> ESC GS 8 L p1 p2 p3 p4 m fn d1 d2 d3 (fn=65) .....	65
<Function 66> GS ( L pL pH m fn kc1 kc2 (fn=66) .....	66
<Function 66> GS 8 L p1 p2 p3 p4 m fn kc1 kc2 (fn=66) .....	66
<Function 67> ESC GS ( L pL pH m fn a kc1 kc2 b xL xH y L yH [c d1 ... dk] 1 ... [c d1 ... dk] b (fn=67).....	67
<Function 67> ESC GS 8 L p1 p2 p3 p4 m fn a kc1 kc2 b xL xH y L yH [c d1 ... dk] 1 ... [c d1 ... dk] b (fn=67).....	67
<Function 69> ESC GS ( L pL pH m fn kc1 kc2 x y (fn=69).....	69
<Function 69> ESC GS 8 L p1 p2 p3 p4 m fn kc1 kc2 x y (fn=69) .....	69
ESC GS ) L pL pH fn [parameter].....	70
<Function 48> ESC GS ) L pL pH fn kc1 kc2.....	71
<Function 49> ESC GS ) L pL pH fn kc1 kc2.....	73
<Function 50> ESC GS ) L p L p H f n d 1 d 2.....	73
<Function 51> ESC GS ) L pL pH fn kc1 kc2.....	74
2.3.14. Bar Code .....	75
ESC b n1 n2 n3 n4 d1...dk RS.....	75
2.3.15. Two-Dimensional Bar Code QR Code Command Details .....	79
ESC GS y S 0 n.....	81
ESC GS y S 1 n.....	81
ESC GS y S 2 n.....	81
ESC GS y D 1 m nL nH d1 d2 ... dk.....	82
ESC GS y D 2 a m1 n1L n1H d11 d12 ... d1k m2 n2L n2H d21 d22 ... d2k ml ... dlk.....	83
ESC GS y P .....	84
2.3.16. Two-Dimensional Bar Code PDF417 Command Details .....	85
ESC GS x S 0 n p1 p2.....	87
ESC GS x S 1 n.....	87
ESC GS x S 2 n.....	87
ESC GS x S 3 n.....	88
ESC GS x D nL nH d1 d2 ... dk .....	88
ESC GS x P .....	88
2.3.17. GS1 2D Code, Compound symbol Command Details .....	89
ESC GS ( k pL pH cn fn [parameter] .....	89
<Function 367> ESC GS ( k pL pH cn fn n (cn=51, fn=67) .....	90
<Function 371> ESC GS ( k pL pH cn fn nL nH (cn=51, fn=71).....	90
<Function 380> ESC GS ( k pL pH cn fn m n d1...dk (cn=51, fn=80).....	91
<Function 381> ESC GS ( k pL pH cn fn m (cn=51, fn=81) .....	92
<Function 467> ESC GS ( k pL pH cn fn n (cn=52, fn=67) .....	93
<Function 471> ESC GS ( k pL pH cn fn nL nH (cn=52, fn=71).....	93
<Function 472> ESC GS ( k pL pH cn fn n (cn=52, fn=72) .....	94

<Function 480> ESC GS ( k pL pH cn fn m a b d1...dk (cn=52, fn=80) .....	95
<Function 481> ESC GS ( k pL pH cn fn m (cn=52, fn=81) .....	96
2.3.18. Initialization Command.....	97
ESC @.....	97
ESC ACK CAN.....	97
ESC ? LF NUL.....	98
2.3.19. Memory Switch Setting Command .....	99
ESC GS # m N n1 n2 n3 n4 LF NUL .....	99
2.3.20. Status .....	100
ESC RS a n .....	100
ESC ACK SOH.....	100
ETB.....	101
ESC RS E n .....	101
ESC GS ETX s n1 n2.....	102
ESC # * LF NUL .....	105
ESC GS ) I pL pH fn [parameter] .....	105
<Function 48> ESC GS ) I pL pH fn d1 d2.....	106
<Function 49> ESC GS ) I pL pH fn .....	107
<Function 50> ESC GS ) I pL pH fn .....	109
<Function 51> ESC GS ) I pL pH fn d1 d2.....	110
<Function 52> ESC GS ) I pL pH fn d1 d2.....	111
ESC GS J pL pH fn [parameter] .....	112
<Function 48> ESC GS J pL pH fn d1 d2 .....	113
<Function 49> ESC GS J pL pH fn m d1 d2 d3.....	114
2.3.21. Print Settings .....	115
ESC RS A n .....	115
ESC RS d n .....	116
ESC RS r n.....	117
2.3.22. Special Command.....	118
ESC RS R n .....	118
ESC GS m p k n.....	118
2.3.23. UTF Command .....	119
ESC GS ) U pL pH fn [parameter] .....	119
<Function 48> ESC GS ) U pL pH fn m (fn=48).....	119
<Function 64> ESC GS ) U pL pH fn m (fn=64).....	120
<Function 65> ESC GS ) U pL pH fn n1 n2 n3 n4 (fn=65).....	121
2.3.24. Black Mark Related Command Details.....	123
ESC d n .....	123
FF.....	124
ESC C n.....	124
ESC C NUL n .....	124
2.3.25. Color Printing Command Details .....	125
ESC RS c n.....	125
ESC RS C n .....	126

ESC 4.....	127
ESC 5.....	127
2.3.26. External Device Drive .....	128
ESC BEL n1 n2 .....	128
BEL.....	129
FS.....	129
SUB .....	130
EM.....	131
ESC GS EM DC1 m n1 n2.....	132
ESC GS EM DC2 m n1 n2.....	133
2.3.27. Melody Speaker Commands .....	134
ESC GS s R z n k1 k2 k3 d1...dk .....	134
2.3.28. Barcode Reader Command.....	135
ESC GS B 0 .....	135
ESC GS B 1 .....	135
ESC GS B 2 .....	136
ESC GS B 3 .....	136
2.3.29. Magnetic Card Reader Commands .....	137
ESC M C .....	137
ESC M D .....	137
ESC M E .....	137
ESC M F.....	138
ESC M G .....	138
ESC M J.....	138
EOT .....	138
2.3.30. Customer display Commands .....	139
ESC GS B @.....	139
ESC RS B A.....	139
ESC GS B B.....	140
ESC GS B C.....	140
2.3.31. Network Commands.....	141
ESC GS ) N pL pH fn [parameter] .....	141
<Function 48> ESC GS ) N pL pH fn m n (fn=48) .....	145
<Function 49> ESC GS ) N pL pH fn m d1 d2 d3 d4 (fn=49).....	145
<Function 50> ESC GS ) N pL pH fn m d1 d2 d3 d4 (fn=50).....	146
<Function 51> ESC GS ) N pL pH fn m d1 d2 d3 d4 (fn=51).....	146
<Function 52> ESC GS ) N pL pH fn m n (fn=52) .....	147
<Function 53> ESC GS ) N pL pH fn m n (fn=53) .....	147
<Function 54> ESC GS ) N pL pH fn m n (fn=54) .....	148
<Function 55> ESC GS ) N pL pH fn m n (fn=55) .....	148
<Function 57> ESC GS ) N pL pH fn m n (fn=57) .....	149
<Function 58> ESC GS ) N pL pH fn m d1 d2 d3 d4 (fn=58).....	150
<Function 59> ESC GS ) N pL pH fn m d1 d2 d3 d4 (fn=59).....	150
<Function 64> ESC GS ) N pL pH fn m (fn=64).....	151

<Function 65> ESC GS ) N pL pH fn m (fn=65).....	151
<Function 66> ESC GS ) N pL pH fn m (fn=66).....	152
<Function 67> ESC GS ) N pL pH fn m (fn=67).....	152
<Function 68> ESC GS ) N pL pH fn m (fn=68).....	153
<Function 69> ESC GS ) N pL pH fn m (fn=69).....	153
<Function 70> ESC GS ) N pL pH fn m n (fn=70).....	154
<Function 71> ESC GS ) N pL pH fn m n (fn=71).....	154
<Function 73> ESC GS ) N pL pH fn m (fn=73).....	155
<Function 74> ESC GS ) N pL pH fn m (fn=74).....	156
<Function 75> ESC GS ) N pL pH fn m (fn=75).....	157
<Function 80> ESC GS ) N pL pH fn m n (fn=80).....	158
<Function 81> ESC GS ) N pL pH fn m (fn=81).....	158
<Function 82> ESC GS ) N pL pH fn m n (fn=82).....	159
<Function 83> ESC GS ) N pL pH fn m (fn=83).....	159
<Function 84> ESC GS ) N pL pH fn m n (fn=84).....	160
<Function 85> ESC GS ) N pL pH fn m (fn=85).....	160
<Function 86> ESC GS ) N pL pH fn m n (fn=86).....	161
<Function 87> ESC GS ) N pL pH fn m (fn=87).....	161
<Function 88> ESC GS ) N pL pH fn m n (fn=88).....	162
<Function 89> ESC GS ) N pL pH fn m (fn=89).....	162
<Function 90> ESC GS ) N pL pH fn m n (fn=90).....	163
<Function 91> ESC GS ) N pL pH fn m (fn=91).....	163
<Function 92> ESC GS ) N pL pH fn m n (fn=92).....	164
<Function 93> ESC GS ) N pL pH fn m (fn=93).....	164
<Function 94> ESC GS ) N pL pH fn m n (fn=94).....	165
<Function 95> ESC GS ) N pL pH fn m (fn=95).....	165
<Function 112> ESC GS ) N pL pH fn m n (fn=112).....	166
<Function 113> ESC GS ) N pL pH fn m n (fn=113).....	167
<Function 114> ESC GS ) N pL pH fn m d1 ... dk (fn=114).....	168
<Function 115> ESC GS ) N pL pH fn m (fn=115).....	168
<Function 116> ESC GS ) N pL pH fn m n (fn=116).....	169
<Function 128> ESC GS ) N pL pH fn m d1 ... dk (fn=128).....	170
<Function 129> ESC GS ) N pL pH fn m (fn=129).....	170
<Function 130> ESC GS ) N pL pH fn m n (fn=130).....	171
<Function 131> ESC GS ) N pL pH fn m (fn=131).....	171
<Function 132> ESC GS ) N pL pH fn m d1 ... dk (fn=132).....	172
<Function 133> ESC GS ) N pL pH fn m (fn=133).....	172
<Function 134> ESC GS ) N pL pH fn m n1 n2 (fn=134).....	173
<Function 135> ESC GS ) N pL pH fn m (fn=135).....	173
<Function 136> ESC GS ) N pL pH fn m d1 ... dk (fn=136).....	174
<Function 137> ESC GS ) N pL pH fn m (fn=137).....	174
<Function 138> ESC GS ) N pL pH fn m d1 ... dk (fn=138).....	175
<Function 139> ESC GS ) N pL pH fn m (fn=139).....	175
<Function 140> ESC GS ) N pL pH fn m n d1 ... dk (fn=140).....	176

<Function 141> ESC GS ) N pL pH fn m (fn=141) .....	177
<Function 142> ESC GS ) N pL pH fn m n d1 ... dk (fn=142) .....	178
<Function 143> ESC GS ) N pL pH fn m (fn=143) .....	178
<Function 144> ESC GS ) N pL pH fn m n (fn=144) .....	179
<Function 145> ESC GS ) N pL pH fn m (fn=145) .....	179
<Function 146> ESC GS ) N pL pH fn m n (fn=146) .....	180
<Function 147> ESC GS ) N pL pH fn m (fn=147) .....	180
<Function 150> ESC GS ) N pL pH fn m d1 ... dk (fn=150) .....	181
<Function 152> ESC GS ) N pL pH fn m n1 n2 (fn=152) .....	182
<Function 153> ESC GS ) N pL pH fn m (fn=153) .....	182
2.3.32. Command related to paper hold control .....	183
ESC SYN DC3 n .....	183
ESC SYN DC4 n .....	184
ESC GS ) s pL pH fn m (fn=48) .....	184
2.3.33. Spooler .....	185
ESC GS ) SP p1 p2 p3 p4 fn [parameter] .....	185
<Function 48>ESC GS ) SP p1 p2 p3 p4 fn r t1 t2 a1 a2 ad1...adk .....	186
<Function 49>ESC GS ) SP p1 p2 p3 p4 fn id1 id2 (fn = 49) .....	187
<Function 50>ESC GS ) SP p1 p2 p3 p4 fn n1 n2 (fn = 50) .....	189
2.3.34. Star Configuration Commands .....	191
ESC GS ) # p1 p2 p3 p4 fn [parameter] .....	191
<Function 48>ESC GS ) # p1 p2 p3 p4 fn d1 d2 ... dn (fn = 48) .....	192
<Function 49>ESC GS ) # p1 p2 p3 p4 fn d1 d2 ... dn (fn = 49) .....	193
3. CHARACTER CODE TABLES .....	194
4. APPENDIX .....	195
4.1. Appendix 1: Bar Code Specification Details .....	195
4.1.1. Code 39 .....	195
4.1.2. Interleaved 2 of 5 .....	195
4.1.3. JAN/EAN/UPC .....	196
4.1.4. Code 128 .....	197
4.1.5. Code 93 .....	199
4.1.6. NW7 (CODABAR) .....	199
4.1.7. GS1-128 .....	200
4.1.8. GS1 Databar Omnidirectional .....	203
4.1.9. GS1 Databar Truncated .....	203
4.1.10. GS1 Databar Limited .....	203
4.1.11. GS1 Databar Expanded .....	203
4.2. Appendix 2: Status Specifications .....	204
4.2.1. Automatic Status .....	204
4.2.2. Printer Status Transmission Specification for Ethernet I/F .....	217
4.3. Appendix 3: Blank Code Page Configuration .....	219



4.4. Appendix 4: Maximum Number of Input Characters for Each Version of QR Code.....	221
4.5. Appendix 5: Explanation of Page Mode .....	225
4.5.1. Overview .....	225
4.5.2. Setting Values Using Each Command in Standard Mode and Page Mode .....	225
4.5.3. Print Data Expansion to the Print Region .....	225
4.5.4. Page Mode Print Maximum Region .....	227
4.6. Appendix 6: Explanation of Print Startup Control Starting Printing When Set to Page Units.....	228
4.7. Appendix 7: Specifications of Magnetic Cards .....	229
4.7.1. Card Specifications.....	229
4.7.2. Magnetic Card Data Transmission Format .....	230
4.8. Appendix 8: Specifications when a melody speaker is connected.....	231
4.9. Appendix 9: Print Area Setting .....	232
5. COMMAND LIST FOR EACH MODEL .....	233

This specification is a command specification for StarPRNT of line thermal printer.

Information contained herein applies to the following models.

< Applicable Models:>

- mPOP
- SM-L Series
  - SM-L200
  - SM-L300
- SM-S Series
  - SM-S210i (For Japanese market only)
  - SM-S220i (Other than Japanese market)
  - SM-S230i (Other than Japanese market)
- SM-L Series
  - SM-T300i
  - SM-T400i
- mC-Print3
  - MCP30, MCP31L, MCP31LB, MCP31C, MCP31CB (1st Generation)
  - MCP31CI, MCP31CBI (2nd Generation)
- mC-Print2
  - MCP20
  - MCP21
- TSP100IV Series
  - TSP100IV
  - TSP100IV SK
- mC-Label3
- BSC10II

For the command support status of each model, refer to “5. COMMAND LIST FOR EACH MODEL”.

## 1. COMMAND FUNCTION LIST

### • Font style and character set

Commands	Name
ESC RS F	Select font
ESC GS t	Specify code page
ESC GS =	Write blank code page data
ESC R	Specify international character set
ESC /	Specify/cancel slash zero
ESC SP	Set ANK right space
ESC &	Register/delete 12 x 24 dot font download characters
ESC %	Set/cancel download characters

### • Chinese characters

Commands	Name
ESC p	Set to JIS Kanji character mode
ESC q	Cancel JIS Kanji character mode
ESC \$	Set/cancel JIS Kanji character modes
ESC s	Set two bytes Kanji characters left/right spaces
ESC t	Set 1 byte Kanji characters left/right spaces
ESC r	Register Chinese download characters

- Kanji character control commands are ignored on printers not installed with Kanji character fonts (those intended for overseas).
- All Kanji character control commands are ignored if the specification for the location of use is specified as SBCS (single byte countries) by the memory switch.

### • Print modes

Commands	Name
ESC i	Set/cancel the double wide/high printing
ESC W	Set/cancel the double wide printing
ESC h	Set/cancel the double high printing
ESC E	Select emphasized printing
ESC F	Cancel emphasized printing
ESC -	Select/cancels underling mode
ESC _	Select/cancels upperline mode
ESC 4	Select white/black inverted printing
ESC 5	Cancel white/black inverted printing
SI	Select upside-down printing
DC2	Cancel upside-down printing

## ● Horizontal direction position

Commands	Name
ESC I	Set left margin
ESC Q	Set right margin
HT	Move print position to horizontal tab position
ESC D	Set/cancel horizontal tab position
ESC GS A	Move absolute position
ESC GS R	Move relative position
ESC GS a	Specify position alignment

## ● Line spacing

Commands	Name
LF	Line feed
ESC a	Feed paper n lines
ESC z	Select line feed amount
ESC 0	Specify line spacing to 3 mm
ESC J	n/4 mm line feed
ESC I	n/8 mm line feed

## ● Page control commands

Commands	Name
FF	Form feed
ESC C	Set page length to n lines
ESC C NUL	Set page length in 24 mm units

## ● Top margin

Commands	Name
ESC RS T	Set top margin

## ● Page Function

Commands	Name
ESC GS h 0	Invert 180°

## ● Cutter control

Commands	Name
ESC d	Paper cutter instruction

## ● Reduced Printing Function Command

Commands	Name
ESC GS c h v	Set reduced printing

## ● Page Mode Commands

Commands	Name
ESC GS P 0	Selects page mode
ESC GS P 1	Cancel page mode
ESC GS P 2	Select printing direction
ESC GS P 3	Set print region in page mode
ESC GS P 4	Specify character vertical direction absolute position
ESC GS P 5	Specify character vertical direction relative position
ESC GS P 6	Prints
ESC GS P 7	Cancel printing and page mode
ESC GS P 8	Cancel print data

## ● Bit image Graphics

Commands	Name
ESC K	Standard density bit image
ESC L	High density bit image
ESC k	Fine bit image
ESC X	Fine bit image
ESC GS S	Graphics Raster data printing
ESC GS X	Graphics Raster data printing (Compress data)

## ● Logos

Commands	Name
ESC GS ( L (fn=0, 48)	Register logo data
ESC GS ( L (fn=3, 51)	Send key code of the registered NV graphics
ESC GS ( L (fn=64)	Send all key code of the NV graphics
ESC GS ( L (fn=65)	Erase entire NV graphics data
ESC GS ( L (fn=66)	Erase the specified NV graphics data
ESC GS ( L (fn=67)	Set the specified NV graphics data
ESC GS ( L (fn=69)	Print the specified NV graphics data
ESC GS 8 L (fn=0, 48)	Register logo data
ESC GS 8 L (fn=3, 51)	Send key code of the registered NV graphics
ESC GS 8 L (fn=64)	Send all key code of the NV graphics
ESC GS 8 L (fn=65)	Erase entire NV graphics data
ESC GS 8 L (fn=66)	Erase the specified NV graphics data
ESC GS 8 L (fn=67)	Set the specified NV graphics data
ESC GS 8 L (fn=69)	Print the specified NV graphics data
ESC GS ) L (fn=48)	Send the registered individual logo CRC
ESC GS ) L (fn=49)	Send the registered individual NV graphics memory capacity
ESC GS ) L (fn=50)	all key code of the registered NV graphics
ESC GS ) L (fn=51)	Send the registered NV graphics data

## ● Bar code

Commands	Name
ESC b n1 ...	Print bar code

**• QR Code commands**

Commands	Name
ESC GS y S0	Set QR code model
ESC GS y S1	Set QR code mistake correction level
ESC GS y S2	Set QR code cell size
ESC GS y D1	Set QR code data
ESC GS y D2	Set QR code data (Manual)
ESC GS y P	Print QR code

**• PDF417 commands**

Commands	Name
ESC GS x S0	Set PDF417 bar code size
ESC GS x S1	Set PDF417 ECC (security level)
ESC GS x S2	Set PDF417 module X direction size
ESC GS x S3	Set PDF417 module aspect ratio
ESC GS x D	Set PDF417 bar code data
ESC GS x P	Print PDF417 bar code

**• 2D GS1 code, Compound symbol Commands**

Commands	Name
ESC GS ( k(cn=51,fn=67)	Set 2D module siz
ESC GS ( k(cn=51,fn=71)	Set The maximum width of the 2D GS1DataBar Expanded Stacked
ESC GS ( k(cn=51,fn=80)	Store data in 2D symbol saving region
ESC GS ( k(cn=51,fn=81)	Print 2D symbol data of symbol saving region
ESC GS ( k(cn=52,fn=67)	Compound symbol: Set module size
ESC GS ( k(cn=52,fn=71)	Compound symbol: Set The maximum width of the 2D GS1DataBar Expanded Stacked
ESC GS ( k(cn=52,fn=72)	Compound symbol: Set HRI Font
ESC GS ( k(cn=52,fn=80)	Compound symbol: Store data in symbol saving region
ESC GS ( k(cn=52,fn=81)	Compound symbol: Print symbol data of symbol saving region

**• Initialization Command**

Commands	Name
ESC @	Command initialization
ESC ACK CAN	Real-time printer reset
ESC ? LF NUL	Reset printer

**• Memory Switch Command**

Commands	Name
ESC GS #	Set memory switch

**• Status**

Commands	Name
ESC RS a	Set status transmission conditions
ESC ACK SOH	Real-time printer status (ASB Status)
ETB	Update ETB status
ESC RS E	Clear ETB counter, ETB status
ESC GS ETX (s=0,1,2)	Send print end counter and initialize
ESC GS ETX (s=3,4)	Print data cancel function
ESC GS ETX (s=5)	Data time out setting
ESC # *	Printer version inquiry
ESC GS ) I (fn = 48)	Transmit multibyte font kind
ESC GS ) I (fn = 49)	Transmit Printer information
ESC GS ) I (fn = 50)	Transmit Remaining battery power
ESC GS ) I (fn = 51)	Transmit installed I/F kind
ESC GS ) I (fn = 52)	Transmit external device information
ESC GS J (fn = 48)	Send log information
ESC GS J (fn = 49)	Clear log information

**• Print settings**

Commands	Name
ESC RS A	Printing area setting
ESC RS d	Set print density
ESC RS r	Set printing speed

**• Special Commands**

Commands	Name
ESC RS R	Specify the special location of use
ESC GS m	Cleaning notification / parts replacement notification control

**• UTF Commands**

Commands	Name
ESC GS ) U (fn = 48)	Selects UTF code
ESC GS ) U (fn = 64)	Setting of the Unicode ambiguous character
ESC GS ) U (fn = 65)	Set the UTF-8 CJK Unified Ideograph font

**• Black mark Commands**

Commands	Name
ESC d	Paper cut instruction
FF	Form feed
ESC C	Set page length to n lines
ESC C NUL	Set page length in 24 mm units

**• 2 color printing related commands**

Commands	Name
ESC RS c	Specify printing color in 2 color printing mode
ESC RS C	Select/cancel 2 color printing mode
ESC 4	Specify white/black inversion and printing color red
ESC 5	Cancel white/black inversion and specify printing color black

## ● External device drive

Commands	Name
ESC BEL	Set pulse width for external device drive
BEL	External device 1 drive instruction
FS	External device 1 drive instruction
SUB	External device 2 drive instruction
EM	External device 2 drive instruction
ESC GS EM DC1	External buzzer drive pulse condition settings
ESC GS EM DC2	External buzzer drive execution

## ● Melody Speaker Command

Commands	Name
ESC GS s R	Playback of received data

## ● Barcode Reader Command

Commands	Name
ESC GS B 0	Send data to a barcode reader
ESC GS B 1	Status Request
ESC GS B 2	Barcode data request
ESC GS B 3	Buffer clear

## ● Magnetic Card Reader Commands

Commands	Name
ESC M C	Read ISO track
ESC M D	Read ISO track
ESC M E	Read ISO 2 tracks
ESC M F	Read ISO 3 tracks
ESC M G	Read ISO track (Track 3)
ESC M J	Read JIS II track
EOT	Cancel MSR mode

## ● Customer Display Command

Commands	Name
ESC GS B @	Send data to a customer display
ESC RS B A	Status request
ESC GS B B	Customer display data request
ESC GS B C	Buffer clear

## ● Network command

Commands	Name
ESC GS ) N (fn = 48)	Set acquisition method for IP address
ESC GS ) N (fn = 49)	Set IP Address
ESC GS ) N (fn = 50)	Set subnet mask
ESC GS ) N (fn = 51)	Set default gateway
ESC GS ) N (fn = 52)	Set DHCP timeout
ESC GS ) N (fn = 53)	Set 9100 multi session
ESC GS ) N (fn = 54)	Set 9100 data timeout



Commands	Name
ESC GS ) N (fn = 55)	Set disconnect message
ESC GS ) N (fn = 57)	Set Steady LAN
ESC GS ) N (fn = 58)	Set DNS 1
ESC GS ) N (fn = 59)	Set DNS 2
ESC GS ) N (fn = 64)	Send acquisition method for IP address
ESC GS ) N (fn = 65)	Send IP Address
ESC GS ) N (fn = 66)	Send subnet mask
ESC GS ) N (fn = 67)	Send default gateway
ESC GS ) N (fn = 68)	Send DHCP timeout
ESC GS ) N (fn = 69)	Send 9100 multi session
ESC GS ) N (fn = 70)	Send 9100 data timeout
ESC GS ) N (fn = 71)	Set disconnect message
ESC GS ) N (fn = 73)	Send Steady LAN
ESC GS ) N (fn = 74)	Send DNS 1
ESC GS ) N (fn = 75)	Send DNS 2
ESC GS ) N (fn = 80)	Set TCP#9100
ESC GS ) N (fn = 81)	Send TCP#9100
ESC GS ) N (fn = 82)	Set TCP#9101
ESC GS ) N (fn = 83)	Send TCP#9101
ESC GS ) N (fn = 84)	Set LPR
ESC GS ) N (fn = 85)	Send LPR
ESC GS ) N (fn = 86)	Set UDP#22222
ESC GS ) N (fn = 87)	Send UDP#22222
ESC GS ) N (fn = 88)	Set Telnet
ESC GS ) N (fn = 89)	Send Telnet
ESC GS ) N (fn = 90)	Set TCP#80
ESC GS ) N (fn = 91)	Send TCP#80
ESC GS ) N (fn = 92)	Set TCP#443
ESC GS ) N (fn = 93)	Send TCP#443
ESC GS ) N (fn = 94)	Set TCP#22222
ESC GS ) N (fn = 95)	Send TCP#22222
ESC GS ) N (fn = 112)	Save network parameters
ESC GS ) N (fn = 113)	Initialize network parameters
ESC GS ) N (fn = 114)	Execute Login
ESC GS ) N (fn = 115)	Send Login Status
ESC GS ) N (fn = 116)	Execute Logout
ESC GS ) N (fn = 128)	Set Login Password
ESC GS ) N (fn = 129)	Send Login Password Change Status
ESC GS ) N (fn = 130)	Set Star CloudPRNT Cloud Service
ESC GS ) N (fn = 131)	Send Star CloudPRNT Cloud Service
ESC GS ) N (fn = 132)	Set Star CloudPRNT Service URL
ESC GS ) N (fn = 133)	Send Star CloudPRNT Service URL
ESC GS ) N (fn = 134)	Set Star CloudPRNT Polling time
ESC GS ) N (fn = 135)	Send Star CloudPRNT Polling time
ESC GS ) N (fn = 136)	Set Star CloudPRNT User Name
ESC GS ) N (fn = 137)	Send Star CloudPRNT User Name
ESC GS ) N (fn = 138)	Set Star CloudPRNT Password

Commands	Name
ESC GS ) N (fn = 139)	Send Star CloudPRNT Password
ESC GS ) N (fn = 140)	Set Star CloudPRNT TLS trust level
ESC GS ) N (fn = 141)	Send Star CloudPRNT TLS trust level
ESC GS ) N (fn = 142)	Set Star CloudPRNT NTP Server
ESC GS ) N (fn = 143)	Send Star CloudPRNT NTP Server
ESC GS ) N (fn = 144)	Set Star CloudPRNT Cipher Suites Encryption Level
ESC GS ) N (fn = 145)	Send Star CloudPRNT Cipher Suites Encryption Level
ESC GS ) N (fn = 146)	Set Star CloudPRNT TLS1.3
ESC GS ) N (fn = 147)	Send Star CloudPRNT TLS1.3
ESC GS ) N (fn = 150)	Decrypt and send strings
ESC GS ) N (fn = 152)	Set Star CloudPRNT HTTP Response Timeout
ESC GS ) N (fn = 153)	Send Star CloudPRNT HTTP Response Timeout

- Command related to paper hold control

Commands	Name
ESC SYN DC3	Paper hold control settings
ESC SYN DC4	Paper hold status control settings
ESC GS ) s (fn = 48)	Send paper hold sensor installation data

- Spooler

Commands	Name
ESC GS ) SP (fn = 48)	Store print data in spooler
ESC GS ) SP (fn = 49)	Acquire job information with specified job ID
ESC GS ) SP (fn = 50)	Job information list (specified number of jobs)

- Star Configuration

Commands	Name
ESC GS ) # (fn = 48)	Register Star Configuration Json file
ESC GS ) # (fn = 49)	Read Star Configuration Json file

## 2. COMMAND DETAILS

### 2.1. Explanation of Terms

- Reception buffer  
The buffer for storing data (reception data) received from the host, as it is called the reception buffer. Reception data is temporarily stored in the reception buffer, then processed sequentially.
- Line buffer  
The buffer for storing image data for printing is called the line buffer.
- Line buffer full  
The state in which the buffer has no more space available is called line buffer full. When the buffer is full in standard mode, data in the line buffer is printed and a line feed is performed when new print data is processed. This is the same as a Line Feed. When the line buffer is full in the page mode, the printer move the print position to the head of the next line then starts with the new print data.
- Top of line  
The top of line is a state that satisfies the following conditions.
  - There is currently no print data in the line buffer.
  - The position is not specified with the horizontal direction position command.
- Printable region  
This is the maximum printable area with the printer's specifications.
- Print region  
This is the printing area specified by a command. (Print region ≤ printable region)
- ANK character base line
  - For SM-S and T series, the base line is the upper end of each data.
  - For the expansion position of the print data in page mode, refer to "Appendix 6 Explanation of Page Mode".

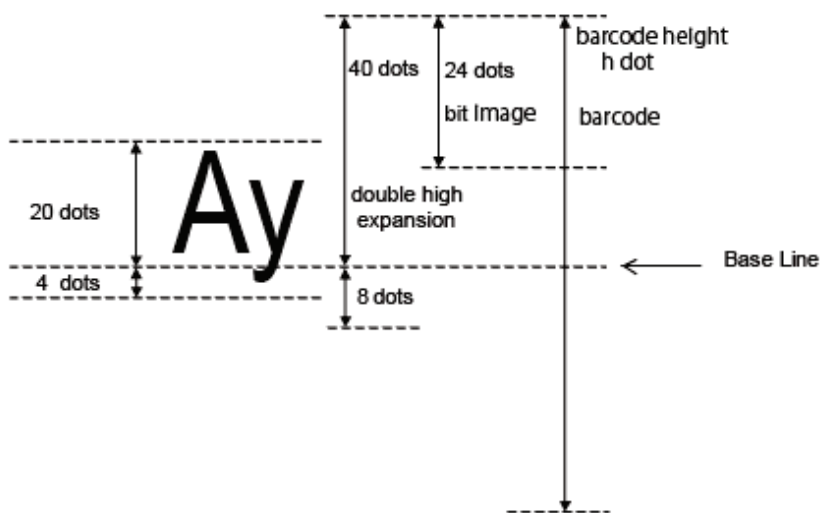

- ASB Function  
Sends the automatic status to the host each time the printer's status changed.
- NSB Function  
When the printer uses a parallel I/F or USB I/F, sends the automatic status each time the reverse transfer mode is entered. When the printer uses Ethernet I/F or wireless I/F, sends the automatic status when the printer is connected to the print port (TCP#9100). The ASB and NSB status formats are the same.

## 2.2. Exception Processing

### 1) Undefined codes

Codes from <00>H to <1F>H are targeted. When codes not defined as commands in this region are received, they are discarded.

(Ex.) If processing the data string of <30>H<31>H<03>H<32>H<0A>H<33>H, the printer will discard <03>H as an undefined code.

### 2) Undefined commands

When the data following the ESC code is a code that is not defined as a command, ESC and subsequent codes are discarded.

(Ex.) If processing the data string of <30>H<1B>H<22>H<31>H<32>H, the printer will read and discard <1B>H<22>H as an undefined command.

When the data following ESC is FS, and the data following that is not defined as a command, ESC FS and the code which follows (total 3 bytes) are discarded.

When the data following ESC is GS, and the data which follows it is a code that is not defined as a command, ESC GS and the code which follows it (total 3 bytes) is read and discarded.

When the data following ESC is RS, and the data which follows it is a code that is not defined as a command, ESC RS and the 2-byte code which follows it (total 4 bytes) is read and discarded.

### 3) Settings outside of the defined area

Processing values outside of the defined area in commands accompanying arguments, those commands are ignored and the preset values are unchanged.

(Ex.) If processing the data string of <1B>H<52>H<15>H, the printer will discard the data string of <1B>H<52>H<15>H because although <1B>H<52>H is defined as a commands (ESC R), the argument <15>H is outside of the definition. Therefore, the international character set that is already set experiences no change.

## 2.3. Standard Command Details

### 2.3.1. Font Style and Character Set

#### **ESC RS F n**

[Name] Select font  
 [Code] ASCII    ESC   RS   F   n  
           Hex.    1B   1E   46   n  
           Decimal 27   30   70   n

[Defined Region] Spec. 1  $0 \leq n \leq 1$   
                   Spec. 2  $0 \leq n \leq 2$

[Initial Value]    n = 0  
 [Function]        Selects a font

n	Font
0	Font-A (12 x 24 dots)
1	Font-B (9 x 24 dots)
2	Font-C (9 x 17 dots)

## ESC GS t n

[Name] Select code page  
 [Code] ASCII ESC GS t n  
 Hex. 1B 1D 74 n  
 Decimal 27 29 116 n

[Defined Region] Spec. 1  
 For SBCS  
 $0 \leq n \leq 21, 32 \leq n \leq 34, 64 \leq n \leq 79, 96 \leq n \leq 98, n=102, 255$

Spec. 2  
 For SBCS  
 $0 \leq n \leq 21, 32 \leq n \leq 34, 64 \leq n \leq 79, 96 \leq n \leq 98, n=102, n=255$

Spec. 3  
 For SBCS  
 $0 \leq n \leq 15, 19 \leq n \leq 32, n=255$

[Initial Value] Memory switch / Star Configuration setting

[Function] Specifies code page

n	Code Page
0	Normal*
1	CodePage437 (USA,Std. Europe)
2	Katakana
3	CodePage437 (USA,Std. Europe)
4	Codepage 858 (Multilingual)
5	Codepage 852 (Latin-2)
6	Codepage 860 (Portuguese)
7	Codepage 861 (Icelandic)
8	Codepage 863 (Canadian French)
9	Codepage 865 (Nordic)
10	Codepage 866 (Cyrillic Russian)
11	Codepage 855 (Cyrillic Bulgarian)
12	Codepage 857 (Turkey)
13	Codepage 862 (Israel (Hebrew) )
14	Codepage 864 (Arabic)
15	Codepage 737 (Greek)
16	Codepage 851 (Greek)
17	Codepage 869 (Greek)
18	Codepage 928 (Greek)
19	Codepage 772 (Lithuanian)
20	Codepage 774 (Lithuanian)
21	Codepage 874 (Thai)
32	Codepage 1252 (Windows Latin-1)
33	Codepage 1250 (Windows Latin-2)
34	Codepage 1251 (Windows Cyrillic)

n	Code Page
64	Codepage 3840 (IBM-Russian)
65	Codepage 3841 (Gost)
66	Codepage 3843 (Polish)
67	Codepage 3844 (CS2)
68	Codepage 3845 (Hungarian)
69	Codepage 3846 (Turkish)
70	Codepage 3847 (Brazil-ABNT)
71	Codepage 3848 (Brazil-ABICOMP)
72	Codepage 1001 (Arabic)
73	Codepage 2001 (Lithuanian-KBL)
74	Codepage 3001 (Estonian-1)
75	Codepage 3002 (Estonian-2)
76	Codepage 3011 (Latvian-1)
77	Codepage 3012 (Latvian-2)
78	Codepage 3021 (Bulgarian)
79	Codepage 3041 (Maltese)
96	Thai Character Code 42 (Thai)
97	Thai Character Code 11 (Thai)
98	Thai Character Code 13 (Thai)
102	Thai Character Code 18 (Thai)
255	User Setting (Blank Code Page)

When UTF-8 code is valid with SBCS setting, the UTF-8 becomes invalid by this command.

## **ESC GS = n1 n2 da1 da2...dak db1 db2...dbk dc1 dc2...dck**

[Name] Write blank code page data

[Code]	ASCII	ESC	GS	=	n1	n2	da1	da2	...	dak	db1	db2	...	Dbk	dc1	dc2	...	dck
	Hex.	1B	1D	3D	n1	n2	da1	da2	...	dak	db1	db2	...	Dbk	dc1	dc2	...	dck
	Decimal	27	29	61	n1	n2	da1	da2	...	dak	db1	db2	...	Dbk	dc1	dc2	...	dck

[Defined Area]

Spec. 1  
 n1 = 0  
 n2 = 48  
 $1 \leq (n1 + n2 \times 256)$   
 $0 \leq da \leq 255$  (Font-A data)  
 $0 \leq db \leq 255$  (Font-B data)  
 ak = 6144  
 bk = 6144  
 ck = 0 (Do not send Font-C data)

Spec. 2  
 n1 = 0  
 n2 = 48  
 $1 \leq (n1 + n2 \times 256)$   
 $0 \leq da \leq 255$  (Font-A data)  
 $0 \leq db \leq 255$  (Font-B data)  
 $0 \leq dc \leq 255$  (Font-C data)  
 ak = 6144  
 bk = 6144  
 ck = 4352

[Initial Value] ---

[Function]

Writes data into a blank code page.

A blank code page indicates a character code table where character codes from 80h to FFh are all

blank.

A blank code page can be selected using the ESC GS t n command n = 255.

The following is the data written to the blank code page.

Font-A: 1 character = 48 bytes 6144 bytes = 48 bytes x 128 characters

Font-B: 1 character = 48 bytes 6144 bytes = 48 bytes x 128 characters

Font-C: 1 character = 34 bytes 4352 bytes = 34 bytes x 128 characters

Send Font-A, Font-B and Font-C data continuously.

For models that do not support Font-C, only send Font-A / Font-B data.

The printer is reset when writing with this command is completed.





## ESC R n

[Name] Specify international character set  
 [Code] ASCII ESC R n  
 Hex. 1B 52 n  
 Decimal 27 82 n

[Defined Area] Spec.1  
 $0 \leq n \leq 14$ , n = 64  
 $48 \leq n \leq 57$  ("0"  $\leq$  n  $\leq$  "9"),  $65 \leq n \leq 69$  ("A"  $\leq$  n  $\leq$  "E")  
 Spec.2  
 $0 \leq n \leq 14$ , n = 18, n = 64  
 $48 \leq n \leq 57$  ("0"  $\leq$  n  $\leq$  "9"),  $65 \leq n \leq 69$  ("A"  $\leq$  n  $\leq$  "E")

[Initial Value] Memory switch / Star Configuration setting  
 When installed with Japanese language characters and MBCS setting: Fixed at n=8  
 When installed with Hangeul language characters and MBCS setting: Fixed at n=13

[Function] Specifies international characters  
 When installed with Japanese language characters and MBCS setting, this command is ignored.  
 When installed with Hangeul language characters and MBCS setting, this command is ignored.

n	International Characters
0, 48	USA
1, 49	France
2, 50	Germany
3, 51	UK
4, 52	Denmark
5, 53	Sweden
6, 54	Italy
7, 55	Spain
8, 56	Japan
9, 57	Norway
10, 65	Denmark II
11, 66	Spain II
12, 67	Latin America
13, 68	Korea
14, 69	Ireland
18	India
64	Legal

## ESC / n

[Name] Specify/cancel slash zero  
 [Code] ASCII ESC / n  
 Hex. 1B 2F n  
 Decimal 27 47 n

[Defined Area] n = 0, 1, 48, 49  
 [Initial Value] Memory switch / Star Configuration setting  
 [Function] Specifies and cancels slash zeros.

n	International Characters
0, 48	Cancels slash zero
1, 49	Specifies slash zero

## ESC SP n

[Name] Set ANK right space  
 [Code] ASCII ESC SP n  
 Hex. 1B 20 n  
 Decimal 27 32 n

[Defined Area]  $0 \leq n \leq 15$   
 $48 \leq n \leq 57$  ("0"  $\leq n \leq$  "9")  
 $65 \leq n \leq 70$  ("A"  $\leq n \leq$  "F")  
 [Initial Value] Memory switch / Star Configuration setting  
 [Function] Specify the right space amount of ANK characters in n dots.  
 The ANK character width is "left space amount" + "ANK font dot count" + right space amount."  
 (See the information on character specifications in the appropriate product specifications manual for details on the ANK font dot count.)

Standard mode and page mode can be set independently of each other.

## ESC & c1 c2 n d1...d48

[Name]	Register ANK download characters								
[Code]	ASCII	ESC	&	c1	c2	n	d1	...	d48
	Hex.	1B	26	c1	c2	n	d1	...	d48
	Decimal	27	38	c1	c2	n	d1	...	d48

[Defined Area] c1 = 1, 49  
 c2 = 1, 49  
 $32 \leq n \leq 127$   
 $0 \leq d \leq 255$

[Initial Value] - - -

[Function] Registers the download characters of the currently selected font (Font-A or Font-B) to the nth address. Download characters can be registered to <20>H to <7F>H. If one has been already registered to an address, it is overwritten. When parameters c1 and c2 and n are outside of the defined area, subsequent data is handled as normal data.

FONT-A data format 24 dots vertically x 12 dots horizontally

MSB						LSB						MSB						LSB					
Da1	●	●	●	●	●	●	●	●	●	●	●	Da2	●	●	●	●	○	○	○	○	○	○	
Da3	●	●	●	●	●	●	●	●	●	●	●	Da4	●	●	●	●	○	○	○	○	○	○	
Da5	●	●	●	●	●	●	●	●	●	●	●	Da6	●	●	●	●	○	○	○	○	○	○	
Da7	●	●	●	●	●	●	●	●	●	●	●	Da8	●	●	●	●	○	○	○	○	○	○	
Da9	●	●	●	●	●	●	●	●	●	●	●	Da10	●	●	●	●	○	○	○	○	○	○	
Da11	●	●	●	●	●	●	●	●	●	●	●	Da12	●	●	●	●	○	○	○	○	○	○	
Da13	●	●	●	●	●	●	●	●	●	●	●	Da14	●	●	●	●	○	○	○	○	○	○	
Da15	●	●	●	●	●	●	●	●	●	●	●	Da16	●	●	●	●	○	○	○	○	○	○	
Da17	●	●	●	●	●	●	●	●	●	●	●	Da18	●	●	●	●	○	○	○	○	○	○	
Da19	●	●	●	●	●	●	●	●	●	●	●	Da20	●	●	●	●	○	○	○	○	○	○	
Da21	●	●	●	●	●	●	●	●	●	●	●	Da22	●	●	●	●	○	○	○	○	○	○	
Da23	●	●	●	●	●	●	●	●	●	●	●	Da24	●	●	●	●	○	○	○	○	○	○	
Da25	●	●	●	●	●	●	●	●	●	●	●	Da26	●	●	●	●	○	○	○	○	○	○	
Da27	●	●	●	●	●	●	●	●	●	●	●	Da28	●	●	●	●	○	○	○	○	○	○	
Da29	●	●	●	●	●	●	●	●	●	●	●	Da30	●	●	●	●	○	○	○	○	○	○	
Da31	●	●	●	●	●	●	●	●	●	●	●	Da32	●	●	●	●	○	○	○	○	○	○	
Da33	●	●	●	●	●	●	●	●	●	●	●	Da34	●	●	●	●	○	○	○	○	○	○	
Da35	●	●	●	●	●	●	●	●	●	●	●	Da36	●	●	●	●	○	○	○	○	○	○	
Da37	●	●	●	●	●	●	●	●	●	●	●	Da38	●	●	●	●	○	○	○	○	○	○	
Da39	●	●	●	●	●	●	●	●	●	●	●	Da40	●	●	●	●	○	○	○	○	○	○	
Da41	●	●	●	●	●	●	●	●	●	●	●	Da42	●	●	●	●	○	○	○	○	○	○	
Da43	●	●	●	●	●	●	●	●	●	●	●	Da44	●	●	●	●	○	○	○	○	○	○	
Da45	●	●	●	●	●	●	●	●	●	●	●	Da46	●	●	●	●	○	○	○	○	○	○	
Da47	●	●	●	●	●	●	●	●	●	●	●	Da48	●	●	●	●	○	○	○	○	○	○	

● = Data region / ○ = Zero data

FONT-B data format 24 dots vertically x 9 dots horizontally

MSB				LSB				MSB				LSB			
Da1	●	●	●	●	●	●	●	Da2	●	○	○	○	○	○	○
Da3	●	●	●	●	●	●	●	Da4	●	○	○	○	○	○	○
Da5	●	●	●	●	●	●	●	Da6	●	○	○	○	○	○	○
Da7	●	●	●	●	●	●	●	Da8	●	○	○	○	○	○	○
Da9	●	●	●	●	●	●	●	Da10	●	○	○	○	○	○	○
Da11	●	●	●	●	●	●	●	Da12	●	○	○	○	○	○	○
Da13	●	●	●	●	●	●	●	Da14	●	○	○	○	○	○	○
Da15	●	●	●	●	●	●	●	Da16	●	○	○	○	○	○	○
Da17	●	●	●	●	●	●	●	Da18	●	○	○	○	○	○	○
Da19	●	●	●	●	●	●	●	Da20	●	○	○	○	○	○	○
Da21	●	●	●	●	●	●	●	Da22	●	○	○	○	○	○	○
Da23	●	●	●	●	●	●	●	Da24	●	○	○	○	○	○	○
Da25	●	●	●	●	●	●	●	Da26	●	○	○	○	○	○	○
Da27	●	●	●	●	●	●	●	Da28	●	○	○	○	○	○	○
Da29	●	●	●	●	●	●	●	Da30	●	○	○	○	○	○	○
Da31	●	●	●	●	●	●	●	Da32	●	○	○	○	○	○	○
Da33	●	●	●	●	●	●	●	Da34	●	○	○	○	○	○	○
Da35	●	●	●	●	●	●	●	Da36	●	○	○	○	○	○	○
Da37	●	●	●	●	●	●	●	Da38	●	○	○	○	○	○	○
Da39	●	●	●	●	●	●	●	Da40	●	○	○	○	○	○	○
Da41	●	●	●	●	●	●	●	Da42	●	○	○	○	○	○	○
Da43	●	●	●	●	●	●	●	Da44	●	○	○	○	○	○	○
Da45	●	●	●	●	●	●	●	Da46	●	○	○	○	○	○	○
Da47	●	●	●	●	●	●	●	Da48	●	○	○	○	○	○	○

● = Data region / ○ = Zero data

### ESC & c1 c2 n

[Name] Delete ANK download characters  
 [Code] ASCII ESC & c1 c2 n  
 Hex. 1B 26 c1 c2 n  
 Decimal 27 38 c1 c2 n

[Defined Area] c1 = 1, 49  
 c2 = 0, 48  
 32 ≤ n ≤ 127

[Initial Value] - - -

[Function] Deletes the download characters of the currently selected font (Font-A or Font-B) that are registered in the nth address.

### ESC % n

[Name] Specifies/cancels ANK download characters  
 [Code] ASCII ESC % n  
 Hex. 1B 25 n  
 Decimal 27 37 n

[Defined Area] n=0, 1, 48, 49

[Initial Value] ANK download characters cancelled

[Function] Specifies/cancels ANK download characters

n	Download characters
0, 48	Cancels ANK download characters
1, 49	Specifies ANK download characters

<Print example of ANK download characters>

1. ANK download character register (ESC & c1 c2 n d1...d48)
2. Specify ANK download characters (ESC % n (n = 1))
3. Prints ANK download characters

### 2.3.2. Kanji characters

#### ESC p

[Name] Specify JIS Kanji character mode  
 [Code] ASCII      ESC    p  
           Hex.      1B   70  
           Decimal   27  112

[Defined Area]    - - -

[Initial Value]   JIS Kanji character mode cancelled

[Function]        Specifies JIS Kanji character mode

When in JIS Kanji character mode, character codes are all handled as 2-byte Kanji characters (First byte: upper code; second byte: lower code).

This command is ignored for models not equipped with Japanese and Kanji characters and when the specification for the location of use is specified as SBCS (single byte countries) by the memory switch / Star Configuration.

This command is ignored when UTF-8 is specified (command: ESC GS t 128) for MBCS.

#### ESC q

[Name] Cancel JIS Kanji character mode  
 [Code] ASCII      ESC    q  
           Hex.      1B   71  
           Decimal   27  113

[Defined Area]    - - -

[Initial Value]   JIS Kanji character mode cancelled

[Function]        Cancel JIS Kanji character mode

This command is ignored when UTF-8 is specified (command: ESC GS t 128) for MBCS.

#### ESC \$ n

[Name] Specify/cancel Shift JIS Kanji character mode  
 [Code] ASCII      ESC    \$    n  
           Hex.      1B   24   n  
           Decimal   27   36   n

[Defined Area]    - - -

[Initial Value]   Memory switch / Star Configuration setting

[Function]        Specifies and cancels the shift JIS Kanji character mode.

When in shift JIS Kanji character mode, character codes are all handled as 2-byte Kanji characters (First byte: upper code; second byte: lower code).

This command is ignored for models not equipped with Japanese and Kanji characters and when the specification for the location of use is specified as SBCS (single byte countries) by the memory switch / Star Configuration.

This command is ignored when UTF-8 is specified (command: ESC GS t 128) for MBCS.

n	Shift JIS Kanji character mode
0, 48	Cancels shift JIS Kanji character mode
1, 49	Specifies shift JIS Kanji character mode

## ESC s n1 n2

[Name]	Set Full-Size Kanji character left/right spaces				
[Code]	ASCII	ESC	s	n1	n2
	Hex.	1B	73	n1	n2
	Decimal	27	115	n1	n2

[Defined Area]      $0 \leq n1 \leq 7$   
                            $48 \leq n1 \leq 55$  ("0"  $\leq$  n1  $\leq$  "7")  
                            $0 \leq n2 \leq 15$   
                            $48 \leq n2 \leq 57$  ("0"  $\leq$  n2  $\leq$  "9")  
                            $65 \leq n2 \leq 70$  ("A"  $\leq$  n2  $\leq$  "F")

[Initial Value]    Memory switch / Star Configuration setting

[Function]         Adds n1 dots left space amount and n2 dots right space amount to Kanji characters.  
 The Kanji character width is "left space amount" + "Kanji font dot count" + "right space amount."  
 (See the information on character specifications in the appropriate printer specifications manual for details on the Kanji font dot count.)  
 This command is ignored for models not equipped with Kanji fonts (for overseas) and when the specification for the location of use is specified as SBCS (single byte countries) by the memory switch / Star Configuration.

Standard mode and page mode can be set independently of each other.

## ESC t n1 n2

[Name]	Set Half-Size Kanji character left/right spaces				
[Code]	ASCII	ESC	t	n1	n2
	Hex.	1B	74	n1	n2
	Decimal	27	116	n1	n2

[Defined Area]      $0 \leq n1 \leq 7$   
                            $48 \leq n1 \leq 55$  ("0"  $\leq$  n1  $\leq$  "7")  
                            $0 \leq n2 \leq 15$   
                            $48 \leq n2 \leq 57$  ("0"  $\leq$  n2  $\leq$  "9")  
                            $65 \leq n2 \leq 70$  ("A"  $\leq$  n2  $\leq$  "F")

[Initial Value]    Memory switch / Star Configuration setting

[Function]         Adds n1 dots left space amount and n2 dots right space amount to half-size Kanji characters.  
 The half-size Kanji character width is "left space amount" + "half-size Kanji font dot count" + "right Space amount."  
 (See the information on character specifications in the appropriate printer specifications manual for details on the half-size Kanji font dot count.)  
 This command is ignored for models not equipped with Kanji fonts (for overseas) and when the specification for the location of use is specified as SBCS (single byte countries) by the memory switch / Star Configuration.

Standard mode and page mode can be set independently of each other.

## ESC r c1 c2 d1...dk

[Name]	Register Kanji download characters							
[Code]	ASCII	ESC	r	c1	c2	d1	...	dk
	Hex.	1B	72	c1	c2	d1	...	dk
	Decimal	27	114	c1	c2	d1	...	dk

[Defined Area]  $0 \leq d \leq 255$

$k=72$

c1 and c2 differ according to specifications and code type (see table below).

[Initial Value] All spaces

[Function] Registers Kanji download characters to c1 and c2 addresses.

Those already registered to these addresses are overwritten. If c1 and c2 are outside of the defined area or the printer is model not equipped with Kanji fonts (for overseas) and when the specification for the location of use is specified as SBCS (single byte countries) by the memory switch / Star Configuration, the printer discards up to d1 and dk.

Specification	c1	c2	Registration count
Japanese char./JIS type	c1=77h	$21h \leq c2 \leq 7Eh$	94 characters
Japanese char./Shift JIS type	c1=ECh	$40h \leq c2 \leq 7Eh$ $80h \leq c2 \leq 9Eh$	94 characters
Kanji characters	c1=FEh	$A1h \leq c2 \leq FEh$	94 characters
Taiwan char./JIS type	c1=FEh	$A1h \leq c2 \leq FEh$	94 characters
Hangeul char./JIS type	c1=FEh	$A1h \leq c2 \leq FEh$	94 characters

(\*) The registration region is the same for Japanese characters in JIS or shift JIS.

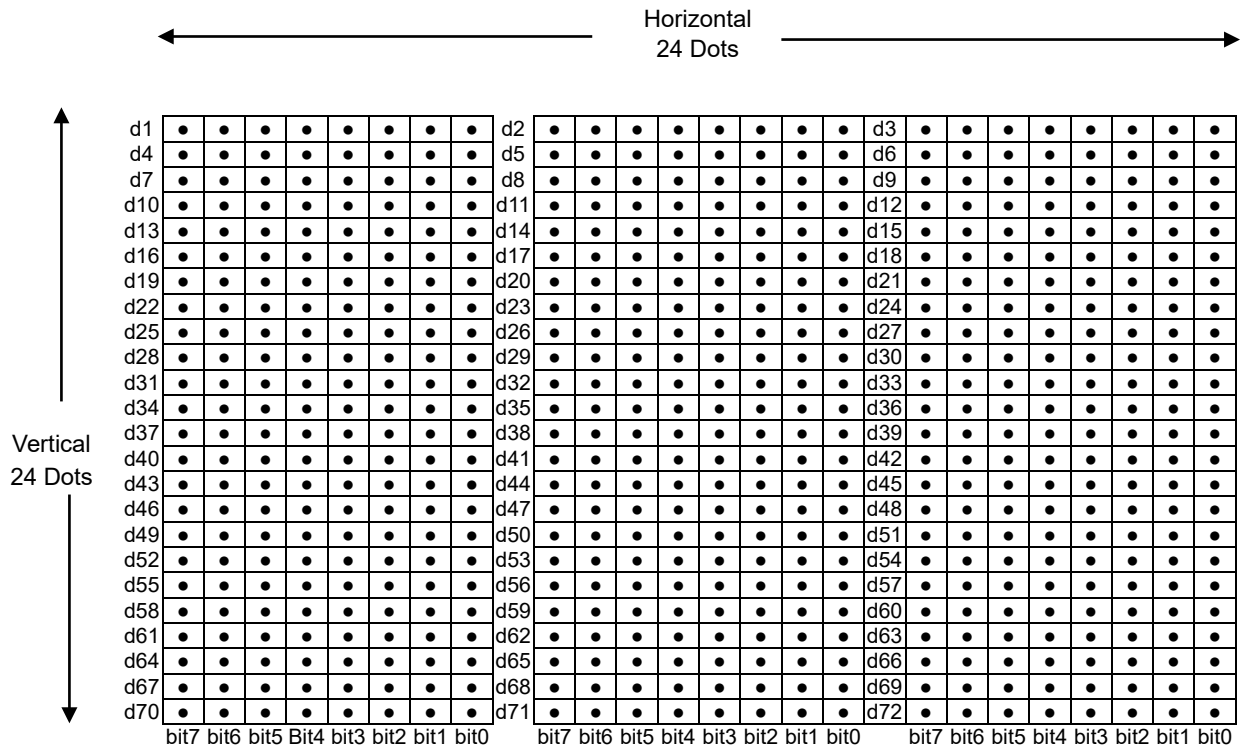



### 2.3.3. Print Mode

#### ESC i n1 n2

[Name] Set/cancel the double wide/high  
 [Code] ASCII ESC i n1 n2  
 Hex. 1B 69 n1 n2  
 Decimal 27 105 n1 n2

[Defined Area]  $0 \leq n1 \leq 5$   
 $48 \leq n1 \leq 53$  ("0"  $\leq n1 \leq$  "5")  
 $0 \leq n2 \leq 5$   
 $48 \leq n2 \leq 53$  ("0"  $\leq n2 \leq$  "5")

[Initial Value] n1 = 0 (Double high cancelled)  
 n2 = 0 (Double wide cancelled)

[Function] Specifies/cancels double high/wide for ANK characters and Kanji characters.  
 This command is ignored if either n1 or n2 is outside of the defined area.

n1	Expanded high
0, 48	Cancels expanded high
1, 49	Specifies 2x high expansion
2, 50	Specifies 3x high expansion
3, 51	Specifies 4x high expansion
4, 52	Specifies 5x high expansion
5, 53	Specifies 6x high expansion

n2	Expanded wide
0, 48	Cancels expanded wide
1, 49	Specifies 2x wide expansion
2, 50	Specifies 3x wide expansion
3, 51	Specifies 4x wide expansion
4, 52	Specifies 5x wide expansion
5, 53	Specifies 6x wide expansion

[Model limitation]

SM-L200 : 4x high expansion, 5x high expansion, and 6x high expansion are not supported in the expanded high that is specified with n1.

$0 \leq n1 \leq 2$ ,  $48 \leq n1 \leq 50$  ("0"  $\leq n1 \leq$  "2")

## ESC W n

[Name] Specify/cancel expanded wide  
 [Code] ASCII      ESC    W    n  
           Hex.      1B   57   n  
           Decimal    27   87   n

[Defined Area]       $0 \leq n \leq 5$

$48 \leq n \leq 53$  ("0"  $\leq n \leq$  "5")

[Initial Value]     n = 0 (Double wide cancelled)

[Function]          Specifies/cancels double wide for ANK characters and Kanji characters.

n	Expanded wide
0, 48	Cancels expanded wide
1, 49	Specifies 2x wide expansion
2, 50	Specifies 3x wide expansion
3, 51	Specifies 4x wide expansion
4, 52	Specifies 5x wide expansion
5, 53	Specifies 6x wide expansion

## ESC h n

[Name] Specify/cancel expanded high  
 [Code] ASCII      ESC    h    n  
           Hex.      1B   68   n  
           Decimal    27   104   n

[Defined Area]       $0 \leq n \leq 5$

$48 \leq n \leq 53$  ("0"  $\leq n \leq$  "5")

[Initial Value]     n = 0 (Double high cancelled)

[Function]          Specifies/cancels double high for ANK characters and Kanji characters.

n	Expanded high
0, 48	Cancels expanded high
1, 49	Specifies 2x expansion
2, 50	Specifies 3x expansion
3, 51	Specifies 4x expansion
4, 52	Specifies 5x expansion
5, 53	Specifies 6x expansion

[Model limitation]

SM-L200 : 4x high expansion, 5x high expansion, and 6x high expansion are not supported.

$0 \leq n1 \leq 2$ ,  $48 \leq n1 \leq 50$  ("0"  $\leq n1 \leq$  "2")

## **ESC E**

[Name] Select emphasized printing  
 [Code] ASCII      ESC   E  
           Hex.       1B  45  
           Decimal    27  69

[Defined Area]    - - -

[Initial Value]   Emphasized printing selected

[Function]        Specifies emphasized printing for ANK characters and Kanji characters.  
                   IBM block ignores emphasized printing.

## **ESC F**

[Name] Cancel emphasized printing  
 [Code] ASCII      ESC   F  
           Hex.       1B  46  
           Decimal    27  70

[Defined Area]    - - -

[Initial Value]   Emphasized printing cancelled.

[Function]        Cancels emphasized printing for ANK and Kanji characters.

## ESC - n

[Name] Select/cancels underling mode  
 [Code] ASCII ESC - n  
 Hex. 1B 2D n  
 Decimal 27 45 n

[Defined Area] n = 0, 1, 48, 49

[Initial Value] n = 0 (Underline cancelled)

[Function] Specifies underlining (2 dots).  
 Underlines are composed of 2 dot lines.  
 Underlines are not applied to horizontal tabs and to specified horizontal direction positions.  
 Underlines are expanded if the character expansion is specified. (When double high expansion is used, underlines are composed of 4 dots.)  
 Underlines are enabled for white/black inversion.  
 This command is enabled for ANK characters and Kanji characters.  
 IBM block ignores underlines.

n	Underline
0, 48	Cancels underline
1, 49	Specifies underline

## ESC \_ n

[Name] Specify/cancel upperline  
 [Code] ASCII ESC \_ n  
 Hex. 1B 5 n  
 F  
 Decimal 27 9 n  
 5

[Defined Area] n = 0, 1, 48, 49

[Initial Value] n = 0 (Upperline cancelled)

[Function] Specifies upperlining (2 dots).  
 Upperlines are composed of 2 dot lines.  
 Upperlines are not applied to horizontal tabs and to specified horizontal direction positions.  
 Upperlines are expanded if the character expansion is specified. (When double high expansion is used, upperlines are composed of 4 dots.)  
 Upperlines are enabled for white/black inversion.  
 This command is enabled for ANK characters and Kanji characters.  
 IBM block ignores upperlines.

n	Upperline
0, 48	Cancels upperline
1, 49	Specifies upperline

## **ESC 4**

[Name] Select white/black inverted printing  
 [Code] ASCII       ESC    4  
           Hex.       1B   34  
           Decimal    27   52

[Defined Area]    - - -

[Initial Value]   White/black inversion cancelled

[Function]        Specifies white/black inversion for ANK characters and Kanji characters.  
                   IBM block ignores white/black inversion.

## **ESC 5**

[Name] Cancel white/black inversion  
 [Code] ASCII       ESC    5  
           Hex.       1B   35  
           Decimal    27   53

[Defined Area]    - - -

[Initial Value]   White/black inversion cancelled

[Function]        Cancels white/black inversion for ANK characters and Kanji characters.

## SI

[Name] Select upside-down printing  
 [Code] ASCII SI  
 Hex. 0F  
 Decimal 15

[Defined Area] - - -

[Initial Value] Upside-down cancelled

[Function] Specifies upside-down printing

This command is enabled only when at the top of the line.

Upside down and right-side up characters cannot both exist in the same line.

This command is enabled for following.

- ANK characters
- Kanji characters
- Bit images
- Logos
- Bar codes

This command setting does not affect page mode. When page mode is selected, only the setting of this command is enabled.

## DC2

[Name] Cancel upside-down printing  
 [Code] ASCII DC2  
 Hex. 12  
 Decimal 18

[Defined Area] - - -

[Initial Value] Upside-down printing cancelled

[Function] Cancels upside-down printing

This command is enabled only when at the top of the line.

This command setting does not affect page mode. When page mode is selected, only the setting of this command is enabled.

### 2.3.4. Horizontal Direction Printing Position

#### ESC I n

[Name]	Set left margin			
[Code]	ASCII	ESC	I	n
	Hex.	1B	6C	n
	Decimal	27	108	n

[Defined Area]  $0 \leq n \leq 255$

[Initial Value]  $n = 0$

[Function] Uses the left edge as a standard to set the left margin as (current ANK character pitch x n). Character pitch includes the space between characters and expansion settings are enabled. The left margin set using this command is unaffected by changing the character pitch. This command is ignored if settings are for a printing region less than 36 mm.

Setting this command partway will take affect from the next line.

This command setting does not affect page mode. When page mode is selected, only the setting of this command is enabled.

#### ESC Q n

[Name]	Set right margin			
[Code]	ASCII	ESC	Q	n
	Hex.	1B	51	n
	Decimal	27	81	n

[Defined Area]  $0 \leq n \leq 255$

[Initial Value] - - -

[Function] Uses the left edge as a standard to set the print region as (current ANK character pitch x n). Character pitch includes the space between characters and expansion settings are enabled. The right margin set using this command is unaffected by changing the character pitch. This command is ignored if settings are for a printing region less than 36 mm.

Setting this command partway will take affect from the next line.

This command setting does not affect page mode. When page mode is selected, only the setting of this command is enabled.

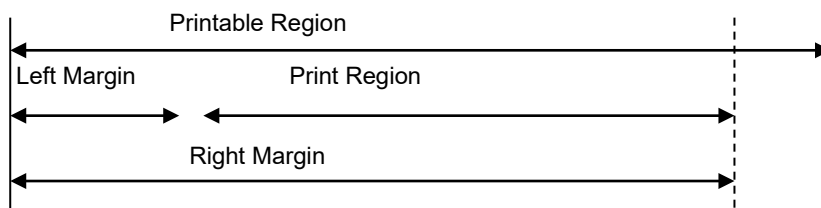

## HT

[Name] Move horizontal tab  
 [Code] ASCII HT  
 Hex. 09  
 Decimal 9

[Defined Area] - - -

[Initial Value] No setting

[Function] Move print position to next horizontal tab position.  
 When a horizontal tab is not set, this command is ignored.  
 In standard mode, when the current position is the same as or to the right of the rightmost horizontal tab position, this command is ignored.  
 In page mode, when the current position is the same as or to the right of the rightmost horizontal tab position that is set in the print area, a line feed is performed.

## ESC D n1 n2...nk NUL

[Name] Set horizontal tab  
 [Code] ASCII ESC D n1 n2 ... nk NUL  
 Hex. 1B 44 n1 n2 ... nk 00  
 Decimal 27 68 n1 n2 ... nk 0

[Defined Area]  $1 \leq n \leq 255$   
 $0 \leq k \leq 16$

[Initial Value] Standard mode : - - -  
 Page mode : 8, 16, 24 ... (16, one every 8 characters at the initially selected ANK character pitch)

[Function] Uses the left edge as a standard to set the horizontal tab to the position of (current ANK character pitch x n).  
 The horizontal tab reference point is the right edge of the paper, regardless of the left margin.  
 ANK character pitch includes the right space and expansion settings are enabled.  
 All other horizontal tabs set before setting the horizontal tab using this command are cancelled  
 The tab position must satisfy the following conditions. If the condition is not satisfied, the data up to the NUL code is discarded.  
 Normal tabs that meet the conditions below are set and tabs after errors occur are not set.  
 -  $k \leq 16$   
 -  $1 < n_1 < n_2 \dots < n_k$   
 -  $n_k \leq \text{Printable region}$  (Only Standard mode)  
 The horizontal tab set using this command is unaffected by changing the character pitch.  
 Horizontal tabs set using the ESC D NUL command are cleared.  
 There is no initial value for the horizontal tab.  
 Standard mode and page mode can be set independently of each other.

## ESC D NUL

[Name] Clear horizontal tab  
 [Code] ASCII ESC D NUL  
 Hex. 1B 44 00  
 Decimal 27 68 0

[Defined Area] - - -

[Initial Value] - - -

[Function] Clears the currently set horizontal tab.  
 Standard mode and page mode can be set independently of each other.



### ESC GS A n1 n2

[Name] Move absolute position  
 [Code] ASCII ESC GS A n1 n2  
 Hex. 1B 1D 41 n1 n2  
 Decimal 27 29 65 n1 n2

[Defined Area]  $0 \leq n1 \leq 255$   
 $0 \leq n2 \leq 255$

[Initial Value] ---

[Function] Moves the printing position from the left margin to the  $(n1 + n2 \times 256)$  position.  
 This command is ignored if the print region is exceeded.  
 If print data is overlapped when moved to the left, the old print data is overwritten by new data.

### ESC GS R n1 n2

[Name] Move relative position  
 [Code] ASCII ESC GS R n1 n2  
 Hex. 1B 1D 52 n1 n2  
 Decimal 27 29 82 n1 n2

[Defined Area]  $0 \leq n1 \leq 255$   
 $0 \leq n2 \leq 255$

[Initial Value] ---

[Function] Moves the printing position from the current position to the  $(n1 + n2 \times 256)$  position.  
 This command is ignored if the print region is exceeded.  
 When  $(n1 + n2 \times 256) \geq 32768$ , it moves  $\{65536 - (n1 + n2 \times 256)\}$  dots in the left direction.  
 When  $(n1 + n2 \times 256) < 32768$ , it moves  $(n1 + n2 \times 256)$  dots in the right direction.  
 If print data is overlapped when moved to the left, the old print data is overwritten by new data.

### ESC GS a n

[Name] Specify position alignment  
 [Code] ASCII ESC GS a n  
 Hex. 1B 1D 61 n  
 Decimal 27 29 97 n

[Defined Area]  $0 \leq n \leq 2$   
 $48 \leq n \leq 50$  ("0"  $\leq n \leq$  "2")

[Initial Value]  $n = 0$

[Function] Specifies the alignment position in the printing region that has been set.  
 This command setting does not affect page mode. When page mode is selected, only the setting of this command is enabled.

n	Position alignment
0, 48	Left alignment
1, 49	Center alignment
2, 50	Right alignment

### 2.3.5. Line Spacing

#### LF

[Name] Line feed  
 [Code] ASCII LF  
 Hex. 0A  
 Decimal 10

[Defined Area] ---

[Initial Value] ---

[Function] Feeds the currently specified amount of paper.  
 If print data exists in the line buffer, it prints that data.  
 Initial value for line feed amount is determined by the memory switch Star Configuration setting .

#### ESC a n

[Name] Feed paper n lines  
 [Code] ASCII ESC a n  
 Hex. 1B 61 n  
 Decimal 27 97 n

[Defined Area]  $1 \leq n \leq 127$

[Initial Value] ---

[Function] Executes a paper feed for (the currently specified line feed amount x n).  
 If print data exists in the line buffer, it prints that data.  
 Initial value for line feed amount is determined by the memory switch Star Configuration setting .

#### ESC z n

[Name] Select line feed amount  
 [Code] ASCII ESC z n  
 Hex. 1B 7A n  
 Decimal 27 122 n

[Defined Area] n = 0, 48

n = 1, 49

[Initial Value] Memory switch / Star Configuration setting

[Function] Specifies the line feed amount.

Standard mode and page mode can be set independently of each other.

n	Line feed amount
0, 48	Specifies 3 mm line feed amount
1, 49	Specifies 4 mm line feed amount

## **ESC 0**

[Name] Specify line spacing to 3 mm  
 [Code] ASCII ESC 0  
 Hex. 1B 30  
 Decimal 27 48

[Defined Area] - - -

[Initial Value] Memory switch / Star Configuration setting

[Function] Specifies the line feed amount to 3 mm.  
 Standard mode and page mode can be set independently of each other.

## **ESC J n**

[Name] n/4 mm line feed  
 [Code] ASCII ESC J n  
 Hex. 1B 4A n  
 Decimal 27 74 n

[Defined Area]  $1 \leq n \leq 255$

[Initial Value] - - -

[Function] Executes a n/4mm paper feed.  
 If print data exists in the line buffer, it prints that data.  
 Using this command will intermittently feed paper, therefore, it is normally recommended that this command not be used.

## **ESC I n**

[Name] n/8mm line feed  
 [Code] ASCII ESC I n  
 Hex. 1B 49 n  
 Decimal 27 73 n

[Defined Area]  $1 \leq n \leq 255$

[Initial Value] - - -

[Function] Executes a n/8mm paper feed.  
 If print data exists in the line buffer, it prints that data.  
 Using this command will intermittently feed paper, therefore, it is normally recommended that this command not be used.

### 2.3.6. Page Control Commands

#### **FF**

[Name]	Form feed		
[Code]	ASCII	FF	
	Hex.	0C	
	Decimal	12	

[Defined Area] ---

[Initial Value] ---

[Function] Executes a form feed.

If the current position is at the top of the page, it form feeds to the top of the next page.

If there is data existing in the line buffer when executing a form feed, it prints that data, then executes the form feed.

However, by printing data remaining in the buffer, and moving to the top of the next page, a form feed is considered to have been executed, so form feed is not performed.

Invalid in page mode.

#### **ESC C n**

[Name]	Set page length to n lines			
[Code]	ASCII	ESC	C	n
	Hex.	1B	43	n
	Decimal	27	67	n

[Defined Area]  $1 \leq n \leq 127$

[Initial Value] (Form feed amount initial value x 42)

[Function] The position whereat this command is processed is considered the top of the page and sets the page length to (current form feed amount x n).

The page length set using this command is unaffected by changing the form feed amount later.

Moving to the top of the page is performed using the following commands.

- Form feed command (FF): Executes a form feed.
- Cutter command (ESC d n): Sets cutter position at top of page.
- Error cancel operations: Sets position when quitting error cancellation operations at top of page.

#### **ESC C NUL n**

[Name]	Set page length to n x 24 mm units				
[Code]	ASCII	ESC	C	NUL	n
	Hex.	1B	43	00	n
	Decimal	27	67	0	n

[Defined Area]  $1 \leq n \leq 22$

[Initial Value] (Form feed amount initial value x 42)

[Function] The position whereat this command is processed is considered the top of the page and sets the page length to (n x 24 mm).

The page length set using this command is unaffected by changing the form feed amount later.

Moving to the top of the page is performed using the following commands.

- Form feed command (FF): Executes a form feed.
- Cutter command (ESC d n): Sets cutter position at top of page.
- Error cancel operations: Sets position when quitting error cancellation operations at top of page.

### 2.3.7. Top margin

#### **ESC RS T n**

[Name]	Set top margin				
[Code]	ASCII	ESC	RS	T	n
	Hex.	1B	1E	54	n
	Decimal	27	30	84	n

[Defined Area] Spec. 1  
 $n = 0, 2 \leq n \leq 11$

Spec. 2  
 $n = 0, 11$

Spec. 3  
 $n = 0, 3, 11$

[Initial Value] Memory switch / Star Configuration setting

[Function] Sets the top margin at n mm from the top edge of the paper.  
 When n=0, the standard top margin for that model is set.

[Model limitation]

mC-Print3 : When the top margin is set to 10 mm or less, the paper length (cut length) should not exceed 50mm.  
 (If the cut paper remains at the paper-exit, a paper jam may occur. There is no limitation when the cut paper is removed.)

### 2.3.8. Page Function

#### **ESC GS h 0 k m n**

[Name]	180° Inversion Function							
[Code]	ASCII	ESC	GS	h	0	k	m	n
	Hex.	1B	1D	68	30	k	m	n
	Decimal	27	29	104	48	k	m	n

[Defined Area]	$0 \leq k \leq 1, m = 0, n = 0$
[Initial Value]	Memory switch / Star Configuration setting
[Function]	Enables/disables the 180° inversion function.

k	180° Inversion Function
0	Disable
1	Enable

#### <180° Inversion Function>

Enables/disables the 180° inversion function.

When the 180° inversion function is enabled, a 180° inversion is executed by the 180° inversion trigger.

However, this function is executed for the print data that fits in the image buffer length.

In case with print data longer than the image buffer length, the 180° inversion function is ignored.

Also, when printing is started by other than the 180° inversion trigger described below, when the print startup control setting is set for each line, during the page mode, or while a macro is being executed, the 180° inversion function is ignored.

This setting will not be cleared by <ESC> @ command.

#### 180° inversion trigger

- Cutter command : <ESC> d n
- FF command : <FF>
- BM detection command : <ESC> d n, <FF>

#### Example of usage

- 1) 180° inversion function enabled : <ESC> <GS> h 0 k m n (k=0x01, m=0x00, n=0x00)
- 2) Print data transmission : Print data (Print length must be within the image buffer length.)
- 3) Trigger command transmission : <ESC> d n (Cutter command is the 180° inversion trigger.)

### 2.3.9. Cutter Control

#### ESC d n

[Name]	Auto-cutter			
[Code]	ASCII	ESC	d	n
	Hex.	1B	64	n
	Decimal	27	100	n

[Defined Area]      $0 \leq n \leq 3$   
 $48 \leq n \leq 51$  ("0"  $\leq n \leq$  "3")  
 n = 116 ("t")

[Initial Value]     - - -

[Function]         Executes the auto-cutter.  
 After auto-cutter is executed, the printer considers that to be the top of the page.

#### Spec. 1

n	Auto cutter
0, 48	Full cut at the current position. If there is print data remaining in the line buffer, printing of line buffer is executed prior to the operation described above.
1, 49	Partial cut at the current position. If there is print data remaining in the line buffer, printing of line buffer is executed prior to the operation described above.
2, 50	Paper is fed to cutting position, then a full cut. If there is print data remaining in the line buffer, printing of line buffer is executed prior to the operation described above.
3, 51	Paper is fed to cutting position, then a partial cut. If there is print data remaining in the line buffer, printing of line buffer is executed prior to the operation described above.
116	Feed paper to the tear bar position. If there is print data remaining in the line buffer, printing of line buffer is executed prior to the operation described above.

#### Spec. 2

n	Auto cutter
0, 48	Full cut at the current position. If there is print data remaining in the line buffer, printing of line buffer is executed prior to the operation described above.
1, 49	Partial cut at the current position. If there is print data remaining in the line buffer, printing of line buffer is executed prior to the operation described above.
2, 50	Paper is fed to cutting position, then a full cut. If there is print data remaining in the line buffer, printing of line buffer is executed prior to the operation described above.
3, 51	Paper is fed to cutting position, then a partial cut. If there is print data remaining in the line buffer, printing of line buffer is executed prior to the operation described above.

- (\*) The auto-cutter function operates in the following ways on models that only have a full cut or a partial cut.
- Models that perform only a full cut. : Executes a full cut when there are instructions calling for a partial cut.
  - Models that perform only a partial cut. : Executes a partial cut when there are for instructions calling for a full cut.
- (\*) The printer which is not equipped with an auto-cutter works in the following ways.
- Command for full cut at the current position : Executes printing
  - Command for feeding paper to cutting position: Executes printing and feeds paper to the tear bar position.

### 2.3.10. Reduced Printing Function Command Details

#### **ESC GS c h v**

[Name]	Set reduced printing					
[Code]	ASCII	ESC	GS	c	h	v
	Hexadecimal	1B	1D	63	h	v
	Decimal	27	29	99	h	v

#### Spec.1

[Defined Area]	h = 0, 1
	v = 0

#### Spec.2

[Defined Area]	h = 0, 1
	v = 0, 1, 2

[Initial Value] Memory switch / Star Configuration setting

h	Set horizontal direction reduced printing
0	Invalid
1	Valid (67%)
2 to 255	Command ignored

v	Set vertical direction reduced printing
0	Invalid
1	Valid (50%)
2	Valid (75%)
3 to 255	Command ignored

- Reduced printing in the horizontal direction compresses the entire horizontal direction.
- Reduced printing in the horizontal direction with the 3-inch model is enabled when the printing region is 72 mm.
- Disabled in Page Mode.



### 2.3.11. Page Mode Command Details

#### **ESC GS P 0**

[Name]	Selects page mode				
[Code]	ASCII	ESC	GS	P	0
	Hexadecimal	1B	1D	50	30
	Decimal	27	29	80	48

[Function] Switches from standard mode to page mode.

- Valid only when input at the top of the line.
- Invalid when input in page mode.
- Returns to standard mode after running this command.
  - ESC GS P 1 (selects standard mode)
  - ESC GS P 7 (prints in page mode and recovers)
- The character expansion position uses the starting point specified by ESC GS P2 (selection of character print direction in page mode) in the print region specified by ESC GS P 3 (set print region in page mode).
- Switches the following command setting values that have independent values for both page and standard modes to the setting values of page mode.
  - Set space amount : ESC SP, ESC s, ESC t
  - Set the line feed amount t : ESC z, ESC 0
  - Set horizontal tab : ESC D
- The following commands are valid in page mode.
  - ESC GS a : Move absolute position
  - SI : Select upside-down printing
  - ESC I : Set left margin
  - ESC Q : Set right margin
- The following commands are invalid in page mode.
  - FF : Form feed
  - ESC GS c : Reduced Printing
  - ESC RS m : BM setting
  - ESC RS A : Printing Region Setting
  - ESC GS M : Maintenance counter control
  - ESC GS r : Get CRC
  - ESC RS C : Set printing mode
  - ESC RS r : Set print speed
  - ESC GS S : Print raster graphics data
- Recover to standard mode using ESC @ (initialize printer).

## ESC GS P 1

[Name] Cancel page mode  
 [Code] ASCII       ESC   GS   P   1  
           Hexadecimal 1B  1D  50 31  
           Decimal     27  29  80 49

[Function] Cancels page mode.

- Valid only when input in page mode.
- Data expanded in page mode is erased.
- After execution, the top of the line is positioned at the next print starting position.
- Print region set by ESC GS P 3 (Set print region in page mode) is initialized.
- Switches the following command setting values that have independent values for both standard and page modes to the setting values of standard mode.
  - Set space amount               : ESC SP, ESC s, ESC t
  - Set the line feed amount       : ESC z, ESC 0
  - Set horizontal tab               : ESC D
- The following commands are valid only when set in standard mode.
  - ESC GS P 3                       : Set print region in page mode
  - ESC GS P 2                       : Select character print direction in page mode
- The following commands are ignored in standard mode.
  - ESC GS P 4                       : Specify character vertical direction absolute position in page mode
  - ESC GS P 5                       : Specify character vertical direction relative position in page mode
  - ESC GS P 6                       : Print data in page mode
  - ESC GS P 7                       : Print in page mode and recover
  - ESC GS P 8                       : Cancel print data in page mode
- When power is turned on and when a reset is implemented, standard mode is selected when executing initialization (ESC @) of the printer.

## ESC GS P 2 n

[Name] Select character print direction in page mode  
 [Code] ASCII       ESC GS P   2  
           Hexadecimal 1B 1D 50  32  
           Decimal     27 29 80  50

[Defined Area]      $0 \leq n \leq 3, 48 \leq n \leq 51$   
 [Initial Value]     $n = 0$   
 [Function]         Select character print direction and starting point in page mode.

N	Printing Direction	Starting Point
0, 48	Left to Right	Upper Left (Drawing at Right A)
1, 49	Bottom to Top	Bottom Left (Drawing at Right B)
2, 50	Right to Left	Bottom Right (Drawing at Right C)
3, 51	Top to Bottom	Top Right (Drawing at Right D)

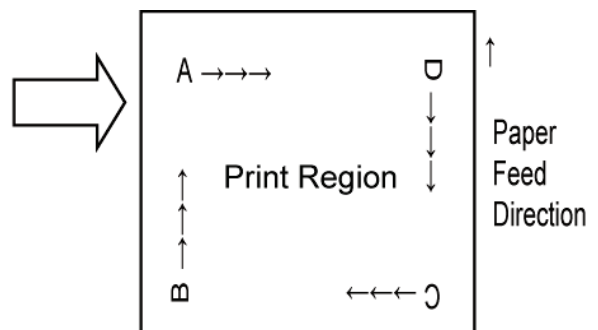

- When standard mode is selected, only internal printer flag operations are executed when this command is entered. In that case, printing in standard mode is unaffected.
- The starting point in the print region specified by ESC GS P 3 (Set print region in page mode) is used for the start of character expansion.

## ESC GS P 3 xL xH yL yH dxL dxH dyL dyH

[Name] Set print region in page mode

[Code]	ASCII	ESC GS P	3
	Hexadecimal	1B 1D 50	33
	Decimal	27 29 80	51

[Defined Area]  $0 \leq xL, xH, yL, yH, dxL, dxH, dyL, dyH \leq 255$   
 However, this excludes  $dxL = dxH = 0$  or  $dyL = dyH = 0$ .

[Initial Value]  $xL = xH = yL = yH = 0$

For  $dxL, dxH, dyL,$  and  $dyH,$  refer to "Page Mode Print Maximum Region" listed in Appendix 6.

[Function] Set print region in page mode

Sets the position and size of the print region.

- Horizontal starting point =  $[(xL + xH \times 256) \times 1/8]$  mm
- Vertical starting point =  $[(yL + yH \times 256) \times 1/8]$  mm
- Horizontal direction length =  $[(dxL + dxH \times 256) \times 1/8]$  mm
- Vertical direction length =  $[(dyL + dyH \times 256) \times 1/8]$  mm
- When standard mode is selected, only internal printer flag operations are executed when this

command

is entered. Has no affect on printing.

- If the horizontal or vertical starting point is outside of the print region, invalidate all settings.
- If the horizontal or vertical length direction is 0, invalidate all settings.
- The character expansion starting point is the one specified by the selection of the character printing direction (ESC GS P 2) in page mode in the print region.
- If the (horizontal direction starting point + horizontal direction length) exceeds the horizontal direction printable region, the (horizontal direction printable region – horizontal direction starting point)

becomes

the horizontal direction length.

- If the (vertical direction starting point + vertical direction length) exceeds the vertical direction printable region, the (vertical direction printable region – vertical direction starting point) becomes the vertical direction length.
- If the calculated results is a fraction that is corrected to the minimum mechanical pitch and excess is discarded.

See [Appendix 5](#) for details on the maximum and minimum of the specified print region.

## **ESC GS P 4 nL nH**

[Name] Specify character vertical direction absolute position in page mode

[Code]	ASCII	ESC	GS	P	4
	Hexadecimal	1B	1D	50	34
	Decimal	27	29	80	52

[Defined Area]  $0 \leq nL \leq 255, 0 \leq nH \leq 255$

[Initial Value] - - -

[Function] Specify the position for character vertical direction of the data expansion starting position in page mode with the absolute position that uses the starting point as a reference.  
 The position of the character vertical direction of the starting position for subsequent data expansion uses the position from the starting point  $[(nL + nH \times 256) \times 1/8]$  mm.

- This command is ignored when page mode is not selected.
- Absolute position specifications that exceed the specified print region are ignored.
- The position of the character horizontal direction of the data expansion starting position does not move.
- Specify the reference starting point using ESC GS P 2.
- The following operations will occur depending on the starting point of ESC GS P 2 (select character print direction in page mode).
  - a. When the starting point is “upper left” or “bottom right,” specify the absolute position of the paper feed direction.
  - b. When the starting point is “upper right” or “bottom left,” specify the absolute position of the perpendicular direction to the paper feed.
- If the calculated results is a fraction that is corrected to the minimum mechanical pitch and excess is discarded.

## **ESC GS P 5 nL nH**

[Name] Specify character vertical direction relative position in page mode

[Code]	ASCII	ESC	GS	P	5
	Hexadecimal	1B	1D	50	35
	Decimal	27	29	80	53

[Defined Area]  $0 \leq nL \leq 255, 0 \leq nH \leq 255$

[Initial Value] - - -

[Function] Specify the position for character vertical direction of the data expansion starting position in page mode with the relative position that uses the current position as a reference.  
 The subsequent data expansion starting position uses the position moved  $[(nL + nH \times 256) \times 1/8]$  mm from the current position.

- This command is ignored when page mode is not selected.
- When specifying the characters downward from the current position the value is positive (plus); when specifying upward, the value is negative (minus).
- Negative numbers are represented by a complement of 65536. For example, use the following to move upward N pitches.
 
$$nL + nH \times 256 = 65536 - N$$
- Relative position specifications that exceed the specified print region are ignored.
- The following operations will occur depending on the ESC GS P 2 (select character print direction in page mode).
  - a. When the starting point is “upper left” or “bottom right,” specify the absolute position of the paper feed direction.
  - b. When the starting point is “upper right” or “bottom left,” specify the relative position of the perpendicular direction to the paper feed.
- If the calculated results are a fraction that is corrected to the minimum mechanical pitch and excess is discarded.

## ESC GS P 6

[Name] Print data in page mode  
 [Code] ASCII           ESC GS P 6  
           Hexadecimal   1B 1D 50 36  
           Decimal        27 29 80 54

[Function]           Lump-prints data expanded to the entire print region in page mode.

- Valid only when page mode is selected.
- After printing, the following information is maintained.
  - a. Expanded data
  - b. Selection of character print direction in page mode (ESC GS P 2)
  - c. Setting of print region in page mode (ESC GS P 3)
  - d. Character expansion position

[Model Limitations] SM-L, S and T Series : After printing, the information of “a. Expanded data” and “d. Character expansion position is cleared.

## ESC GS P 7

[Name] Print in page mode and recover  
 [Code] ASCII           ESC GS P 7  
           Hexadecimal   1B 1D 50 37  
           Decimal        27 29 80 55

[Function]           Lump-prints data expanded to the entire print region and recovers to standard mode.

- All expanded data is erased after printing.
- Print region set by ESC GS P 3 (Set print region in page mode) is initialized.
- No paper cut is executed.
- After execution, the top of the line is positioned at the next print starting position.
- Valid only when page mode is selected.

## ESC GS P 8

[Name] Cancel print data in page mode  
 [Code] ASCII           ESC GS P 8  
           Hexadecimal   1B 1D 50 38  
           Decimal        27 29 80 56

[Function]           Erases all data in presently set print region, in page mode.

- Valid only when page mode is selected.
- Portion included in the currently set print region is deleted even if data of the print region set previously.

### 2.3.12. Bit Image Graphics

#### ESC K n1 n2 d1...dk

[Name]	Standard density bit image							
[Code]	ASCII	ESC	K	n1	n2	d1	...	dk
	Hex.	1B	4B	n1	n2	d1	...	dk
	Decimal	27	75	n1	n2	d1	...	dk

[Defined Area]  $1 \leq \{(n1 + n2 \times 256) \times 3\} \leq$  printable region  
 $k = (n1 + n2 \times 256)$   
 $0 \leq d \leq 255$

[Initial Value] - - -

[Function] Prints bit images using 3 dots wide and 3 dots high per 1 dot of input data.  
 The following shows the data processing in this command.

- When  $\{(n1 + n2 \times 256) \times 3\}$  exceeds the printable region that is currently set, only the data in the printing region is printed.  
 At this time, all data for the print region is discarded.
- In standard mode, if the current position already exceeds the print region, this command discards all data.
- In page mode, if the current position already exceeds the print region, printing is performed after a line feed.

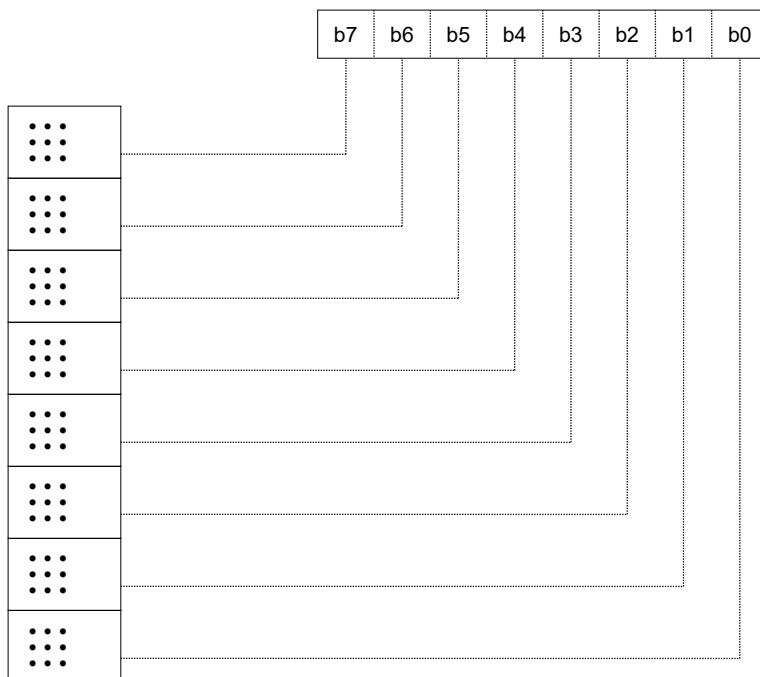

## ESC L n1 n2 d1...dk

[Name]	Standard density bit image							
[Code]	ASCII	ESC	L	n1	n2	d1	...	dk
	Hex.	1B	4C	n1	n2	d1	...	dk
	Decimal	27	76	n1	n2	d1	...	dk

[Defined Area]  $1 \leq (n1 + n2 \times 256) \leq$  printable region  
 $k = (n1 + n2 \times 256)$   
 $0 \leq d \leq 255$

[Initial Value] ---

[Function] Prints bit images using 1 dot wide and 3 dots high per 1 dot of input data.  
 The following shows the data processing in this command.

- When  $(n1 + n2 \times 256)$  exceeds the printable region that is currently set, only the data in the printing region is printed.  
 At this time, all data for the print region is discarded.
- In standard mode, if the current position already exceeds the print region, this command discards all data.
- In page mode, if the current position already exceeds the print region, printing is performed after a line feed.

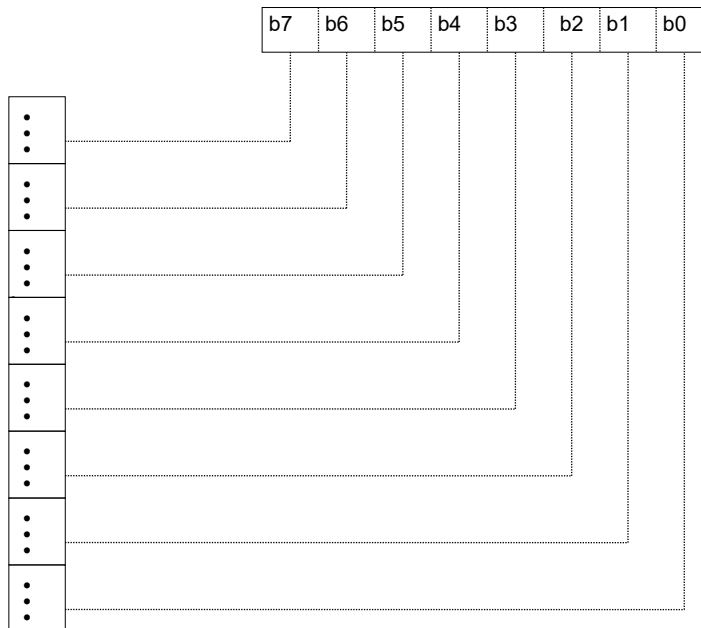

### ESC k n1 n2 d1...dk

[Name]	Fine density bit image						
[Code]	ASCII	ESC	k	n1	n2	d1	... dk
	Hex.	1B	6B	n1	n2	d1	... dk
	Decimal	27	107	n1	n2	d1	... dk

[Defined Area]     n2 = 0  
 $1 \leq \{(n1 + n2 \times 256) \times 8\} \leq$  printable region  
 $k = \{(n1 + n2 \times 256) \times 24\}$   
 $0 \leq d \leq 255$

[Initial Value]     - - -

[Function]         Prints bit images using 1 dot wide and 1 dot high per 1 dot of input data.  
 The following shows the data processing in this command.

- When  $\{(n1 + n2 \times 256) \times 8\}$  exceeds the printable region that is currently set, only the data in the printing region is printed.  
 At this time, all data for the print region is discarded.
- In standard mode, if the current position already exceeds the print region, this command discards all data.
- In page mode, if the current position already exceeds the print region, printing is performed after a line feed.

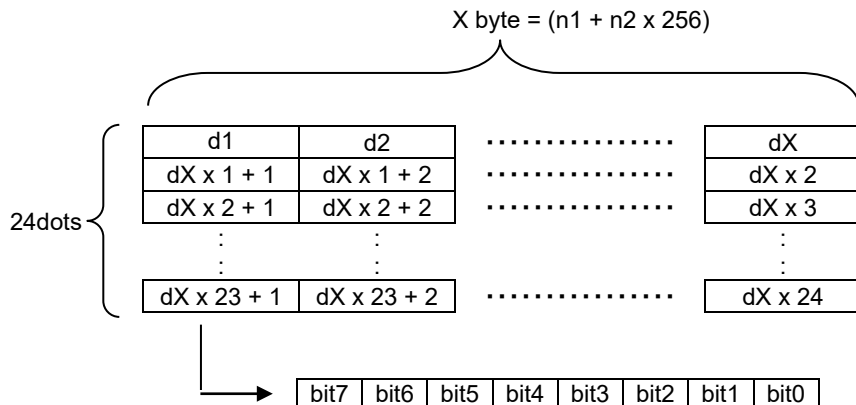



## ESC X n1 n2 d1...dk

[Name]	Fine density bit image (Compatible with 24 bit wire dots)							
[Code]	ASCII	ESC	X	n1	n2	d1	...	dk
	Hex.	1B	58	n1	n2	d1	...	dk
	Decimal	27	88	n1	n2	d1	...	dk

[Defined Area]  $1 \leq (n1 + n2 \times 256) \leq$  printable region  
 $k = \{(n1 + n2 \times 256) \times 3\}$   
 $0 \leq d \leq 255$

[Initial Value] ---

[Function] Prints input bit images with 8 dots/mm resolution for both horizontal and vertical.  
 The following shows the data processing in this command.

- When  $\{(n1 + n2 \times 256) \times 3\}$  exceeds the printable region that is currently set, only the data in the printing region is printed.  
 At this time, all data for the print region is discarded.
- In standard mode, if the current position already exceeds the print region, this command discards all data.
- In page mode, if the current position already exceeds the print region, printing is performed after a line feed.

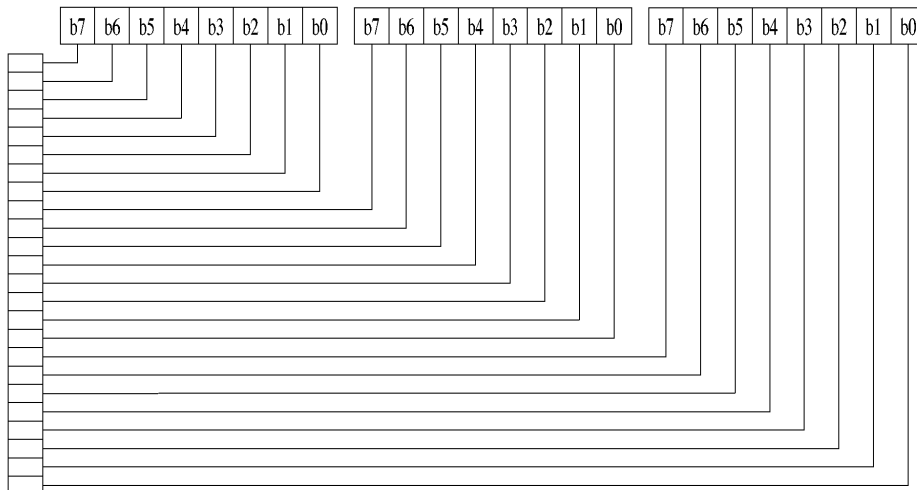

## ESC GS S m xL xH yL yH n [d1 d2...dk]

[Name] Print raster graphics data

[Code] ASCII ESC GS S m xL xH yL yH n d1 d2 ... dk  
 Hex. 1B 1D 53 m xL xH yL yH n d1 d2 ... dk  
 Decimal 27 29 83 m xL xH yL yH n d1 d2 ... dk

[Defined Area] m=1 n=0  
 $0 \leq xL \leq 255, 0 \leq xH \leq 1, 0 \leq yL \leq 255, 0 \leq yH \leq 255$   
 $m=1, 2 : 1 \leq (xL + xH \times 256) \leq 128$   
 $1 \leq (yL + yH \times 256) \leq 65535$   
 $0 \leq d \leq 255$   
 $k=(xL + xH \times 256) \times (yL + yH \times 256)$

[Initial Value] - - -

[Function] Print raster graphics data  
 "m" specifies the number of transfer blocks and the tone.  
 Disabled in Page Mode.

m	Number of transfer blocks	Tones
1	1Block (when single color)	Monochrome printing (2 tones): 1 bit / 1 dot

n: Print color

n	Print color
0	Black

$(xL + xH \times 256)$  specifies the number of horizontal data bytes ((a number of dots x a number of bits per dot\*/8, +1 if not divisible).

$(yL + yH \times 256)$  specifies the number of dots in the vertical direction.

k indicates the number of data.

(d1 d2.....dk) specifies the image data to define.

- 2 tones: 0 /1 (OFF/ON)

When parameter is disabled:

- parameter m: Command processing end (ESC GS S m).
- parameter n: n=0
- parameter xL, xH, yL, yH: Command processing end (ESC GS S m xL xH yL yH)

[Model Limitation]

SM-L series : The maximum value for the number of data dots in the vertical direction is 3200 dots.  
 $(1 \leq (yL + yH \times 256) \leq 3200)$

<Example of Command Transmission>

Monochrome printing (2 tones), data (horizontal:64 dot, vertical:10 dot)

ESC GS S m xL xH yL yH n [d1 d2. . . . . dk] (m=1,n=0)  
 2 tones, black data

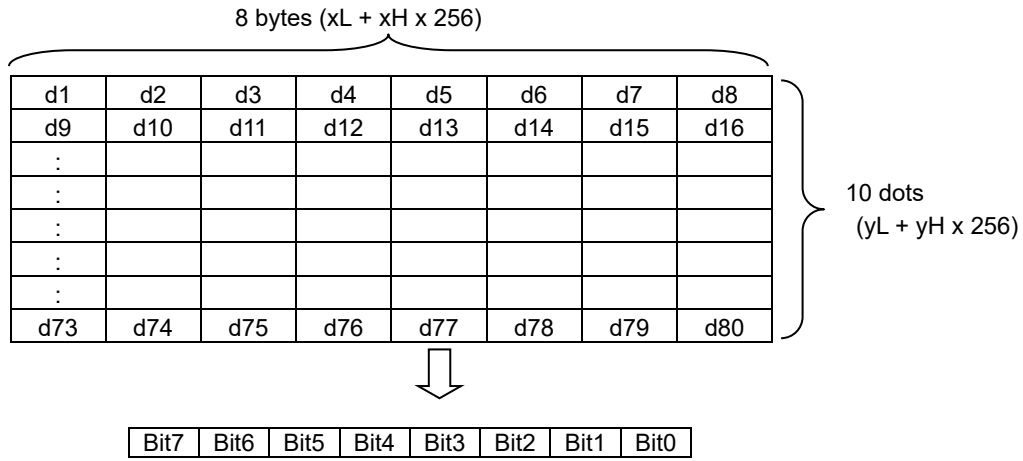

## ESC GS X m xL xH yL yH p1 p2 p3 p4 n [d1 d2...dk]

[Name]	Graphics Raster data printing (Compress data)																	
[Code]	ASCII	ESC	GS	X	m	xL	xH	yL	yH	p1	p2	p3	p4	n	d1	d2	...	dk
	Hexadecimal	1B	1D	58	m	xL	xH	yL	yH	p1	p2	p3	p4	n	d1	d2	...	dk
	Decimal	27	29	88	m	xL	xH	yL	yH	p1	p2	p3	p4	n	d1	d2	...	dk

[Defined Region]     $m = 1, n = 0$   
 $0 \leq xL \leq 255, xH = 0, 0 \leq yL \leq 255, 0 \leq yH \leq 9$   
 $1 \leq (xL + xH \times 256) \leq 128$   
 $1 \leq (yL + yH \times 256) \leq 800$   
 $0 \leq d \leq 255$   
 $k = (p1 + p2 \times 256 + p3 \times 65536 + p4 \times 16777216)$

[Function]            Graphics Raster data printing (Compress data)  
 "m" specifies the number of transfer blocks.  
 "n" specifies the Print color  
 $(xL + xH \times 256)$  specifies the number of horizontal data bytes before compression ((a number of dots x a number of bits per dot\*/8, +1 if not divisible).  
 $(yL + yH \times 256)$  specifies the number of dots in the vertical direction before compression.  
 K: Compressed data count  
 d1 d2 . . . dk specifies the compressed data.

<Data>

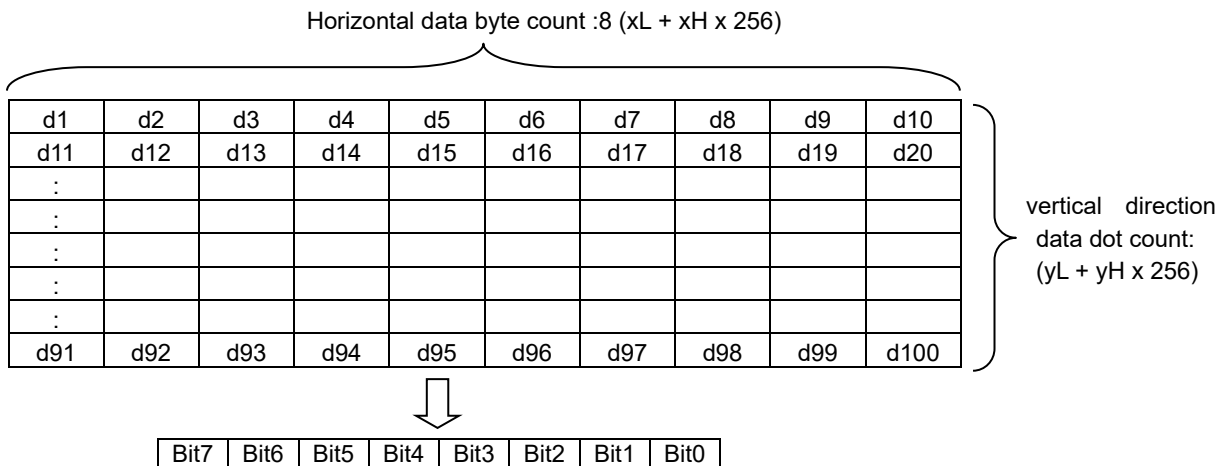

<Algorithm of compression>

Data after compression is composed of a packet containing a byte header and subsequent data.

Header Byte (h)	Data following the header byte
0 to 127	(1+h) pieces of discontinuous byte data
-1 to -127	A byte data repeated (1-h) times in the data before compression
-128	None (Treat the next byte as a header byte)

Data (before compression):

00 00 00 00 08 00 00 80 00 08 00 00 80 00 08 00 00 80 FF FF FF FF FF FF FF FF FF FF FF FF FF FF FF

Compressed data:

FD 00 00 08 FF 00 02 80 00 08 FF 00 02 80 00 08 FF 00 00 80 F3 FF

**2.3.13. Logo**
**ESC GS ( L pL pH m fn [parameter]**
**ESC GS 8 L p1 p2 p3 p4 m fn [parameter]**

[Name] Specify graphics data

[Code] ASCII ESC GS ( L pL pH m fn [parameter]  
 Hexadecimal 1B 1D 28 4C pL pH m fn [parameter]  
 Decimal 27 29 40 76 pL pH m fn [parameter]

[Name] Specify graphics data

[Code] ASCII ESC GS 8 L p1 p2 p3 p4 m fn [parameter]  
 Hexadecimal 1B 1D 38 4C p1 p2 p3 p4 m fn [parameter]  
 Decimal 27 29 56 76 p1 p2 p3 p4 m fn [parameter]

- (\*) Use the ESC GS ( L code to explain each function.  
 - ESC GS ( L and ESC GS 8 L are the same function.  
 - If [parameter] in each function exceeds 65533 bytes, use ESC GS 8 L.

[Function] Runs the process related to the graphics data specified by the function code (fn).

Fn	Code	Function No.	Function
0,48	ESC GS ( L pL pH m fn	48	Send NV graphics memory capacity
3,51	ESC GS ( L pL pH m fn	51	Send remaining NV Graphics memory capacity
64	ESC GS ( L pL pH m fn d1 d2	64	Send NV graphics key code
65	ESC GS ( L pL pH m fn d1 d2 d3	65	Batch all delete NV graphics data
66	ESC GS ( L pL pH m fn kc1 kc2	66	Delete the specified NV graphics data
67	ESC GS ( L pL pH m fn a kc1 kc2 b xL xH yL yH [c d1...dk]1 [c d1...dk]b	67	Define NV graphics data
69	ESC GS ( L pL pH m fn kc1 kc2 x y	69	Print the specified NV graphics data

## <Function 48> ESC GS ( L pL pH m fn (fn=48)

## <Function 48> ESC GS 8 L p1 p2 p3 p4 m fn (fn=48)

[Name] Send NV graphics memory capacity

[Code] ASCII ESC GS ( L pL pH m fn  
 Hexadecimal 1B 1D 28 4C pL pH m fn  
 Decimal 27 29 40 76 pL pH m fn

[Code] ASCII ESC GS 8 L p1 p2 p3 p4 m fn  
 Hexadecimal 1B 1D 38 4C p1 p2 p3 p4 m fn  
 Decimal 27 29 56 76 p1 p2 p3 p4 m fn

[Defined Region] • Parameter for ESC GS ( L  
 (pL+pH×256)=2 (pL=2, pH=0)  
 • Parameter for ESC GS 8 L  
 (p1+p2×256+p3×65536+p4×16777216)=2 (p1=2, p2=0, p3=0, p4=0)  
 • Parameter are shared by for ESC GS ( L and ESC GS 8 L.  
 m = 48,  
 fn = 0, 48

[Function] Sends the entire capacity of NV graphics area in bytes.

[Details] • The byte count is sent in the following format:

Transmission data	Hex	Decimal	Data length
Header	37H	55	1 Byte
Identifier	30H	48	1 Byte
Total capacity *1	30H to 39H	48 to 57	1 to 8 Byte
NUL	00H	0	1 Byte

\*1 The total capacity is the total number of bytes in this region.

The decimal value indicating the total capacity is converted to text data and sent in order from the MSB.

Ex.: When the total capacity is 1200 bytes:

“1200” (Hex:31H, 32H, 30H, 30H, Decimal:49, 50, 48, 48) is converted to 4-bytes of data.

- This command is used when sending total capacity, and the total byte capacity of the region is sent regardless of the current setting for the NV graphics data. This total capacity includes the information region.
- When the value that indicates the entire capacity is “0” (Hex:30H, Decimal:48), it is not possible to use the NV graphics function.

[Note] • Data transmission process: Function 48, 51, 64  
 Observe the following rules when using these functions.

- When the host PC sends this command, the printer sends response data or the status to the PC. The PC does not send any more data until it receives response data or status from the printer.
- When the amount of data exceeds the capacity of the transmission buffer, data is erased.
- Transmission information of each function can be identified as other transmission data by specific data (identifier) of the transmission data string.

When the header sent by the printer is [Hex = 37H/Decimal = 55], data up to NUL  
 [Hex = 00H/Decimal = 0] is handled as one group and identified by corresponding to the combination of the header and identifier.

## <Function 51> ESC GS ( L pL pH m fn (fn=51)

## <Function 51> ESC GS 8 L p1 p2 p3 p4 m fn (fn=51)

[Name] Send NV graphics memory capacity

[Code] ASCII ESC GS ( L pL pH m fn  
 Hexadecimal 1B 1D 28 4C pL pH m fn  
 Decimal 27 29 40 76 pL pH m fn

[Code] ASCII ESC GS 8 L p1 p2 p3 p4 m fn  
 Hexadecimal 1B 1D 38 4C p1 p2 p3 p4 m fn  
 Decimal 27 29 56 76 p1 p2 p3 p4 m fn

[Defined Region]

- Parameter for ESC GS ( L  
 $(pL+pH \times 256)=2$  (pL=2, pH=0)
- Parameter for ESC GS 8 L  
 $(p1+p2 \times 256+p3 \times 65536+p4 \times 16777216)=2$  (p1=2, p2=0, p3=0, p4=0)
- Parameter are shared by for ESC GS ( L and ESC GS 8 L.  
 m = 48,  
 fn = 3, 51

[Function] Sends the remaining capacity (or unused area) of NV graphics area in bytes.

[Details] • Sends the number of bytes in the following format.:

Transmission data	Hex	Decimal	Data length
Header	37H	55	1 Byte
Identifier	31H	49	1 Byte
Total capacity *1	30H to 39H	48 to 57	1 to 8 Byte
NUL	00H	0	1 Byte

\*1 The unused capacity is the total number of bytes of the unused region.

The decimal value indicating the unused capacity is converted to text data and sent in order from the MSB.

Ex.: When the unused capacity is 120 bytes:

“120” (Hex:31H, 32H, 30H, Decimal:49, 50, 48) is converted to 3-bytes of data.

- Information region is also included in the use capacity.
- See the Note for <Function 48> for a detailed explanation of the sending process.

[Reference] ESC GS ( L / ESC GS 8 L <Function 48>

## <Function 64> ESC GS ( L pL pH m fn d1 d2 (fn=64)

## <Function 64> ESC GS 8 L p1 p2 p3 p4 m fn d1 d2 (fn=64)

[Name] Send a key code list of predefined NV graphics

[Code] ASCII ESC GS ( L pL pH m fn d1 d2  
 Hexadecimal 1B 1D 28 4C pL pH m fn d1 d2  
 Decimal 27 29 40 76 pL pH m fn d1 d2

[Code] ASCII ESC GS 8 L p1 p2 p3 p4 m fn d1 d2  
 Hexadecimal 1B 1D 38 4C p1 p2 p3 p4 m fn d1 d2  
 Decimal 27 29 56 76 p1 p2 p3 p4 m fn d1 d2

[Defined Region] • Parameter for ESC GS ( L  
 (pL+pH×256)=4 (pL=4, pH=0)  
 • Parameter for ESC GS 8 L  
 (p1+p2×256+p3×65536+p4×16777216)=4 (p1=4, p2=0, p3=0, p4=0)  
 • Parameter are shared by for ESC GS ( L and ESC GS 8 L.  
 m = 48,  
 fn = 64  
 d1 = 75, d2 = 67

[Function] Sends the defined NV graphics key code list.

[Details] • Sends the key code in the following format:

Transmission data	Hex	Decimal	Data length
Header	37H	55	1 Byte
Identifier	72H	114	1 Byte
Identifier information*1, 2	40H/41H	64/65	1 Byte
Data	20H to 7EH	32 to 126	2 to 80 Byte
NUL	00H	0	1 Byte

\*1 Send one block with identification information (3rd byte) as 40Hex, when the defined NV graphics data count is less than 40.

\*2 Send one block with identification information (3rd byte) as 41Hex, when the defined NV graphics data count is over 40.

• If there is no defined NV graphics key code list, it sends the following format.

Transmission data	Hex	Decimal	Data length
Header	37H	55	1 Byte
Identifier	72H	114	1 Byte
Identifier information	40H	64	1 Byte
NUL	00H	0	1 Byte

• See the Note for <Function 48> for a detailed explanation of the sending process.

[Reference] ESC GS ( L / ESC GS 8 L <Function 48>



## <Function 65> ESC GS ( L pL pH m fn d1 d2 d3 (fn=65)

## <Function 65> ESC GS 8 L p1 p2 p3 p4 m fn d1 d2 d3 (fn=65)

[Name] Erase entire NV graphics data

[Code]	ASCII	ESC	GS	(	L	pL	pH	m	fn	d1	d2	d3
	Hexadecimal	1B	1D	28	4C	pL	pH	m	fn	d1	d2	d3
	Decimal	27	29	40	76	pL	pH	m	fn	d1	d2	d3

[Code]	ASCII	ESC	GS	8	L	p1	p2	p3	p4	m	fn	d1	d2	d3
	Hexadecimal	1B	1D	38	4C	p1	p2	p3	p4	m	fn	d1	d2	d3
	Decimal	27	29	56	76	p1	p2	p3	p4	m	fn	d1	d2	d3

[Defined Region]

- Parameter for ESC GS ( L  
( $pL+pH \times 256$ )=5 (pL=5, pH=0)
- Parameter for ESC GS 8 L  
( $p1+p2 \times 256+p3 \times 65536+p4 \times 16777216$ )=5 (p1=5, p2=0, p3=0, p4=0)
- Parameter are shared by for ESC GS ( L and ESC GS 8 L.  
m = 48,  
fn = 65  
d1 = 67, d2 = 76, d3 = 82

[Function]

Erases all NV graphics data defined by Function 67.

- The erased area is set to be an “unused area.”
- All key codes become undefined.

[Details]

- Effective only at the top of the line in standard mode.
- Data for this parameter is discarded in page mode.
- Do not use this function for macro definition because this function is not compatible with the macros.
- If you use this function, all NV graphics data is erased.  
Take special care if NV graphics data is used in multiple applications.

[Reference] ESC GS ( L / ESC GS 8 L <Function 67>

## <Function 66> GS ( L pL pH m fn kc1 kc2 (fn=66)

## <Function 66> GS 8 L p1 p2 p3 p4 m fn kc1 kc2 (fn=66)

[Name] Erase the specified NV graphics data

[Code]	ASCII	ESC	GS	(	L	pL	pH	m	fn	kc1	kc2
	Hexadecimal	1B	1D	28	4C	pL	pH	m	fn	kc1	kc2
	Decimal	27	29	40	76	pL	pH	m	fn	kc1	kc2

[Code]	ASCII	ESC	GS	8	L	p1	p2	p3	p4	m	fn	kc1	kc2
	Hexadecimal	1B	1D	38	4C	p1	p2	p3	p4	m	fn	kc1	kc2
	Decimal	27	29	56	76	p1	p2	p3	p4	m	fn	kc1	kc2

[Defined Region]

- Parameter for ESC GS ( L  
( $pL+pH \times 256$ )=4 (pL=4, pH=0)
- Parameter for ESC GS 8 L  
( $p1+p2 \times 256+p3 \times 65536+p4 \times 16777216$ )=4 (p1=4, p2=0, p3=0, p4=0)
- Parameter are shared by for ESC GS ( L and ESC GS 8 L.  
m = 48,  
fn = 66  
 $32 \leq kc1 \leq 126$   
 $32 \leq kc2 \leq 126$

[Function]

Erases the NV graphics data defined by key codes kc1 and kc2.

- The erased area is set to be an “unused area.”
- The erased key code becomes undefined.

[Details]

- Effective only at the top of the line in standard mode.
- Data for this counter is discarded in page mode.
- Do not use this function for macro definition because this function is not compatible with the macros.

[Reference] ESC GS ( L / ESC GS 8 L <Function 67>

**<Function 67> ESC GS ( L pL pH m fn a kc1 kc2 b xL xH y L yH [c d1 ... dk] 1 ... [c d1 ... dk] b (fn=67)**

**<Function 67> ESC GS 8 L p1 p2 p3 p4 m fn a kc1 kc2 b xL xH y L yH [c d1 ... dk] 1 ... [c d1 ... dk] b (fn=67)**

[Name]	set the specified NV graphics data													
[Code]	ASCII	ESC	GS	(	L	pL	pH	m	fn	a	kc1	kc2	b	
					xL	xH	yL	yH	[c	d1	...	dk]1	...	[c d1 ... dk]b
	Hexadecimal	1B	1D	28	4C	pL	pH	m	fn	a	kc1	kc2	b	
					xL	xH	yL	yH	[c	d1	...	dk]1	...	[c d1 ... dk]b
	Decimal	27	29	40	76	pL	pH	m	fn	a	kc1	kc2	b	
					xL	xH	yL	yH	[c	d1	...	dk]1	...	[c d1 ... dk]b
[Code]	ASCII	ESC	GS	8	L	p1	p2	p3	p4	m	fn	a	kc1	kc2
					xL	xH	yL	yH	[c	d1	...	dk]1	...	[c d1 ... dk]b
	Hexadecimal	1B	1D	38	4C	p1	p2	p3	p4	m	fn	a	kc1	kc2
					xL	xH	yL	yH	[c	d1	...	dk]1	...	[c d1 ... dk]b
	Decimal	27	29	56	76	p1	p2	p3	p4	m	fn	a	kc1	kc2
					xL	xH	yL	yH	[c	d1	...	dk]1	...	[c d1 ... dk]b

- [Defined Region]
- Parameter for ESC GS ( L  
 $12 \leq (pL+pH \times 256) \leq 65535$  ( $0 \leq pL \leq 255$ ,  $0 \leq pH \leq 255$ )
  - Parameter for ESC GS 8 L  
 $12 \leq (p1+p2 \times 256+p3 \times 65536+p4 \times 16777216) \leq 4294967295$   
 $(0 \leq p1 \leq 255, 0 \leq p2 \leq 255, 0 \leq p3 \leq 255, 0 \leq p4 \leq 255)$
  - Parameter are shared by for ESC GS ( L and ESC GS 8 L.  
 $m = 48, fn = 67, a = 48$   
 $32 \leq kc1 \leq 126$   
 $32 \leq kc2 \leq 126$   
 $b = 1, 2$   
 $1 \leq (xL+xH \times 256) \leq 8192, (0 \leq xL \leq 255, 0 \leq xH \leq 32)$   
 $1 \leq (yL+yH \times 256) \leq 2304, (0 \leq yL \leq 255, 0 \leq yH \leq 9)$   
 $c = 49$  (Single-color),  $c = 49, 50$  (2-color)  
 $0 \leq d \leq 255$   
 $k = \text{int}(((xL + xH \times 256) + 7) \div 8) \times (yL + yH \times 256)$
  - Registration capacity: 512 KByte
  - Maximum registered quantity: 9025 pcs

- [Function]
- Defines the NV graphics data (in raster format) as the record specified by key codes kc1 and kc2.
- “b” specifies a number of colors of the definition data.
  - “xL” and “xH” specify the horizontal size of definition data to “xL + xH x 256” dots.
  - “yL” and “yH” specify the vertical size of definition data to “yL + yH x 256” dots.
  - “c” specifies the definition data color as follows.  
 $c=49$ : Black  
 $c=50$ : Red
  - “d” specifies the definition data (in raster format).
  - If the specified key code already exists in memory, it is overwritten by the specified one.

- [Details]
- NV graphics are image data defined in the non-volatile memory of the printer.  
Data definitions for NV graphics data generated by using this command are valid until redefined by this command.
  - This command is used to define NV graphics data.
  - This function is defined by the raster format.
  - Valid only at the top of the line in standard mode.
  - When page mode is selected, counter data is received and discarded.
  - Do not use this function when defining a macro because it is not compatible with macros.
  - If there is not an adequate amount of space in nonvolatile memory to store the NV graphics data, this function cannot be used.  
Use Function 51 to check the available space that can be used.
  - k byte data  $d_1 \dots d_k$  are processed as one item of the defined NV graphics data.  
Bits that correspond to the dots to print are "1," and the bits that correspond to the dots that are not printed are "0."
  - When single-color ( $b=1$ ) is selected, this is defined as one data group [ $c d_1 \dots d_k$ ].
  - When 2-color ( $b=2$ ) is selected, this is defined as two data groups [ $c d_1 \dots d_k$ ].  
When a color ( $c$ ) is specified, it is important to specify a color different from the data group.  
At that time, the vertical and horizontal sizes of the data are the same.
  - NV graphics data is printed using Function 69.
  - The relationship of NV graphics data (raster format) and printing results are shown below.

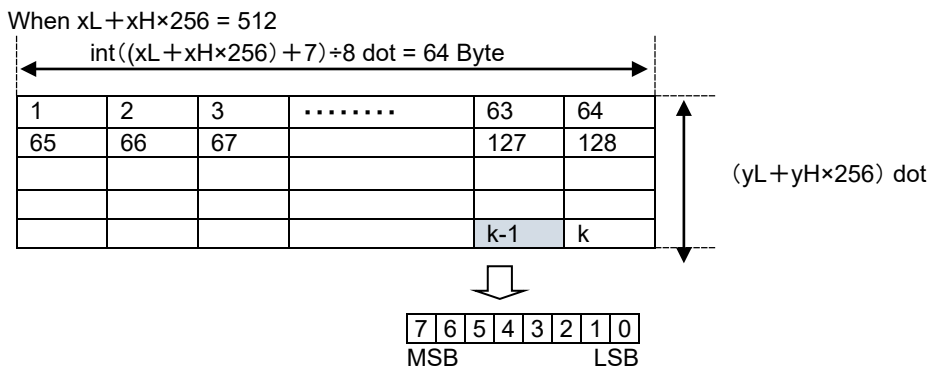

- [Notes]
- When the specification of  $(xL + xH \times 256)$ , and  $(yL + yH \times 256)$  exceed the remaining capacity of the NV graphics region, this function does not operate.
  - This function uses the NV graphics area of "Number of data sets ( $k$ ) + Management data (14 bytes)".

[Model Limitation]

Registration capacity / Maximum registered quantity	
SM-L200 :	512 KByte / 64 pcs
SM-L300 :	512 KByte / 512 pcs
SM-S, T series :	512 KByte / 512 pcs

[Reference] ESC GS ( L / ESC GS 8 L <Function 51>, <Function 69>

## <Function 69> ESC GS ( L pL pH m fn kc1 kc2 x y (fn=69)

## <Function 69> ESC GS 8 L p1 p2 p3 p4 m fn kc1 kc2 x y (fn=69)

[Name] Print the specified NV graphics data

[Code]	ASCII	ESC	GS	(	L	pL	pH	m	fn	kc1	kc2	x	y
	Hexadecimal	1B	1D	28	4C	pL	pH	m	fn	kc1	kc2	x	y
	Decimal	27	29	40	76	pL	pH	m	fn	kc1	kc2	x	y

[Code]	ASCII	ESC	GS	8	L	p1	p2	p3	p4	m	fn	kc1	kc2	x	y
	Hexadecimal	1B	1D	38	4C	p1	p2	p3	p4	m	fn	kc1	kc2	x	y
	Decimal	27	29	56	76	p1	p2	p3	p4	m	fn	kc1	kc2	x	y

[Defined Region]

- Parameter for ESC GS ( L  
(pL+pH×256)=6 (pL=6, pH=0)
- Parameter for ESC GS 8 L  
(p1+p2×256+p3×65536+p4×16777216)=6 (p1=6, p2=0, p3=0, p4=0)
- Parameter are shared by for ESC GS ( L and ESC GS 8 L.  
m = 48  
fn = 69  
32 ≤ kc1 ≤ 126  
32 ≤ kc2 ≤ 126  
x = 1, 2  
y = 1, 2

[Function] Prints the NV graphics data defined by key codes kc1 and kc2.  
• Selected data can be printed in the “horizontal x-times” by “vertical y-times” scale.

[Details]

- This function is used to print the NV graphics data defined by Function 67.
- The printer prints data only when the NV graphics data that matches the specified key code is defined. If data with the specified key code is not found, the data of this counter is discarded.
- This command is effective only when no data exists in the print buffer in standard mode. If any data exists in the print buffer, the data for this counter is discarded.
- Data for this counter is discarded in page mode.
- If graphics that exceeds the print area size is specified, the data within the print area is printed out but the excess data is not printed out.
- The horizontal and vertical size of NV graphics can be specified by “x” and “y”.
- Excluding upside-down printing, print modes (emphasized printing, overlap printing, underlines, character sizes, black/white inverted printing, and 90 degree rotation) are unaffected.
- When normal mode or double-width mode is specified, the paper is fed for the number of dots (the height of NV graphics) and when double-height mode or 4x mode is specified, the paper is fed for the number of dots (NV graphics height multiplied by 2) regardless of the settings of default line spacing (ESC 2) and line feed amount (ESC 3).
- After these graphics are printed, the next printing starts at the beginning of a line (the printer is at the “beginning of the line” and has “no print data”), and subsequent data is processed as normal data.
- This command is affected by the following command settings:
  - Move to absolute position (ESC GS A n1 n2)
  - Move to relative position (ESC GS R n1 n2)
  - Set print area (ESC RS A n)
  - Horizontal tab (HT)
  - Upside-down printing (SI)

[Model Limitation] SM-S and T series: Prints up to 30 cm when the expanded high mode is specified.

[Reference] ESC GS ( L/ESC GS 8 L , ESC GS A , ESC GS R , ESC RS A , HT , SI

## **ESC GS ) L pL pH fn [parameter]**

[Name] Set graphics data  
 [Code] ASCII ESC GS ) L pL pH fn [parameter]  
 Hexadecimal 1B 1D 29 4C pL pH fn [parameter]  
 Decimal 27 29 41 76 pL pH fn [parameter]

[Function] Executes graphics data processing.

- pL and pH specify the parameter count (pL + pH x 256) in bytes after fn.
- See the function specifications for details on [parameter].

Fn	Function No	Function Name
48	Function 48	Send the registered individual logo CRC
49	Function 49	Send the registered individual NV graphics memory capacity
50	Function 50	Send all key code of the registered NV graphics
51	Function 51	Transmit the registered NV graphics data

## <Function 48> ESC GS ) L pL pH fn kc1 kc2

[Name]	Send the registered individual logo CRC									
[Code]	ASCII	ESC	GS	)	L	pL	pH	fn	kc1	kc2
	Hexadecimal	1B	1D	29	4C	pL	pH	fn	kc1	kc2
	Decimal	27	29	41	76	pL	pH	fn	kc1	kc2

[Defined Region] pL = 3, pH = 0  
 fn = 48  
 $32 \leq kc1 \leq 126, 32 \leq kc2 \leq 126$

[Function] Sends a CRC of the logo already stored in the printer.

- [Details]
- The CRC operation is used only for the logo graphics data currently stored in the printer.
  - The key codes, size and color information are excluded from the CRC operation.
  - When the printer receives the command, it calculates the CRC and sends it.
  - If a logo containing multiple colors is stored, the logo data of the “n+1” color is added after the logo data of the “n-th” color and calculated.
  - The CRC operation is as follows.

CRC16: Polynomial =  $x^{16}+x^{15}+x^2+x^0$   
 Initial value: FFFF (Hex)  
 Shift direction: Right  
 Output XOR: FFFF (Hex)

\* See the sample codes for concrete implementation examples.

- The CRC of only the stored logo can be sent by the “ESC GS ( L” or “ESC GS 8 L” command.
- When logo data is stored, the CRC of the received data is operated.
- If the logo data exceeds the horizontal print area, the CRC is operated based on the data that is received when logo data is stored.

The CRC is sent in the following format:

ESC GS ) L pL pH fn kc1 kc2 [CRC-data] LF NUL

Note) The CRC data is converted into a character string and sent.

Ex.: When [CRC data] is fixed at 4 bytes and CRC is 01AB (HEX), this is “01AB” (Hex: 30H, 31H, 41H, 42H; Decimal: 48, 49, 65, 66) 4-byte data.

If a unregistered key code is specified, the following data is sent instead:

ESC GS ) L pL pH fn kc1 kc2 LF NUL

### <Command processing flow>

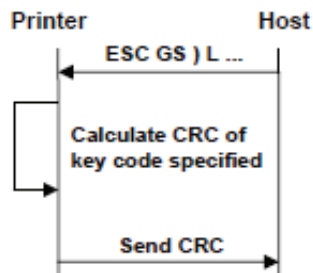

<CRC calculation procedure, sample codes, C language>

```
#define CRC16 0xA001

unsigned int CalcCrc16( int size, unsigned char data[] )
{
    unsigned int result;
    int i,j;

    result = 0xFFFF;

    for( i=0 ; i<size; i++)
    {
        result ^= data[i];
        for(j = 0x0001; j < 0x0100; j = j << 1)
        {
            if( result & 0x0001 )
            {
                result >>= 1;
                result ^= CRC16;
            }
            else
            {
                result >>= 1;
            }
        }
    }
    result = (~result) & 0xFFFF;
    return result;
}
```

[Reference] ESC GS ( L, ESC GS 8 L



## <Function 49> ESC GS ) L pL pH fn kc1 kc2

[Name]	Transmit capacity used by registered individual NV graphics									
[Code]	ASCII	ESC	GS	)	L	pL	pH	fn	kc1	kc2
	Hexadecimal	1B	1D	29	4C	pL	pH	fn	kc1	kc2
	Decimal	27	29	41	76	pL	pH	fn	kc1	kc2

[Defined range]      pL = 3, pH = 0  
                           fn = 49  
                            $32 \leq kc1 \leq 126, 32 \leq kc2 \leq 126$

[Function]            Transmits the capacity used by the individual NV graphics data registered in the printer.

[Detail]              • The used capacity is the total number of bytes of the used area.  
                           • The used capacity includes the management data (14 bytes).  
                           • Only the capacity used by NV graphics data registered with the "ESC GS ( L" or "ESC GS 8 L" command can be transmitted.

The used capacity is transmitted in the following format:

ESC GS ) L pL pH fn kc1 kc2 [used capacity] LF NUL

Example: When the used capacity is 1200 bytes, [used capacity] will be

"1200" converted into four-byte data (Hex 31h, 32h, 30h, 30h; Decimal: 49, 50, 48, 48).

If an unregistered key code is specified, the following data is transmitted instead:

ESC GS ) L pL pH fn kc1 kc2 LF NUL

[Reference]          ESC GS ( L , ESC GS 8 L

## <Function 50> ESC GS ) L p L p H f n d 1 d 2

[Name]	Send all key code of the registered NV graphics									
[Code]	ASCII	ESC	GS	)	L	pL	pH	fn	d1	d2
	Hexadecimal	1B	1D	29	4C	pL	pH	fn	d1	d2
	Decimal	27	29	41	76	pL	pH	fn	d1	d1

[Defined Region]    pL = 3, pH = 0  
                           fn = 50  
                           d1 = 0, d2 = 0

[Function]            Send all key code of NV graphics already stored in the printer.

[Details]             - If NV graphics are registered with "ESC GS ( L" or "ESC GS 8 L" command, all of their key codes can be sent.

All key codes are sent in the following format.

ESC GS) L pL pH fn k1 k2 [key-code key-code ...] LF NUL

Up to 512 key codes can be sent, but logo key codes exceeding this limit are not sent.

k1 and k2 represent the number of transmission data bytes ( $k1+k2 \times 256$ ) after the key codes.

Example: If NV graphics of key codes 01 and 02 are registered, k1=6 and k2=0. [key-code key-code...] is "0102" (30h, 31h, 30h, 32h in Hex; and 48, 49, 48, 50 in Decimal).

If NV graphics are not registered, the following data is sent.

ESC GS ) L pL pH fn k1 k2 LF NUL (where, k1=2 and k2=0)

If the USB interface is used, the NSB must be made invalid.

[Reference]          ESC GS ( L , ESC GS 8 L

## <Function 51> ESC GS ) L pL pH fn kc1 kc2

[Name] Transmit the registered individual NV graphics data

[Code]	ASCII	ESC	GS	)	L	pL	pH	fn	kc1	kc2
	Hexadecimal	1B	1D	29	4C	pL	pH	fn	kc1	kc2
	Decimal	27	29	41	76	pL	pH	fn	kc1	kc2

[Defined Region] pL = 3, pH = 0  
 fn = 51  
 $32 \leq kc1 \leq 126$ ,  $32 \leq kc2 \leq 126$

[Function] Transmit the individual NV graphics data registered in the printer.

[Details] • NV graphics data registered by ESC GS ( L or ESC GS 8 L <Function 67> is transmitted.  
 • Specified key codes kc1 and kc2 are acquired by the following transmit command: all key code of the registered NV graphics.

The registered data is transmitted in the format below.  
 ESC GS ) L pL pH fn kc1 kc2 b xL xH yL yH [c d1 ... dk]1 ... [c d1 ... dk]b LF NUL

Data below shall become as the parameter defined by the NV graphics data definition command corresponding to the specified key codes kc1 and kc2.

- "b" specifies the number of colors in definition data. b = 1, 2
- "xL" and "xH" specifies the horizontal direction size (xL + xH × 256) dot counts in definition data.
- "yL" and "yH" specifies the vertical direction size (yL + yH × 256) dot counts in definition data.
- "c" specifies the color information in definition data. c = 49: Black; c = 50: Red
- "d" specifies the definition data (in raster format).

If a unregistered key code is specified, the following data is transmitted instead:  
 ESC GS ) L pL pH fn kc1 kc2 LF NUL

[Reference] ESC GS ( L / ESC GS 8 L <Function 67>

**2.3.14. Bar Code**
**ESC b n1 n2 n3 n4 d1...dk RS**

[Name]	Barcode Printing										
[Code]	ASCII	ESC	b	n1	n2	n3	n4	d1	...	dk	RS
	Hex.	1B	62	n1	n2	n3	n4	d1	...	dk	1E
	Decimal	27	98	n1	n2	n3	n4	d1	...	dk	30

[Defined Area]  $0 \leq n1 \leq 13$ ,  $48 \leq n1 \leq 57$  ("0"  $\leq n \leq$  "9"),  $65 \leq n1 \leq 68$  ("A"  $\leq n \leq$  "D")  
 n2 (Under-bar character selection), n3 (bar code mode) d (bar code data), k (bar code data count)  
 definitions differ according to the type of bar code.  
 $1 \leq n2 \leq 14$ ,  $48 \leq n2 \leq 57$  ("0"  $\leq n \leq$  "9"),  $65 \leq n2 \leq 69$  ("A"  $\leq n \leq$  "E")  
 $1 \leq n4 \leq 255$

[Initial Value] - - -

[Function] Bar code printing is executed according to the following parameters.  
 If n1, n2, n3 and n4 are acquired and detected to be out of the defined area, data up to RS is discarded.

## • n1 bar code type selection

n1	Bar code type
0, 48	UPC-E
1, 49	UPC-A
2, 50	JAN/EAN8
3, 51	JAN/EAN13
4, 52	Code39
5, 53	ITF
6, 54	Code128
7, 55	Code93
8, 56	NW-7
9, 57	GS1-128
10, 65	GS1 DataBar Omnidirectional
11, 66	GS1 DataBar Truncated
12, 67	GS1 DataBar Limited
13, 68	GS1 DataBar Expanded

## • n2 Under-bar character selection and added line feed selection

n2	Under-bar character type					
	UPC-E, UPC-A, JAN/EAN8, JAN/EAN13, Code128, Code93, Code39, NW-7, ITF			GS1-128, GS1 DataBar		
	Font	Position of under-bar character	line feed after printing	Font	Position of under-bar character	line feed after printing
1, 49	- - -	None	Execute	- - -	None	Execute
2, 50	Font A	Under position	Execute	Font A	Under position	Execute
3, 51	- - -	-	not execute	- - -	None	not execute
4, 52	Font A	Under position	not execute	Font A	Under position	not execute
5, 53	- - -	- - -	- - -	Font A	Upper	Execute
6, 54	- - -	- - -	- - -	Font A	Upper	not execute
7, 55	- - -	- - -	- - -	Font A	Upper, Under	Execute
8, 56	- - -	- - -	- - -	Font A	Upper, Under	not execute
9, 57	- - -	- - -	- - -	Font B	Under	Execute
10, 65	- - -	- - -	- - -	Font B	Under	not execute
11, 66	- - -	- - -	- - -	Font B	Upper	Execute
12, 67	- - -	- - -	- - -	Font B	Upper	not execute
13, 68	- - -	- - -	- - -	Font B	Upper, Under	Execute
14, 69	- - -	- - -	- - -	Font B	Upper, Under	not execute

## • n3 bar code mode selection Spec. 1

n3	Bar code type			
	UPC-E, UPC-A, JAN/EAN8 JAN/EAN13, Code128, Code93	Code39, NW-7	ITF	GS1-128, GS1 DataBar
	Minimum module	Narrow : Wide	Narrow : Wide	Minimum module
1, 49	2 dots	2 : 6 dots	2 : 5 dots	1 dots
2, 50	3 dots	3 : 9 dots	4 : 10 dots	2 dots
3, 51	4 dots	4 : 12 dots	6 : 15 dots	3 dots
4, 52	---	2 : 5 dots	2 : 4 dots	4 dots
5, 53	---	3 : 8 dots	4 : 8 dots	5 dots
6, 54	---	4 : 10 dots	6 : 12 dots	6 dots
7, 55	---	2 : 4 dots	2 : 6 dots	---
8, 56	---	3 : 6 dots	3 : 9 dots	---
9, 57	---	4 : 8 dots	4 : 12 dots	---

## • n3 bar code mode selection Spec. 3

n3	Bar code type				
	Code128	UPC-E, UPC-A, JAN/EAN8, JAN/EAN13, Code93	Code39, NW-7	ITF	GS1-128, GS1 DataBar
	Minimum module	Minimum module	Narrow : Wide	Narrow : Wide	Minimum module
0, 48	1 dot	---	---	---	---
1, 49	2 dots	2 dots	2 : 6 dots	2 : 5 dots	1 dot
2, 50	3 dots	3 dots	3 : 9 dots	4 : 10 dots	2 dots
3, 51	4 dots	4 dots	4 : 12 dots	6 : 15 dots	3 dots
4, 52	---	---	2 : 5 dots	2 : 4 dots	4 dots
5, 53	---	---	3 : 8 dots	4 : 8 dots	5 dots
6, 54	---	---	4 : 10 dots	6 : 12 dots	6 dots
7, 55	---	---	2 : 4 dots	2 : 6 dots	---
8, 56	---	---	3 : 6 dots	3 : 9 dots	---
9, 57	---	---	4 : 8 dots	4 : 12 dots	---

[Note] The bar codes that are printed do not conform to each standard, so you should confirm before actual use. Particularly, if 1dot is specified, the bar code is not guaranteed.

- n4 bar code height (dot count)  
Form feed at (Bar code height + underbar characters)
- k (Bar code data count), d (Bar code data)

Bar code type	Defined area of k	Defined area of d
UPC-E	$11 \leq k \leq 12$	$48 \leq d \leq 57$ ("0" $\leq d \leq$ "9")
UPC-A	$11 \leq k \leq 12$	$48 \leq d \leq 57$ ("0" $\leq d \leq$ "9")
JAN/EAN8	$7 \leq k \leq 8$	$48 \leq d \leq 57$ ("0" $\leq d \leq$ "9")
JAN/EAN13	$12 \leq k \leq 13$	$48 \leq d \leq 57$ ("0" $\leq d \leq$ "9")
Code39	$1 \leq k$	$48 \leq d \leq 57$ ("0" $\leq d \leq$ "9") $65 \leq d \leq 90$ ("A" $\leq d \leq$ "Z") 32, 36, 37, 43, 45, 46, 47 (SP, "\$", "%", "+", "-", ".", "/")
ITF	$1 \leq k$ When an odd number: 0 is automatically applied to the top.	$48 \leq d \leq 57$ ("0" $\leq d \leq$ "9")
Code128	$1 \leq k$	$0 \leq d \leq 127$
Code93	$1 \leq k$	$0 \leq d \leq 127$
NW-7	$1 \leq k$	$48 \leq d \leq 57$ ("0" $\leq d \leq$ "9") $65 \leq d \leq 68$ ("A" $\leq d \leq$ "D") 36, 43, 45, 46, 47, 58 ("\$", "+", "-", ".", "/", ":") 97, 98, 99, 100 ("a", "b", "c", "d")
GS1-128	$2 \leq k \leq 255$	$0 \leq d \leq 127$
GS1 DataBar Omnidirectional	$k = 13$	$48 \leq d \leq 57$
GS1 DataBar Truncated	$k = 13$	$48 \leq d \leq 57$
GS1 DataBar Limited	$k = 13$	$48 \leq d \leq 57$ [However, $48 \leq d1 \leq 49$ ]
GS1 DataBar Expanded	$2 \leq k \leq 255$	$32 \leq d \leq 34$ , $37 \leq d \leq 63$ , $65 \leq d \leq 90$ , $d = 95$ , $97 \leq d \leq 122$ , $d = 123$ [However, $d1 = 40$ , $48 \leq d2 \leq 57$ , $48 \leq d3 \leq 57$ , or $48 \leq d1 \leq 57$ , $48 \leq d2 \leq 57$ ]

- UPC – E: k = 11 (or 12)
  - The 12<sup>th</sup> check digit is automatically applied, so it is specified and ignored.
  - The command is ignored for data that cannot be shortened.
  - Automatically converts data to shortened form.
- UPC – A: k = 11 (or 12)
  - The 12th check digit is automatically applied, so it is specified and ignored.
- JAN/EAN – 8: k = 7 (or 8)
  - The 8th check digit is automatically applied, so it is specified and ignored.
- JAN/EAN -13: k = 12 (or 13)
  - The 13th check digit cannot be automatically applied, so it is specified and ignored.
- CODE 39: k is freely set, and maximum value differs according to the mode.
  - Start/stop code (“\*”) is automatically applied.
- ITF: k is freely set, and maximum value differs according to the mode.
  - If data is oddly numbered, a 0 is applied to the top.
- CODE 128: k is freely set, and maximum value differs according to the mode and the print character type.
  - The check character is automatically applied.
- CODE 93: k is freely set, and maximum value differs according to the mode and the print character type.
  - The check character (“□”) is automatically applied.
- NW7: k is freely set, and maximum value differs according to the mode and the print character type.
  - Start/stop codes included in the data (not automatically applied).
- GS1DataBar Omnidirectional, Truncated, Limited: k = 13
  - The 14th check digit is automatically applied
- GS1DataBar Expanded: k is freely set, and maximum value differs according to the mode and the print character type.
- GS1-128: k is freely set, and maximum value differs according to the mode and the print character type.

### 2.3.15. Two-Dimensional Bar Code QR Code Command Details

Note) QR code is a registered trademark of DENSO WEB.

This command is for printing 2-dimensional bar code QR codes. There are four functions of the commands relating to the 2-dimensional bar code QR codes, shown below.

- |                       |                      |
|-----------------------|----------------------|
| (1) Set bar code type | (<ESC> <GS> "y" "S") |
| (2) Set bar code data | (<ESC> <GS> "y" "D") |
| (3) Set page mode     | (Reserved)           |
| (4) Print Bar code    | (<ESC> <GS> "y" "P") |

The details of each function are described below.

#### (1) Set bar code type

These commands set the bar code type. Because all initial values are set, use these only to make changes. (See the details for each setting below.)

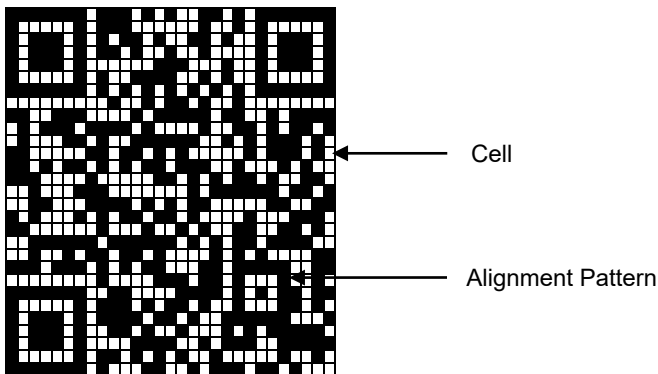

<ESC> <GS> "y" "S" "0" Sets the model

Currently supported models are model 1 and model 2. Model 2 has a configuration including an alignment bar to improve its support of weight to handle skewing when codes are large.

<ESC> <GS> "y" "S" "1" Sets the error correction level

QR codes can be read even if a part of the data is corrupted, by using error correction. Raising this level increases the size of the bar code because there is an increase in preparatory information.

<ESC> <GS> "y" "S" "2" Specifies the size of the cell (One four squared region configuring the QR code)

The QR code is formed into a square of an equivalent size in the vertical and horizontal directions, but the size of the bar code image that is generated depends on the cell size setting. See [Appendix 4](#) for details on the actual printed size of the QR code.

These settings are individual settings. Therefore, even though there may not be any particular problem in each of them, there is the potential for an error to be generated. (See the descriptions below.) In such cases, the bar code will not be generated and the (4) Print command (<ESC> <GS> "y" "P") is ignored.

- Error is generated when generating a bar code by the combination of each setting command.
- Print data exceeds the currently set print region

### (2) Set bar code data

This command sets the bar code print data. There are four types of data that can be set using QR codes. They are: numbers; English characters; binary; and Kanji. Furthermore, there are two types of data setting methods. One is to specify these along with the bar code data (data manual analysis), and the other is to specify only the bar code data (data automatic analysis).

### (3) Set page mode

This command is not used.

### (4) Print Bar code

This command prints bar codes based on the settings of (1) to (3).

= Precautions on using these commands =

- The setting values for (1) to (3) are held unless any of the following operations are performed.
  - Sending a new setting command
  - Sending an initialize command (<ESC> @)
  - Turning the power OFF
- When there is an error in sending a command with (2), the set data is cleared and the command itself is disabled.
- (4) is sent when necessary.
- Printing:
  - When printing, position movement using specify absolute position, specify relative position, and align position are enabled.
  - Upside down printing and 2-color printing are possible.
- Printed bar codes should always be checked in an actual use.

The following is an example showing the sending of the commands.

#### (1) Set bar code type

- <ESC> <GS> "y" "S" "0" 1 : Sets to model 1.
- <ESC> <GS> "y" "S" "1" 0 : Sets mistake correction level to L.
- <ESC> <GS> "y" "S" "2" 3 : Sets cell size to 3 dots.

#### (2) Set bar code data

- <ESC> <GS> "y" "D" "1" 0 19 0 "2005, January, 1 (SAT)"  
Sets bar code data (Data automatic analysis)  
Sets bar code data (Data manual analysis)
- <ESC> <GS> "y" "D" "2" 9 1 4 0 "2005" " ,"  
4 2 0 "Year" " ,"  
1 1 0 "1" " ,"  
4 2 0 "Month" " ,"  
1 1 0 "1" " ,"  
4 2 0 "Day" " ,"  
4 2 0 "(" " ,"  
2 3 0 "SAT" " ,"  
4 2 0 ")" " ,"  
3 1 0 <LF>

#### (3) Print bar code

- <ESC> <GS> "y" "p" : Print



### **ESC GS y S 0 n**

[Name] Set QR code model  
 [Code] ASCII ESC GS y S 0 n  
 Hex. 1B 1D 79 53 30 n  
 Decimal 27 29 121 83 48 n

[Defined Area] Spec. 1  $1 \leq n \leq 2$   
 Spec. 2  $n = 2$

[Initial Value]  $n = 2$

[Function] Sets the model.

• Parameter details

n	Model settings
1	Model 1
2	Model 2

### **ESC GS y S 1 n**

[Name] Set QR code mistake correction level  
 [Code] ASCII ESC GS y S 1 n  
 Hex. 1B 1D 79 53 31 n  
 Decimal 27 29 121 83 49 n

[Defined Area]  $0 \leq n \leq 3$

[Initial Value]  $n = 0$

[Function] Sets the mistake correction level.

• Parameter details

n	Mistake Correction Level	Mistake Correction Rate (%)
0	L	7
1	M	15
2	Q	25
3	H	30

### **ESC GS y S 2 n**

[Name] Set QR code cell size  
 [Code] ASCII ESC GS y S 2 n  
 Hex. 1B 1D 79 53 32 n  
 Decimal 27 29 121 83 50 n

[Defined Area]  $1 \leq n \leq 8$

[Initial Value]  $n = 3$

[Function] Sets the cell size.

• Parameter details

• n: Cell size (Units: Dots)

• It is recommended that the specification using this command be  $3 \leq n$ .

If  $n = 1$  or  $2$ , check by actually using.

## **ESC GS y D 1 m nL nH d1 d2 ... dk**

[Name] Set QR code cell size (Auto Setting)

[Code]	ASCII	ESC	GS	y	D	1	m	nL	nH	d1	d2	...	dk
	Hex.	1B	1D	79	44	31	m	nL	nH	d1	d2	...	dk
	Decimal	27	29	121	68	49	m	nL	nH	d1	d2	...	dk

[Defined Area] m = 0

$0 \leq nL \leq 255, 0 \leq nH \leq 255$

$1 \leq nL + nH \times 256 \leq 7089$  (k = nL + nH x 256)

$0 \leq d \leq 255$

[Initial Value] - - -

[Function] Automatically expands the data type of the bar code and sets the data.

- Parameter details
- nL + nH x 256: Byte count of bar code data
- dk: Bar code data (Max. 7089 bytes)
- When using this command, the printer receives data for the number of bytes (k) specified by nL and nH.  
The data automatically expands to be set as the bar code data.
- Indicates the number bytes of data specified by the nL and nH.  
Bar code data is cleared at this time.
- The data storage region of this command is shared with the manual setting command so data is update  
d each time either command is executed.

[Model Limitations] SM-L200 : Not supported with versions 10 to 40.

## ESC GS y D 2 a m1 n1L n1H d11 d12 ... d1k m2 n2L n2H d21 d22 ... d2k ml ...

### dlk

[Name] Set QR code cell size (Manual setting)

[Code]	ASCII	ESC	GS	y	D	2	a	m1	n1L	n1H	d11	d12	...	d1K
	Hex.	1B	1D	79	44	32	a	m1	n1L	n1H	d11	d12	...	d1K
	Decimal	27	29	121	68	50	a	m1	n1L	n1H	d11	d12	...	d1K
	ASCII	m2	n2L	n2H	d21	d22	...	d2K	ml	...	dkl			
	Hex.	m2	n2L	n2H	d21	d22	...	d2K	ml	...	dkl			
	Decimal	m2	n2L	n2H	d21	d22	...	d2K	ml	...	dkl			

[Defined Area]

- $1 \leq a \leq 255$
- $1 \leq m \leq 4$
- $0 \leq nL \leq 255, 0 \leq nH \leq 255$
- $1 \leq nL + nH \times 256 \leq 7089$  ( $k = nL + nH \times 256$ )
- $0 \leq d \leq 255$
- $1 \leq l \leq 255$

[Initial Value] - - -

[Function] Specifies the bar code data type and sets the data.

• Parameter details

- a: Block count
- m: Input data type
- nL + nH x 256: Bar code data byte count
- dk: Bar code data (Max. 7089 bytes)

m	Data Type	Data Definition Region (d)
1	Numbers	"0" to "9"
2	English Characters	“, “\$”, “%”, “*”, “+”, “-”, “.”, “/”, “:”, “0” to “9”, “A” to “Z”, “a” to “z”
3	Binary	0x00 to 0xFF
4	Kanji (Shift JIS)	0x8140 to 0x9FFC, 0xE040 to 0xEBBF However, the lower 8 bits are 0x40 to 0x7E, and 0x80 to 0xFC

- The printer receives the data type specified by m, and the data of the number of bytes (k) specified by nL and nH, based on the block count specified by a.
- 1 block specified by a indicates m1, n1L, n1H, d11 ... d1k (data type + data count + bar code data), and by continuously sending these a multiple of times, one bar code data can mix data types.
- It is possible to set a maximum of 255 blocks with one command transmission.
- nL and nH specify the number of bytes of the data, so when using Kanji, calculate that 1 character has 2 bytes.
- If this command is outside of the definition region, immediately stop the command analysis process. When doing so, the bar code data is cleared.
- This command data storage region is shared with the automatic setting command, so data is updated each time either command is executed.
- When data type is set to alphanumeric (m=2) and data of alphabet characters "a" to "z" is sent, they are converted into uppercase alphabet characters "A" to "Z" and their barcode data is generated.

[Model Limitations] SM-L200 : Not supported with versions 10 to 40.

## ESC GS y P

[Name]	Print QR code				
[Code]	ASCII	ESC	GS	y	P
	Hex.	1B	1D	79	50
	Decimal	27	29	121	80

[Defined Area] ---

[Initial Value] ---

[Function] Prints bar code data.

When receiving this command, if there is unprinted data in the image buffer, the printer will print the bar code after printing the unprinted print data.

A margin of more than 4 cells is required around the QR code. The user should ensure that space.

Always check printed bar codes in actual use.

### 2.3.16. Two-Dimensional Bar Code PDF417 Command Details

This command prints two-dimensional bar code PDF417.

There are four types of commands, according to functions, for two-dimensional bar code PDF417.

- (1) Bar code type setting      (<ESC> <GS> "x" "S")
- (2) Bar code data setting      (<ESC> <GS> "x" "D")
- (3) Bar code printing          (<ESC> <GS> "x" "P")

The following describes the functions in detail.

#### (1) Bar code type setting

These commands set the bar code type. Because these are all set with default values, they should be used only when it is necessary to change. (Refer to section below for details on each setting.)

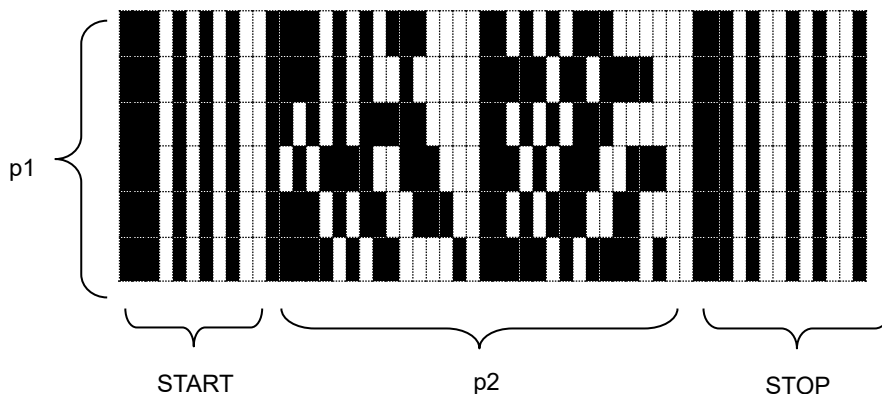

PDF417 is configured by a fixed bar pattern for starting and stopping, and a bar pattern called a code word. Code words are configured by 17 modules.

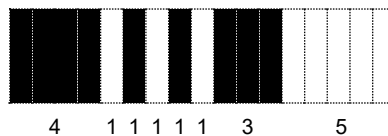

Code Word

<ESC> <GS> "x" "S" "0" specifies values of p1 and p2.

USE\_LIMITS mode specify the ratio of p1 and p2. USE\_FIXED mode specifies p1 (line count) and p2 (code word count per line).

<ESC> <GS> "x" "S" "1" specifies values of error correction levels.

PDF417 can read information even if a portion of the data is corrupted by using the error correction.

By increasing this level, the bar code size increases because there is more preparatory information.

<ESC> <GS> "x" "S" "2" and <ESC> <GS> "x" "S" "3" specify the size of the module that configures the code word.

The X direction size (in dot increments) is determined by <ESC> <GS> "x" "S" "2" for the module, and <ESC> <GS> "x" "S" "3" specifies the Y direction size from the aspect.

Module size setting is the basis for the bar code image that is generated, so the resulting print will vary according to that setting.

The settings above are set individually, so the errors described below may be generated even if there is no particular problem in those settings. In such case, if the bar code is generated the (3) print command (<ESC> <GS> "x" "P") is ignored.

- Error is generated when generating a bar code, due to the combination of the bar code setting commands.
- The bar code data that is generated exceeds the printable size of PDF417.
- Print data exceeds the currently set print region.

### (2) Bar code data setting command

This command sets the print data of the bar code.

### (3) Bar code print command

This command prints the bar code according to the settings of (1) and (2).

= Precautions for use of commands =

- Unless the following operations are performed, the setting values are maintained for (1) and (2).
  - Sending of new setting commands
  - Sending an initializing command (<ESC> @)
  - The power is turned off
- Sending (3) when needed
- Printing
  - When printing, position shifting according to the horizontal tab, absolute position specification, relative position specification, and position alignment is valid.
  - Upside-down printing and two-color printing are possible.
- When a bar code is printed, always verify it by actual use.

Send the command transmission example last.

#### 1. Bar code type setting

<ESC> <GS> "x" "S" "0" 0 2 3 :      Sets the bar code size to USE\_LIMITS = 2:3  
 <ESC> <GS> "x" "S" "1" 3 :      Sets ECC level to 3  
 <ESC> <GS> "x" "S" "2" 3 :      Sets the module X direction size to 3 dots  
 <ESC> <GS> "x" "S" "3" 3 :      Sets module aspect ratio to 3

#### 2. Bar code data setting

<ESC> <GS> "x" "D" 10 0 "0123456789":      Sets the bar code data

#### 3. Printing bar code

<ESC> <GS> "x" "P" :      Print

## ESC GS x S 0 n p1 p2

[Name] Set PDF417 bar code size  
 [Code] ASCII ESC GS x S 0 n p1 p2  
 Hex. 1B 1D 78 53 30 n p1 p2  
 Decimal 27 29 120 83 48 n p1 p2

[Defined Area] n = 0, 1  
 When n = 0:  $1 \leq p1 \leq 99, 1 \leq p2 \leq 99$   
 When n = 1:  $p1 = 0$  or  $3 \leq p1 \leq 90, p2 = 0$  or  $1 \leq p2 \leq 30$  (However, this excludes  $p1 = p2 = 0$ )  
 [Initial Value] n = 0, p1 = 1, p2 = 2  
 [Function] Parameter details

n (Specify Method to Specify Bar Code Size)		p1, p2 (Size Specification)
0	USE_LIMITS (Specify ratio of bar code horizontally and vertically)	p1: p2: Proportions of Vertical (p1) and Horizontal (p2) However, $p1: p2 = 1: 99$ to $10: 1$ ( $p1/p2 = 0.01$ to $10$ )
1	USE_FIXED (Specifies number of lines and number of columns of bar code.)	p1: Number of lines (0, 3 to 90), p2: Number of columns (0, 1 to 30). However, $p1 * p2 \leq 928$ When either p1 or p2 specifies 0, it indicates that that setting value is variable.

Setting the bar code size using this command specifies the general size of the bar code.  
 The size will automatically be corrected according to the other settings.

## ESC GS x S 1 n

[Name] Set PDF417 ECC (security level)  
 [Code] ASCII ESC GS x S 1 n  
 Hex. 1B 1D 78 53 31 n  
 Decimal 27 29 120 83 49 n

[Defined Area]  $0 \leq n \leq 8$   
 [Initial Value] n = 1  
 [Function] Parameter details  
 • n: ECC level (0 to 8)

## ESC GS x S 2 n

[Name] Set PDF417 module X direction size  
 [Code] ASCII ESC GS x S 2 n  
 Hex. 1B 1D 78 53 32 n  
 Decimal 27 29 120 83 50 n

[Defined Area]  $1 \leq n \leq 10$   
 [Initial Value] n = 2  
 [Function] Parameter details  
 • n: Sets the module X direction size (x-dim). Units: Dots  
 It is recommended that  $2 \leq n$  when specifying using this command.  
 When using with n = 1, check by actual use.

### ESC GS x S 3 n

[Name]	Set PDF417 module aspect ratio						
[Code]	ASCII	ESC	GS	x	S	3	n
	Hex.	1B	1D	78	53	33	n
	Decimal	27	29	120	83	51	n

[Defined Area]  $1 \leq n \leq 10$

[Initial Value]  $n = 3$

[Function] Parameter details

- n: Sets the module aspect ratio (asp).

The module Y direction size (x-dim x asp) is set using this command.

It is recommended that  $2 \leq n$  when specifying using this command.

When using with  $n = 1$ , check by actual use.

### ESC GS x D nL nH d1 d2 ... dk

[Name]	Set PDF417 bar code data										
[Code]	ASCII	ESC	GS	x	D	nL	nH	d1	d2	...	dk
	Hex.	1B	1D	78	44	nL	nH	d1	d2	...	dk
	Decimal	27	29	120	68	nL	nH	d1	d2	...	dk

[Defined Area]  $0 \leq nL \leq 255, 0 \leq nH \leq 255$

$1 \leq (nL + nH \times 256) \leq 1024$

$0 \leq d \leq 255$

$1 \leq k \leq 1024$

[Initial Value] - - -

[Function] Parameter details

- $nL + nH \times 256$  : Bar code data count
- $d1...dk$  : Bar code data (Maximum 1024 data)

When  $[nL + nH \times 256]$  is outside of the definition, data of  $[nL + nH \times 256]$  bytes is discarded.

[Model Limitations] SM-L200: Maximum settable barcode data count 128 byte

$1 \leq (nL + nH \times 256) \leq 128, 1 \leq k \leq 128$

### ESC GS x P

[Name]	Print PDF417 bar code				
[Code]	ASCII	ESC	GS	x	P
	Hex.	1B	1D	78	50
	Decimal	27	29	120	80

[Defined Area] - - -

[Initial Value] - - -

[Function] Prints the bar code data.

If there is unprinted data in the line buffer, this command is executed after printing that data in the line buffer. Therefore, it is not possible to print with other data in the same line (characters, bit images, bar codes).

Also, this command is ignored if the following errors occur.

- When an error is generated when generating a bar code, due to the combination of the bar code setting

commands

- When the bar code data that is generated exceeds the printable size of PDF417

- When the print data exceeds the currently set print region

When a bar code is printed, always verify it by actual use.



### 2.3.17. GS1 2D Code, Compound symbol Command Details

#### **ESC GS ( k pL pH cn fn [parameter]**

[Name]	Set and print symbol									
[Code]	ASCII	ESC	GS	(	k	pL	pH	cn	fn	n
	Hex.	1B	1D	28	6B	pL	pH	cn	fn	n
	Decimal	27	29	40	107	pL	pH	cn	fn	n

- [Function]           Runs processes related to symbol.
- pL and pH specify the parameter count (pL + pH x 256) in bytes after cn.
  - Specifies the type of symbol with cn.
  - Specifies the function with fn.
  - See the function specifications for details on [parameter].

cn	Type of Symbol
51	2D GS1 DataBar (GS1 DataBar Stacked, GS1 DataBar Stacked Omnidirectional, GS1 DataBar Expanded Stacked)
52	GS1 compound symbol (2-dimensional code)

cn	fn	Function No.	Function Name
51	67	Function 367	2D GS1 DataBar: Set module size
	71	Function 371	2D GS1 DataBar: Set The maximum width of the 2D GS1DataBar Expanded Stacked
	80	Function 380	2D GS1 DataBar: Store data in symbol saving region
	81	Function 381	2D GS1 DataBar: Print symbol data of symbol saving region
52	67	Function 467	Compound symbol: Set module size
	71	Function 471	Compound symbol: Set The maximum width of the 2D GS1DataBar Expanded Stacked
	72	Function 472	Compound symbol: Set HRI Font
	80	Function 480	Compound symbol: Store data in symbol saving region
	81	Function 481	Compound symbol: Print symbol data of symbol saving region

### **<Function 367> ESC GS ( k pL pH cn fn n (cn=51, fn=67)**

[Name]	2D GS1 DataBar: Set module siz									
[Code]	ASCII	ESC	GS	(	k	pL	pH	cn	fn	n
	Hex.	1B	1D	28	6B	pL	pH	cn	fn	n
	Decimal	27	29	40	107	pL	pH	cn	fn	n
[Defined Area]	pL = 3, pH = 0 cn = 51 fn = 67 $2 \leq n \leq 8$									
[Initial Value]	n = 2									
[Function]	Sets 2D GS1 DataBar module width to n dots.									
[Details]	The setting of this function affects processes of Functions 081 and 082. This setting is valid until ESC @ is executed, the printer is reset or the power is turned off. Set in units of 1 dot. The width is set in 0.125 mm (1/203 inches) units.									
[Reference]	ESC GS ( k Function 381, ESC @									

### **<Function 371> ESC GS ( k pL pH cn fn nL nH (cn=51, fn=71)**

[Name]	2D GS1 DataBar: Set The maximum width of the 2D GS1DataBar Expanded Stacked										
[Code]	ASCII	ESC	GS	(	k	pL	pH	cn	fn	nL	nH
	Hex.	1B	1D	28	6B	pL	pH	cn	fn	nL	nH
	Decimal	27	29	40	107	pL	pH	cn	fn	nL	nH
[Defined Area]	pL = 4, pH = 0 cn = 51 fn = 71 $106 \leq n \leq 3952$										
[Initial Value]	$(nL + nH \times 256) = 141$ (nL = 141, nH = 0)										
[Function]	The maximum width of the 2D GS1DataBar Expanded Stacked is set to n dots.										
[Details]	The setting for this function affects the processing of function 381. This setting is enabled until ESC@ is executed, the printer is reset, or the power is turned off. The set unit is 1 dot. The width is set as 0.125 mm (1/203 inches).										
[Reference]	ESC GS ( k Function 381 , ESC @										

## <Function 380> ESC GS ( k pL pH cn fn m n d1...dk (cn=51, fn=80)

[Name] 2D GS1 DataBar: Store data in symbol saving region

[Code] ASCII ESC GS ( k pL pH cn fn m n d1 ... dk  
 Hex. 1B 1D 28 6B pL pH cn fn m n d1 ... dk  
 Decimal 27 29 40 107 pL pH cn fn m n d1 ... dk

[Defined Area]  $4 \leq (pL + pH \times 256) \leq 259$  ( $0 \leq pL \leq 255$ ,  $pH = 0, 1$ )  
 cn = 51  
 fn = 80  
 m = 48  
 n = 72, 73, 76  
 $0 \leq d \leq 255$   
 $k = (pL + pH \times 256) - 4$

[Function] Symbol data (d1...dk) for the 2D GS1 DataBar is stored in the symbol saving region.

n	Type of Symbol	Data (k)	ASCII	Data (d)
72	GS1 Databar Stacked	k = 13	"0" to "9"	$48 \leq d \leq 57$
73	GS1 Databar Stacked Omnidirectional	k = 13	"0" to "9"	$48 \leq d \leq 57$
76	GS1 Databar Expanded Stacked	$2 \leq k \leq 255$	0~9, A~Z, a~z SP, !, ", %, \$, ', (, ), *, +, ,, -, ., /, :, ;, <, =, >, ?, _ , {	$48 \leq d \leq 57, 65 \leq d \leq 90, 97 \leq d \leq 122$ , $32 \leq d \leq 34, 37 \leq d \leq 47, 58 \leq d \leq 63$ , d = 95, 123 [However $d1 = 40, 48 \leq d2 \leq 57, 48 \leq d3 \leq 57, 48 \leq d1 \leq 57, 48 \leq d2 \leq 57$ ]

[Details] Data stored in the symbol saving region by this function is processed using function 381.  
 After processing functions 381 and 382, data in the saving region is maintained.  
 k bytes for d1...dk are processed as symbol data.  
 This setting is valid until this function is reset, ESC@ is executed, the printer is reset, or the power is off.

[Reference] ESC GS ( k Function 381 , ESC @

## <Function 381> ESC GS ( k pL pH cn fn m (cn=51, fn=81)

[Name]	2D GS1 DataBar: Print symbol data of symbol saving region									
[Code]	ASCII	ESC	GS	(	k	pL	pH	cn	fn	m
	Hex.	1B	1D	28	6B	pL	pH	cn	fn	m
	Decimal	27	29	40	107	pL	pH	cn	fn	m

[Defined Area] pL = 3, pH = 0  
 cn = 51  
 fn = 81  
 m = 48

[Function] Executes encoding and printing of the symbol data stored in the symbol saving region by ESC GS ( k function 380.

[Note] The user must secure the quiet zone.

[Reference] ESC GS ( k Function 380

[Details] This command prints bar code data or deploys it to the image buffer.  
 This command is ignored when one of the following errors occurs:

- Error that occurs when the bar code is generated due to the combination of each barcode setting command.
- When the generated bar code data exceeds the printable size for the GS1 DataBar.
- When the print data exceeds the current set print area.

Make sure you check the printed bar code before actual use.

For standby mode:

- If unprinted data still exists in the line buffer, the buffered data is printed out, the command is executed, and then the bar code is printed. Therefore, you cannot print mixed data (characters, bit images, bar codes) on the same line.

For page mode:

- This command only deploys bar code data to the image buffer.

### **<Function 467> ESC GS ( k pL pH cn fn n (cn=52, fn=67)**

[Name]	Compound symbol: Set module width									
[Code]	ASCII	ESC	GS	(	k	pL	pH	cn	fn	n
	Hex.	1B	1D	28	6B	pL	pH	cn	fn	n
	Decimal	27	29	40	107	pL	pH	cn	fn	n

[Defined Area] pL = 3, pH = 0  
 cn = 52  
 fn = 67  
 $2 \leq n \leq 8$

[Initial Value] n = 2

[Function] The width of one module for compound symbols is set to n dots.

[Details] The setting for this function affects the processing of function 481.  
 This setting is enabled until ESC@ is executed, the printer is reset, or the power is turned off.  
 The set unit is 1 dot.  
 The width is set as 0.125 mm (1/203 inches).

[Reference] ESC GS ( k Function 481, ESC @

### **<Function 471> ESC GS ( k pL pH cn fn nL nH (cn=52, fn=71)**

[Name]	Compound symbol: Set The maximum width of the 2D GS1DataBar Expanded Stacked										
[Code]	ASCII	ESC	GS	(	k	pL	pH	cn	fn	nL	nH
	Hex.	1B	1D	28	6B	pL	pH	cn	fn	nL	nH
	Decimal	27	29	40	107	pL	pH	cn	fn	nL	nH

[Defined Area] pL = 4, pH = 0  
 cn = 52  
 fn = 71  
 $106 \leq n \leq 3952$

[Initial Value]  $(nL + nH \times 256) = 141$  (nL = 141, nH = 0)

[Function] The maximum width of the GS1DataBar Expanded Stacked in compound symbols is set to n dots.

[Details] The setting for this function affects the processing of function 481.  
 This setting is enabled until ESC@ is executed, the printer is reset, or the power is turned off.  
 The set unit is 1 dot.  
 The width is set as 0.125 mm (1/203 inches).

[Reference] ESC GS ( k Function 481, ESC @

## <Function 472> ESC GS ( k pL pH cn fn n (cn=52, fn=72)

[Name] Compound symbol: Set the HRI font

[Code] ASCII      ESC GS ( k pL pH cn fn n  
 Hex.          1B 1D 28 6B pL pH cn fn n  
 Decimal      27 29 40 107 pL pH cn fn n

[Defined Area] pL = 3, pH = 0  
 cn = 52  
 fn = 72  
 $0 \leq n \leq 2, 48 \leq n \leq 50$

[Initial Value] n = 0

[Function] Select the font for HRI characters when printing combined symbols.

n	HRI font
0, 48	not printed
1, 49	printed (Select font A(12x24))
2, 50	printed (Select font B(9x24))

[Details] Data stored in the symbol saving region by this function is processed using function 481.  
 When "Print" HRI is selected, HRI is printed under 1D bar codes.  
 When the combined symbol uses a 2D code (GS1 DataBar Stacked, GS1 DataBar Stacked Omnidirectional, GS1 DataBar Expanded Stacked), this setting is not affected and HRI is not printed.  
 This setting is valid until this function is reset, ESC@ is executed, the printer is reset, or the power is off.

[Reference] ESC GS ( k Function 481, ESC @

## <Function 480> ESC GS ( k pL pH cn fn m a b d1...dk (cn=52, fn=80)

[Name] Compound symbol: Store data in symbol saving region  
 [Code] ASCII ESC GS ( k pL pH cn fn m a b d1 ... dk  
 Hex. 1B 1D 28 6B pL pH cn fn m a b d1 ... dk  
 Decimal 27 29 40 107 pL pH cn fn m a b d1 ... dk

[Defined Area]  $7 \leq (pL + pH \times 256) \leq 2366$  ( $0 \leq pL \leq 255$ ,  $0 \leq pH \leq 9$ )  
 cn = 52  
 fn = 80  
 m = 48  
 a = 48,49  
 $65 \leq b \leq 77$  (a=48)  
 b = 65,66 (a=49)  
 $0 \leq d \leq 255$   
 $k = (pL + pH \times 256) - 5$

[Function] Symbol data (d1...dk) for the Compound symbol: is stored in the symbol saving region.

a = 48

b	Bar Code Type	Data (k)	ASCII	Data (d)
65	EAN8	k = 7,8	"0"to"9"	$48 \leq d \leq 57$
66	EAN13	k = 12,13	"0"to"9"	$48 \leq d \leq 57$
67	UPC-A	k = 11,12	"0"to"9"	$48 \leq d \leq 57$
69	UPC-E (11-digit version (0 included))	k = 11,12	"0"to"9"	$48 \leq d \leq 57$
70	GS1 DataBar Omnidirectional	k = 13	"0"to"9"	$48 \leq d \leq 57$
71	GS1 DataBar Truncated	k = 13	"0"to"9"	$48 \leq d \leq 57$
72	GS1 DataBar Stacked	k = 13	"0"to"9"	$48 \leq d \leq 57$
73	GS1 DataBar Stacked Omnidirectional	k = 13	"0"to"9"	$48 \leq d \leq 57$
74	GS1 DataBar Limited	k = 13	"0"to"9"	$48 \leq d \leq 57$ [However d1 = 48,49]
75	GS1 DataBar Expanded	$2 \leq k \leq 255$	0~9, A~Z, a~z SP, !, ", %, \$, ', (, ), *, +, ,, -, ., /, :, ;, <, =, >, ?, _, {	$48 \leq d \leq 57$ , $65 \leq d \leq 90$ , $97 \leq d \leq 122$ , $32 \leq d \leq 34$ , $37 \leq d \leq 47$ , $58 \leq d \leq 63$ , d = 95,123 [However d1 = 40, $48 \leq d2 \leq 57$ , $48 \leq d3 \leq 57$ , $48 \leq d1 \leq 57$ , $48 \leq d2 \leq 57$ ]
76	GS1 DataBar Expanded Stacked	$2 \leq k \leq 255$	0~9, A~Z, a~z SP, !, ", %, \$, ', (, ), *, +, ,, -, ., /, :, ;, <, =, >, ?, _, {	$48 \leq d \leq 57$ , $65 \leq d \leq 90$ , $97 \leq d \leq 122$ , $32 \leq d \leq 34$ , $37 \leq d \leq 47$ , $58 \leq d \leq 63$ , d = 95,123 [However d1 = 40, $48 \leq d2 \leq 57$ , $48 \leq d3 \leq 57$ , $48 \leq d1 \leq 57$ , $48 \leq d2 \leq 57$ ]
77	GS1-128	$2 \leq k \leq 255$		$0 \leq d \leq 127$

a = 49

b	Type of Symbol	Data (k)	Data (d)
65	CC-A, CC-B, CC-C Automatic distinction by a digit number.	$3 \leq k \leq 2361$	$32 \leq d \leq 127$
66	fixing to CC-C	$3 \leq k \leq 2361$	$32 \leq d \leq 127$

[Details] Data stored in the symbol saving region by this function is processed using function 481.  
 After processing functions 481, data in the saving region is maintained.  
 k bytes for d1...dk are processed as symbol data.

This setting is valid until this function is reset, ESC@ is executed, the printer is reset, or the power is off.

[Reference] ESC GS ( k Function 481, ESC @

## <Function 481> ESC GS ( k pL pH cn fn m (cn=52, fn=81)

[Name] Compound symbol: Printe data in symbol saving region

[Code]	ASCII	ESC	GS	(	k	pL	pH	cn	fn	m
	Hex.	1B	1D	28	6B	pL	pH	cn	fn	m
	Decimal	27	29	40	107	pL	pH	cn	fn	m

[Defined Area] pL = 3, pH = 0  
 cn = 52  
 fn = 81  
 m = 48

[Function] Executes encoding and printing of the symbol data stored in the symbol saving region by GS ( k function 480.

[Note] The user must secure the quiet zone.

[Reference] GS ( k Function 480

[Details] This command prints bar code data or deploys it to the image buffer.

This command is ignored when one of the following errors occurs:

- Error that occurs when the bar code is generated due to the combination of each barcode setting command.
  - When the generated bar code data exceeds the printable size for the GS1 DataBar.
  - When the print data exceeds the current set print area.
- Make sure you check the printed bar code before actual use.

For standby mode:

- If unprinted data still exists in the line buffer, the buffered data is printed out, the command is executed, and then the bar code is printed. Therefore, you cannot print mixed data (characters, bit images, bar codes) on the same line.

For page mode:

- This command only deploys bar code data to the image buffer.



### 2.3.18. Initialization Command

#### **ESC @**

[Name]	Command initialization		
[Code]	ASCII	ESC	@
	Hex.	1B	40
	Decimal	27	64

[Defined Area] ---

[Initial Value] ---

[Function] In standard mode, the commands are initialized after the data in the line buffer was printed. However, printers with memory switch/ Star Configuration settings are initialized to those settings. In case of the model with DIPSW, DIPSW re-reading is not performed. In page mode, the entire print region is cleared and the mode changes back to standard mode.

- ANK characters, Kanji character adornment, expansion
- Kanji character mode
- ANK right space
- Kanji character left/right spaces
- Character pitch
- International characters
- Code page
- Set slash zero
- Set specify/cancel external character (external register character data is retained)
- Page length
- Current position (move to top of page, top of line)
- Horizontal tab
- Line feed amount
- Set upside-down, position alignment
- Left/right margins
- Top margin

The following shows the specifications that are not initialized by this command.

- Set print density
- Set print speed
- Set 2 color print mode
- Print color in 2 color print mode
- External device drive condition
- Media type settings

#### **ESC ACK CAN**

[Name]	Execute real-time printer reset		
[Code]	ASCII	ESC	ACK CAN
	Hexadecimal	1B	06 18
	Decimal	27	6 24

[Defined Area] ---

[Initial Value] ---

[Function] Execute real-time printer reset.

[Limitations by model]

mPOP, mC-Print2, mC-Print3, mC-Label3 :  
 Execution of this command during printing may be delayed.  
 Reconnection is required, because the connection between printer and host is disconnected by the execution of this command.

## ESC ? LF NUL

[Name]	Reset printer (execute self print)				
[Code]	ASCII	ESC	?	LF	NUL
	Hex.	1B	3F	0A	00
	Decimal	27	63	10	0

[Defined Area] ---

[Initial Value] ---

[Function] Hardware resets the printer and executes on self print.  
 After sending this command, the next data is not sent until the printer is online (in a state wherein it can receive data).

### 2.3.19. Memory Switch Setting Command

#### **ESC GS # m N n1 n2 n3 n4 LF NUL**

[Name]	Set memory switch											
[Code]	ASCII	ESC	GS	#	m	N	n1	n2	n3	n4	LF	NUL
	Hex.	1B	1D	23	m	N	n1	n2	n3	n4	0A	00
	Decimal	27	29	35	m	N	n1	n2	n3	n4	10	0

[Defined Area]  $48 \leq n1 \leq 57$  ("0"  $\leq$  n1  $\leq$  "9"),  $65 \leq n1 \leq 70$  ("A"  $\leq$  n1  $\leq$  "F"),  $97 \leq n1 \leq 102$  ("a"  $\leq$  n1  $\leq$  "f")  
 $48 \leq n2 \leq 57$  ("0"  $\leq$  n2  $\leq$  "9"),  $65 \leq n2 \leq 70$  ("A"  $\leq$  n2  $\leq$  "F"),  $97 \leq n2 \leq 102$  ("a"  $\leq$  n2  $\leq$  "f")  
 $48 \leq n3 \leq 57$  ("0"  $\leq$  n3  $\leq$  "9"),  $65 \leq n3 \leq 70$  ("A"  $\leq$  n3  $\leq$  "F"),  $97 \leq n3 \leq 102$  ("a"  $\leq$  n3  $\leq$  "f")  
 $48 \leq n4 \leq 57$  ("0"  $\leq$  n4  $\leq$  "9"),  $65 \leq n4 \leq 70$  ("A"  $\leq$  n4  $\leq$  "F"),  $97 \leq n4 \leq 102$  ("a"  $\leq$  n4  $\leq$  "f")

m = 87, 84, 44, 43, 45, 64, 42 (m = "W", "T", ",", "+", "-", "@", "\*")

$48 \leq N \leq 57$  ("0"  $\leq$  N  $\leq$  "9"),  $65 \leq N \leq (*)70$  ("A"  $\leq$  N  $\leq$  (\*)"F"),  $97 \leq N \leq (*) 102$ , ("a"  $\leq$  N  $\leq$  (\*) "f")

N = 85 (N = "U") User defined area

(\*) The memory switch defined area differs according to the model.

[Initial Value] - - -

[Function] Sends command to write after defining memory switch using the definition command specified by the following classes.

Memory switch information defined by the command to write is written to the volatile memory.

When writing to the volatile memory by the command to write, the printer executes a reset.

You can register any 16 bit data by specifying N = 85 ("U").

You can load the default settings by specifying m = 42 (\*).

Consider the life of the non-volatile memory and avoid excessive use of this command.

Functions	Class	m	N	n1 n2 n3 n4
Definition data write and reset	Write	"W"	Fixed at "0"	Fixed at "0000"
Definition data write and reset and self print	Write	"T"	Fixed at "0"	Fixed at "0000"
Data definition (data specification)	Definition	","	N	n1 n2 n3 n4
Data definition (specify bit and set)	Definition	"+"	N	n1 n2 n3 n4
Data definition (specify bit and clear)	Definition	"-"	N	n1 n2 n3 n4
Definition data (all bit initialized)	Definition	"@"	Fixed at "0"	Fixed at "0000"
Definition data (load default settings)	Definition	"*"	Fixed at "0"	Fixed at "0000"

• m : Mode selection

• N : Memory switch number to specify

• n1 n2 n3 n4 : Specify data m = ("," Specify data

m = ("+" Bit number to set

m = ("-") Bit number to clear

[Model Limitations]

SM-L200, SM-S/T series: The m=42 (m="\*") data definition (load default settings) function is not supported.

### 2.3.20. Status

#### ESC RS a n

[Name] Set status transmission conditions  
 [Code] ASCII ESC RS a n  
 Hex. 1B 1E 61 n  
 Decimal 27 30 97 n

[Defined Area]  $0 \leq n \leq 3, 48 \leq n \leq 51$  ("0"  $\leq n \leq$  "3")  
 $n=16, n=255$

[Initial Value] Memory switch / Star Configuration setting

[Function] Sets the status transmission conditions.  
 See [Appendix 2](#) for details regarding ASB status.  
 Settings of this command are unaffected by the ESC @ command.  
 See each printer's product specifications manual for details on the memory switch settings.

The command functions can be selected using the memory switch.  
 Therefore, the command specifications vary depending on the memory switch setting as follows.  
 When command function selection by memory switches is unsupported, Status Transmission Condition Setting Function is fixed.

n	Command function selection by memory switches	
	Status transmission conditions	Status transmission
0, 48	ASB Invalid • NSB Invalid	Status transmission
1, 49	ASB Valid • NSB Invalid	
2, 50	ASB Invalid • NSB Valid	
3, 51	ASB Valid • NSB Valid	
16	Returns the ASB and NSB settings to the initial state set by the memory switches or specified by Star Configuration.	
255	Sends the ASB status information.	

#### ESC ACK SOH

[Name] Real-time printer status (ASB status)  
 [Code] ASCII ESC ACK SOH  
 Hex. 1B 06 01  
 Decimal 27 6 1

[Defined Area] ---

[Initial Value] ---

[Function] Sends ASB status information to the host.  
 This command is not used when ASB is valid.  
 See [Appendix 2](#), Automatic Status for details regarding ASB status.

## ETB

[Name] Update ASB ETB status  
 [Code] ASCII ETB  
 Hex. 17  
 Decimal 23

[Defined Area] ---

[Initial Value] ---

[Function] Sets the ASB ETB status when reading this command from the reception buffer.  
 Then, after updating the ASB ETB counter, sends the ASB status.  
 See [Appendix 2, ASB Status](#) for details of ABS Status.

The following outlines the details of processes in this command.

- (1) Reads ETB command from reception buffer.
- (2) Waits for printing of the print data before the ETB command to end.
- (3) Increments the ASB ETB counter by 1 after checking that printing has ended, then sets the ASB ETB status.
- (4) Sends ASB (only when ASB is enabled).

### ■ Precautions when using Ethernet

When multi-session is valid the ASB (ETB counter) sent by <ETB> is sent to all hosts that are connected. For that reason, sending ETB from multiple sessions, can cause misrecognition of the ETB counter. Therefore, we recommend the <ESC><GS><ETX> commands to confirm the print end counter. See the Command List by Model.

## ESC RS E n

[Name] Initialize ASB ETB counter and ETB status  
 [Code] ASCII ESC RS E n  
 Hex. 1B 1E 45 n  
 Decimal 27 30 69 n

[Defined Area] n = 0  
 n = 48 ("0")

[Initial Value] ASB ETB counter = 0

[Function] Clears the ASB ETB counter to zero, then clears the ETB status.  
 However, ASB status is not send when clearing the ETB counter to zero using this command.

## ESC GS ETX s n1 n2

[Name] Send print-end counter, initialize  
 [Code] ASCII ESC GS ETX s n1 n2  
 Hex. 1B 1D 03 s n1 n2  
 Decimal 27 29 3 s n1 n2

[Defined Area] Spec. 1:  $0 \leq s \leq 4$   
 Spec. 2:  $0 \leq s \leq 5$   
 Spec. 3:  $0 \leq s \leq 4$   
 $0 \leq n1 \leq 255, 0 \leq n2 \leq 255$

[Function] This command is run when reading from the reception buffer. Processes the print end counter according to the s parameter.

s	Name	Function
0	Print end counter reference	Sends the current print end counter to the host. (Does not wait for print end. Does not count up.)
1	Print end counter update	Runs the following operations. (1) Prints data in line buffer, if data exists. (2) Waits until printing ends (motor stops). (3) Updates the print end counter (increments by 1). (4) Sends print end counter to host.
2	Print end counter clear	Returns the print end counter to its default value (zero clear). (Does not wait for print end. Does not send the print end counter to the host.)
3	Spec.1, 2 Start document  Spec. 3 When spooler function is invalid Start document When spooler function is valid Start spooler storage  n1, n2 = 0	Spec.1, 2 (1) Sets data intake mode (2) Initialize  Spec. 3 When spooler function is invalid 1. Sets data intake mode 2. Initialize When spooler function is valid Start spooler storage with retry disabled and set to no timeout setting
4	Spec.1, 2 End document  Spec 3. When spooler function is invalid End document When spooler function is valid End spooler storage  n1, n2 = 0	Spec.1, 2 (1) Prints data in line buffer, if data exists. (2) Waits until printing ends (motor stops). (3) Cancels data intake mode  Spec. 3 When spooler function is invalid 1. Prints data in line buffer, if data exists. 2. Waits until printing ends (motor stops). 3. Cancels data intake mode. When spooler function is valid End spooler storage
5	Data timeout setting	n1=0: Initializes to the content of memory switch / Star Configuration. (n2=0) n1=1: Data timeout setting n2=0: Timeout disabled Others: n2 = Data timeout time (units: seconds 1 to 255 seconds) n1=2: Sends the current timeout setting to the host. (n2=0)

The data formats sent to the host when s = 0 or s = 1 is shown below.

<Returned Data Formats>

[Code]	ASCII	ESC	GS	ETX	s	n1	n2	[Print end counter]	NUL
	Hexadecimal	1B	1D	03	s	n1	n2	[Print end counter]	00
	Decimal	27	30	3	s	n1	n2	[Print end counter]	0

Note) Echoes back the specified contents from the host as is until ESC GS ETX s n1 n2, and then sends the print end counter value and NUL.

When [Print end counter] is 1 byte in length, the initial value is 0x00.

When s = 1, increments by 1 each time the command is processed. After 0xFF, returns to 0x00.

There is one [Print end counter] in the printer that is unrelated to the n1, n2 values.

(There is no counter for the n1, n2 values.)

(Reference Information) Differences between the ETB command and this command

Item	ESC GS ETX s n1 n2	ETB
Affect on ASB (ETB Status)	None	Yes
ASB occurrence	None	Yes
Affect of ASB valid/invalid setting	None	Yes
Affect of the ESC RS E n command	None	Yes
Status transmission destination in Ethernet (When multi-sessions is valid)	Send only when in the print session (host) that is connected	Send ASB to all sessions (hosts) that are connected

Note) This print end counter and the ETB counter sent by the ETB command are separate. They have no affect on each other.

The following shows a communication example of this command.

Communication Example 1

Host Transmission Data	Printer return data
ESC GS ETX <b>0x00</b> 0x00 0x00	→ ← ESC GS ETX <b>0x00</b> 0x00 0x00 0x00 0x00 (Reference Counter)
Print Data + ESC GS ETX <b>0x01</b> 0x00 0x00	→ ← ESC GS ETX <b>0x01</b> 0x00 0x00 0x01 0x00 (Reference Update)
Print Data + ESC GS ETX <b>0x01</b> 0x00 0x00	→ ← ESC GS ETX <b>0x01</b> 0x00 0x00 0x02 0x00 (Reference Update)

Communication Example 2

Host Transmission Data	Printer return data
ESC GS ETX <b>0x02</b> 0x02 0x00	(Clear Counter)
ESC GS ETX <b>0x00</b> 0x02 0x00	→ ← ESC GS ETX <b>0x00</b> 0x02 0x00 0x00 0x00 (Reference Counter)
Print Data + ESC GS ETX <b>0x01</b> 0x02 0x11	→ ← ESC GS ETX <b>0x01</b> 0x02 0x11 0x01 0x00 (Reference Update)
Print Data + ESC GS ETX <b>0x01</b> 0x02 0x12	→ ← ESC GS ETX <b>0x01</b> 0x02 0x12 0x02 0x00 (Reference Update)
Print Data + ESC GS ETX <b>0x01</b> 0x02 0x13	→ ← ESC GS ETX <b>0x01</b> 0x02 0x13 0x03 0x00 (Reference Update)
Print Data + ESC GS ETX <b>0x01</b> 0x02 0x14	→ ← ESC GS ETX <b>0x01</b> 0x02 0x14 0x04 0x00 (Reference Update)

<Example using n1, n2>

- Specify n1+n2 x 256 as the document ID and check the compatibility with the document ID in the same way.
- When it is not possible to check compatibility of the source and returned data, fix at n1 = 0, n2 = 0.

When  $s = 3$ , and  $s = 4$  (Document start command + document end command), printer operates as though in data cancel mode.

If there is an error after receiving the document start command, reception data is received and discarded until the document end command is received when the printer is recovered from the error.

If the document end command cannot be recognized, all reception data is destroyed. (data intake mode)

Data receiving timeout is 10 seconds. When no data is received continuously for 10 seconds, data intake mode is automatically canceled.

#### Restrictions

- 1) Sleep mode decrease
- 2) Erroneous printing occurs if the same data as the End command is contained in the raster data or bit image data.
- 3) Invalid when in Page mode

When  $S=3$  is specified, an initialization processing is executed as same as `<ESC> "@`".

`<T:TOP Command/E:END Command>`

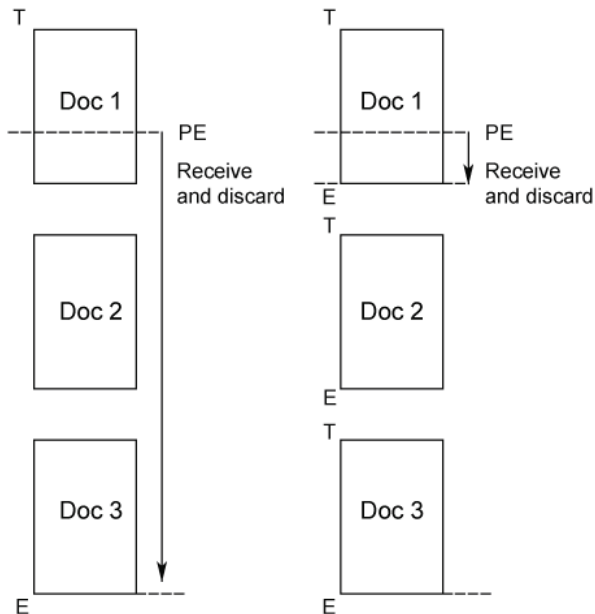

The interface disconnection detection function through data reception timeout is controlled when  $s=5$  is specified.

When this function is enabled, the interface is determined to have been disconnected when no data is received for a specified period of time at the data read section of the printer.

When a disconnection is detected during a command execution, the command parsing is stopped.

$n1=0$  and  $n2=0$ : Initializes the interface disconnection detection function through data reception timeout.  
(Returns to the memory switch / Star Configuration settings. The initial value for the timeout time is 3 seconds.)

$n1=1$  : Set enable/disable and the timeout time for data reception timeouts.  
When  $n2$  is 0, the disconnection detection function is disabled due to data reception timeouts.  
When  $n2$  is anything except for 0, the data reception timeout is set. (Units: seconds, 1 to 255 seconds)

$n1=2$  and  $n2=0$ : Sends the current setting to the host.  
The data format returned to the host is as shown below.

`<Returned Data Formats>`

[Code]	ASCII	ESC	GS	ETX	s	n1	n2	[timeout setting]	NUL
	Hex.	1B	1D	03	s	n1	n2	[timeout setting]	00
	Decimal	27	29	3	s	n1	n2	[timeout setting]	0

Note) Echoes back the specified contents from the host as is until ESC GS ETX s n1 n2, and then sends the print end counter value and NUL.

This function is invalid at the time of program rewriting.



### **ESC # \* LF NUL**

[Name] Get printer version

[Code]	ASCII	ESC	#	*	LF	NUL
	Hex.	1B	23	2A	0A	00
	Decimal	27	35	42	10	0

[Defined range] ---

[Initial Value] ---

[Function] Transmits the printer version.  
 ESC # \* , "printer version" LF NUL  
 <Example for mPOP Ver1.0: ESC # \* , mPOP Ver1.0 LF NUL >

### **ESC GS ) I pL pH fn [parameter]**

[Name] Transmit printer information

[Code]	ASCII	ESC	GS	)	I	pL	pH	fn	[parameter]
	Hex.	1B	1D	29	49	pL	pH	fn	[parameter]
	Decimal	27	29	41	73	pL	pH	fn	[parameter]

[Function] Executes printer information processing.  
 - "pL" and "pH" specify the number of parameters after "fn" as "pL + pH \* 256" bytes.  
 - See the function specifications for details on [parameter].

fn	Function No.	Function Name
48	Function 48	Transmit all types of multibyte fonts
49	Function 49	Transmit printer information
50	Function 50	Transmit the remaining battery power
51	Function 51	Transmit installed I/F kind
52	Function 52	Transmit external device information

## <Function 48> ESC GS ) I pL pH fn d1 d2

[Name] Transmit all types of multibyte fonts

[Code]	ASCII	ESC	GS	)	I	pL	pH	fn	d1	d2
	Hex.	1B	1D	29	49	pL	pH	fn	d1	d2
	Decimal	27	29	41	73	pL	pH	fn	d1	d2

[Defined range] pL = 3, pH = 0  
fn = 48  
d1 = 0, d2 = 0

[Function] Transmits all types of multibyte fonts installed in the printer.

[Detail] Information is transmitted in the following format:  
ESC GS ) I pL pH fn k1 k2 [multibyte font type 1, multibyte font type 2, ...] LF NUL  
Where, k1 and k2 indicate the number of data bytes (k1+k2x256) transmitted after the multibyte font type.  
When two or more multibyte fonts are installed, the fonts are transmitted separated by a separator (2Ch).

The multibyte font type is transmitted as a character string.

Multibyte font type	Transmitted character string
Japanese	KANJI JAPANESE
Simplified Chinese GB2312	CHINA GB2312
Simplified Chinese GB18030	CHINA GB18030
Traditional Chinese BIG5	TAIWAN BIG-5
Korean	KOREA C-5601C

Example: When simplified Chinese GB18030 and standard Chinese BIG5 are installed, the following is transmitted.

ESC GS ) I pL pH fn k1 k2 CHINA GB18030 , TAIWAN BIG-5 , LF NUL (Where, k1 = 29, k2 = 0)

When no multibyte font is installed, the following is transmitted.

ESC GS ) I pL pH fn k1 k2 LF NUL

## <Function 49> ESC GS ) I pL pH fn

[Name]	Transmit Printer Information							
[Code]	ASCII	ESC	GS	)	I	pL	pH	fn
	Hex.	1B	1D	29	49	pL	pH	fn
	Decimal	27	29	41	73	pL	pH	fn

[Defined range] pL = 1, pH = 0  
fn = 49

[Function] Transmit the printer information.

[Detail] Information is transmitted in the following format:  
ESC GS ) I pL pH fn [Tag name = parameter, Tag name = parameter,...] LF NUL

Each parameter is accompanied by the tag name on the top and sent correspondingly to its tag name.

The tag name is followed by an equal sign and the subsequent part is the parameter.

Each set of a tag and a parameter is separated by a delimiter “, “ (2CH).

The number of parameters varies depending on the printer which is transmitting information.

Information (a set of a tag and a parameter) is transmitted in order from the top of the list shown below only if it corresponds to the printer.

LF NUL represents a termination, and the tag and its parameter are not transferred afterward.

The parameter is transmitted as a character string.

When HW Ver = 1.0

ESC GS ) I pL pH fn PrHwV=1.0 LF NUL

When information can't be acquired, the data below is sent.

ESC GS ) I pL pH fn LF NUL

Sent order	Tag	Parameter information		Spec
↓	PrHwV	Printer HW Ver.	*1	Spec.1, 2, 3, 4, 5, 7, 8, 9, 10,11,12
↓	PrSrN	Product Serial Number	Fixed 16 digits ("NUL" is filled when less than 16 digits.)	Spec.1, 2, 3, 4, 5, 6, 7, 8, 9, 10,11,12
↓	BtDvN	Bluetooth Device Name	Fixed 16 digits ("NUL" is filled when less than 16 digits.) *3	Spec.1, 2, 3, 4, 5, 8, 9,11,12
↓	BtAtC	Bluetooth AutoConnection	AutoConnection invalid: BtAtC=00 valid: BtAtC=01 *2, *3	Spec.1, 2, 3, 4, 5, 8, 9,11,12
↓	BtIpN	Bluetooth iOS Port Name	Fixed 16 digits ("NUL" is filled when less than 16 digits.) *3	Spec.1, 2, 3, 4, 5, 8, 9,11,12
↓	BtNpP	Bluetooth New Pairing	New Pairing invalid: BtNpP=00 valid: BtNpP=01 *3	Spec.1, 2, 8,12
↓	BtDsC	Bluetooth Search Permission Setting	Search prohibited: BtDsC=00; Search permitted: BtDsC=01 *3	Spec.3, 4, 5, 9,11,12
↓	BtAdS	Bluetooth Address	Fixed 12 digits *3	Spec.3, 4, 5, 9,11,12
↓	LaNmA	LAN MAC Address	Fixed 12 digits	Spec.3, 4, 5, 7, 9, 10,11
↓	UsSrN	USB Serial Number	Maximum 16 digits	Spec.3, 4, 5, 7, 8, 9, 10,11,12
↓	PrFnV	Font File Ver.	Maximum 16 digits	Spec.2, 5, 7, 8, 10,11,12
↓	PrMdL	Printer Model Name		Spec.10,11,12

[Model limitation]

\*1 :

mPOP: Handling of Printer Hardware Version depending on the FW version.

< F/W Ver1.3 or older >

1.0 is returned.

< F/W Ver.2.0 or later >

If a circuit board which supports DK ports is equipped, 2.0 or 3.0 is returned.

If a circuit board which does not support DK ports is equipped, 1.0 or 4.0 is returned.

\*2 :

mC-Print : LB model only

Tag is not returned by models which do not support Bluetooth or CB models.

\*3 :

Models supporting Bluetooth only

Tag is not returned by models which do not support it.

## <Function 50> ESC GS ) I pL pH fn

[Name]	Transmit the remaining battery power							
[Code]	ASCII	ESC	GS	)	I	pL	pH	fn
	Hex.	1B	1D	29	49	pL	pH	fn
	Decimal	27	29	41	73	pL	pH	fn

[Defined range] pL = 1, pH = 0  
fn = 50

[Function] Transmit the remaining battery power.

[Detail] Information is transmitted in the following format:  
ESC GS ) I pL pH fn [Tag name = parameter, Tag name = parameter,...] LF NUL

Each parameter is accompanied by the tag name on the top and sent correspondingly to its tag name.

The tag name is followed by an equal sign and the subsequent part is the parameter.

Each set of a tag and a parameter is separated by a delimiter “,” (2CH).

The number of parameters varies depending on the printer which is transmitting information.

Information (a set of a tag and a parameter) is transmitted in order from the top of the list shown below only if it corresponds to the printer.

LF NUL represents a termination, and the tag and its parameter are not transferred afterward.

The parameter is transmitted as a character string.

When a battery is empty.

ESC GS ) I pL pH fn PrBtY=Empty LF NUL

When information can't be acquired, the data below is sent.

ESC GS ) I pL pH fn LF NUL

ent order	Tag	Parameter information	
↓	PrBtY	Remaining battery power	Near Empty: PrBtY=Empty Low: PrBtY=Low High: PrBtY=High Full: PrBtY=Full
↓	(Undefined)	(Undefined)	(Undefined)
↓	(Undefined)	(Undefined)	(Undefined)

## <Function 51> ESC GS ) I pL pH fn d1 d2

[Name] Transmit installed I/F kind

[Code]	ASCII	ESC	GS	)	I	pL	pH	fn	d1	d2
	Hex.	1B	1D	29	49	pL	pH	fn	d1	d2
	Decimal	27	29	41	73	pL	pH	fn	d1	d2

[Defined range] pL = 3, pH = 0  
fn = 51  
d1 = 0, d2 = 0

[Function] All kinds of I/F installed in the printer are transmitted.  
I/F represents the StarPRNT command reception port.

[Detail] Information is transmitted in the following format:  
ESC GS ) I pL pH fn k1 k2 [I/F type1, I/F type2, .....] LF NUL  
k1 and k2 indicate the number of transmission data bytes (k1+k2x256) after the I/F types.  
When there are multiple I/F types in the printer, they are delimited by commas (2Ch).  
The kind of I/F type is sent as character string data.

I/F Type	Transmitting string
USB-B	USB-B
USB-A(iOS)	USB-A
Bluetooth	BT-I
Ethernet	ETHERNET
USB-C	USB-C
Bluetooth (iOS not supported)	BT
USB-A(Android)	USB-A-AOA
USB-C (iOS)	USB-C-I

Example:

When USB-B, USB-A, Bluetooth and Ethernet are installed in the printer:  
ESC GS ) I pL pH fn k1 k2 USB-B,USB-A,BT-I,ETHERNET,LF NUL  
(However, k1 = 28, k2 = 0)

## <Function 52> ESC GS ) I pL pH fn d1 d2

[Name]	Transmit external device information									
[Code]	ASCII	ESC	GS	)	I	pL	pH	fn	d1	d2
	Hex.	1B	1D	29	49	pL	pH	fn	d1	d2
	Decimal	27	29	41	73	pL	pH	fn	d1	d2

[Defined range] pL = 3, pH = 0  
fn = 52  
d1 = 0, d2 = 0

[Function] Transmits information about the external device connected to the printer.

[Detail] Information is transmitted in the following format:  
ESC GS ) I pL pH fn k1 k2 [external device information1, external device information 2 , .....] LF  
NUL

k1 and k2 indicate the number of transmission data bytes (k1+k2x256) after the external device information.

When there are a lot of information about external devices, they are delimited by commas (2Ch).

Example: When a MCS10 is connected to the external device and the MCS10 FW version is 1.0.

ESC GS ) I pL pH fn k1 k2 DkMdl=MCS10 , DkVer=1.0 , LF NUL (k1 = 24, k2 =0)

When an external device is not connected or when a connected external device is not supported by this function, only the tags related to the corresponding external device are transmitted.

Example: When an external device is not connected to the external device connection terminal of a model that supports tags DkMdl and DkVer.

ESC GS ) I pL pH fn k1 k2 DkMdl=, DkVer=, LF NUL

Tag	Parameter information	
DkMdl	External device connection terminal Connected device model information	Model Name: MCS10 : DkMdl=MCS10 When these tags are transmitted from the printer, the data for tag DkVer is also transmitted.
DkVer	External device connection terminal Connected device version information	When these tags are transmitted from the printer, the data for tag DkMdl is also transmitted.

## **ESC GS J pL pH fn [parameter]**

[Name] Printer information (JSON format) control

[Code] ASCII      ESC    GS    J    pL   pH   fn   [parameter]  
 Hex.            1B    1D    4A   pL   pH   fn   [parameter]  
 Decimal        27    29    74   pL   pH   fn   [parameter]

[Function] Controls printer information (JSON format).  
 • pL and pH specify the parameter count (pL+pH×256) in bytes after fn.  
 • For [parameter], see the function specifications.

fn	Function No.	Function name
48	Function 48	Send log information
49	Function 49	Clear log information



## <Function 48> ESC GS J pL pH fn d1 d2

[Name] Send log information

[Code]	ASCII	ESC	GS	J	pL	pH	fn	d1	d2
	Hex.	1B	1D	4A	pL	pH	fn	d1	d2
	Decimal	27	29	74	pL	pH	fn	d1	d2

[Defined Area] pL = 3, pH = 0  
 fn = 48  
 $0 \leq d1 \leq 1$   
 d2 = 0

[Function] Sends subject log information in JSON format.

[Details] The subject log information is sent in the format below.  
 ESC GS J p1 p2 p3 p4 fn j1 j2 ... jk  
 When sending, p1, p2, p3, and p4 indicate the number of transmission bytes after fn.

d1	Control content
0	Send all log data
1	Send interface information log data

When values outside the defined range for each are set in d1 and d2, information is sent in the format below.

ESC GS J 1 0 0 0 fn (fn = 48)

## <Function 49> ESC GS J pL pH fn m d1 d2 d3

[Name] Clear log information

[Code] ASCII    ESC  GS    J  pL  pH  fn  m  d1  d2  d3  
 Hex.        1B  1D  4A  pL  pH  fn  m  d1  d2  d3  
 Decimal     27  29  74  pL  pH  fn  m  d1  d2  d3

[Defined Area]    pL = 5, pH = 0  
                   fn = 49  
                    $0 \leq m \leq 1$   
                   d1 = 67('C') , d2 = 76('L'), d3 = 82('R')

[Function]        Clears subject log information.

[Details]         The subject log information is cleared.

m	Control content
0	Clear all log data
1	Clear interface information log data

After this command is received, logs are not saved until the power is turned off and on again.

### 2.3.21. Print Settings

#### **ESC RS A n**

[Name] Print area setting

[Code]	ASCII	ESC	RS	A	n
	Hex.	1B	1E	41	n
	Decimal	27	30	65	n

[Defined Area]  $0 \leq n \leq 255$

[Initial Value] Memory switch / Star Configuration setting

[Function] Sets the print area according to n.

Set n to be the same as the print area setting in the memory switch.

For the print area selected with n, refer to the product specifications of that printer or to "Appendix 10 Print Area Setting".

When this command is processed, if print data that has not been printed exists in the image buffer, printing is performed first, and then the print area is set.

When this command is processed, if printing is being performed, the printer waits for a stoppage of printing, and then the print area is set.

The settings related to horizontal position described below are initialized.

- Left margin
- Right margin
- Current position

This command setting will not be initialized by the ESC @ command.

This command setting is initialized by a printer reset.

"n" of this command is the same as with the memory switch. However, caution is necessary because not all print areas described in the memory switch are guaranteed with the product.

Transmission example of this command (Because the horizontal position related settings are initialized by this command, after sending this command, settings must be performed.)

ESC @ → Print area setting command → Each setting command → Print data

This command is disabled in page mode.

## ESC RS d n

[Name]	Set print density				
[Code]	ASCII	ESC	RS	d	n
	Hex.	1B	1E	64	n
	Decimal	27	30	100	n

[Defined Area]	Spec. 1	$0 \leq n \leq 6$	$48 \leq n \leq 54$	("0" ≤ n ≤ "6")
	Spec. 2	$0 \leq n \leq 3$	$48 \leq n \leq 51$	("0" ≤ n ≤ "3")
	Spec. 3	$0 \leq n \leq 3$	$48 \leq n \leq 51$	("0" ≤ n ≤ "3")
	Spec. 4	$0 \leq n \leq 2$	$48 \leq n \leq 50$	("0" ≤ n ≤ "2")
	Spec. 5	$0 \leq n \leq 7$	$48 \leq n \leq 55$	("0" ≤ n ≤ "7")

[Initial Value] Memory switch / Star Configuration setting

[Function] Sets print density.

This command executes after stopping the printing operation.

When in 2-color mode, only print density for red printing can be set by this command.

Spec. 1

n	Single Color Printing Mode	2-color Printing Mode Red Print Density *1
0, 48	Print density + 3	–
1, 49	Print density + 2	–
2, 50	Print density + 1	–
3, 51	Standard print density (Standard)	–
4, 52	Print density - 1	–
5, 53	Print density - 2	–
6, 54	Print density - 3	–

Spec. 2

n	Single Color Printing Mode	2-color Printing Mode Red Print Density *1
0, 48	Print density + 3	–
1, 49	Print density + 2	–
2, 50	Print density + 1	–
3, 51	Standard print density (Standard)	–

Spec. 3

n	Single Color Printing Mode	2-color Printing Mode Red Print Density *1
0, 48	Medium	–
1, 49	Low	–
2, 50	High	–
3, 51	Special	–

Spec. 4

n	Single Color Printing Mode	2-color Printing Mode Red Print Density *1
0, 48	Medium	–
1, 49	Low	–
2, 50	High	–

Spec. 5

n	Single Color Printing Mode
0, 48	Print density + 3
1, 49	Print density + 2
2, 50	Print density + 1
3, 51	Standard print density (Standard)
4, 52	Print density - 1
5, 53	Print density - 2
6, 54	Print density - 3
7, 55	Print density +4

\*1) See the appropriate printer specifications manual for details on the print modes that are available.

## ESC RS r n

[Name] Set print speed

[Code] ASCII ESC RS r n  
 Hex. 1B 1E 72 n  
 Decimal 27 30 114 n

[Defined Area] Spec. 1  $0 \leq n \leq 2$   $48 \leq n \leq 50$  ("0"  $\leq n \leq$  "2")  
 Spec. 2  $n=0, 2$   $n=48, 50$  ( $n="0", "2"$ )  
 Spec. 3  $0 \leq n \leq 2$   $48 \leq n \leq 50$  ("0"  $\leq n \leq$  "2")

[Initial Value] Memory switch / Star Configuration setting

[Function] Sets print speed.  
 This command stops printing to be executed.  
 Because two-color print mode print in one speed, the speed settings with this command are invalid.  
 This command setting becomes valid when returned from the two-color print mode to the single color print mode.  
 Invalid in page mode.

Spec. 1

n	Single Color Printing Mode	2-color Printing Mode *1
0, 48	High speed	–
1, 49	Mid-speed	–
2, 50	Low speed	–

Spec. 2

n	Single Color Printing Mode	2-color Printing Mode *1
0, 48	High speed	–
1, 49	–	–
2, 50	Low speed	–

Spec. 3

n	Single Color Printing Mode	2-color Printing Mode *1
0, 48	Medium	–
1, 49	Low	–
2, 50	High	–

\*1) See the appropriate printer specifications manual for details on the print modes that are available.

### 2.3.22. Special Command

#### **ESC RS R n**

[Name] Selects the special location of use  
 [Code] ASCII ESC RS R n  
 Hex. 1B 1E 52 n  
 Decimal 27 30 82 n

[Defined Area]  $0 \leq n \leq 7$

[Initial Value] Memory switch / Star Configuration setting

[Function] Select the special location of use.

This command is enabled only when at the top of the line.

Set the printer to its default settings by this command.

If choose destination that is currently selected, executes initialization of various settings.

The printer reset or initialize-command initializes the setting of this command.

Invalid in page mode.

n	location of use	Changes from the standard	Note
0	Standard	-	-
1	Thai	- Thai precomposed characters are supported. - ANK fonts specialized for Thai are selected. - The baseline for Thai is adopted.	The below settings are invalid Page mode, International characters, slash 0 and large font
2	(Reserved)		
3	(Reserved)		
4	(Reserved)		
5	(Reserved)		
6	(Reserved)		
7	(Reserved)		

#### **ESC GS m p k n**

[Name] Cleaning notification / parts replacement notification control  
 [Code] ASCII ESC GS m p k n  
 Hex. 1B 1D 6D p k n  
 Decimal 27 29 109 p K n

[Defined Area]  $p=0$   
 $0 \leq k \leq 1$   
 $n=0$

[Initial Value] - - -

[Function] Controls the cleaning notification and parts replacement notification.

• p specifies the subject part.

p	Subject part
0	All

• k specifies the subject notification type.

k	Subject notification type
0	Cleaning notification
1	Parts replacement notification

• n specifies the control content.

n	Control content
0	Cancel notification

### 2.3.23. UTF Command

#### **ESC GS ) U pL pH fn [parameter]**

[Name]	Set Unicode								
[Code]	ASCII	ESC	GS	)	U	pL	pH	fn	[parameter]
	Hex.	1B	1D	29	55	pL	pH	fn	[parameter]
	Decimal	27	29	41	85	pL	pH	fn	[parameter]

[Function] Runs processes related to Unicode.  
 •pL and pH specify the parameter count (pL + pH x 256) in bytes after fn.  
 •See the function specifications for details on [parameter].

Fn	Function No.	Function Name
48	Function 48	Select UTF Code
64	Function 64	Set 1byte priority or 2byte priority
65	Function 65	Set the UTF8 CJK Unified Ideograph font

#### **<Function 48> ESC GS ) U pL pH fn m (fn=48)**

[Name]	Select UTF Code								
[Code]	ASCII	ESC	GS	)	U	pL	pH	fn	m
	Hex.	1B	1D	29	55	pL	pH	fn	m
	Decimal	27	29	41	85	pL	pH	fn	m

[Defined range] pL = 2, pH = 0  
 fn = 48  
 m = 0, 1

[Initial Value] Invalid (At the time of shipment: m = 0)

[Function] Select UTF Code

m	Function Name
0	Invalid
1	UTF8 Valid

When the UTF is valid, code page characters and Kanji characters are specified by the selected UTF code. Only Kanji character types which are installed on the printer and selected can be printed by the UTF code.

## <Function 64> ESC GS ) U pL pH fn m (fn=64)

[Name] Setting of the Unicode ambiguous character

[Code]	ASCII	ESC	GS	)	U	pL	pH	fn	m
	Hex.	1B	1D	29	55	pL	pH	fn	m
	Decimal	27	29	41	85	pL	pH	fn	m

[Defined range] pL = 2, pH = 0  
fn = 64  
m = 0, 1

[Initial Value] Spec. 1 : m = 0  
Spec. 2 : According to setting of memory switch / Star Configuration (Specification for the location of use (SBCS / MBCS))  
MSW0-4=0: m=0  
MSW0-4=1: m=1

[Function] Specifies the 1byte or 2byte priority for ambiguous width characters (1byte/2byte) of Unicode.

m	Function Name
0	1 byte priority
1	2 byte priority



## <Function 65> ESC GS ) U pL pH fn n1 n2 n3 n4 (fn=65)

[Name] Set the UTF-8 CJK Unified Ideograph font  
 [Code] ASCII ESC GS ) U pL pH fn n1 n2 n3 n4  
 Hex. 1B 1D 29 55 pL pH fn n1 n2 n3 n4  
 Decimal 27 29 41 85 pL pH fn n1 n2 n3 n4

[Defined range] pL = 5, pH = 0  
 fn = 65  
 $0 \leq n1, n2, n3, n4 \leq 4$

[Initial Value] Memory switch / Star Configuration.  
 MSW0-8 to 0-A (multi-byte character setting) / configurations[<num>].character.character\_code  
 0-8~0-A (Multi-byte character setting)

Memory Switch / Star Configuration Setting*				Initial Value of parameter				Priority Order
MSW0-A	MSW0-9	MSW0-8	Multi-byte character	n1	n2	n3	n4	
0	0	0	Simplified Chinese	2	3	1	4	Simplified Chinese →Traditional Chinese →Japanese language characters →Hangeul language
0	0	1	Japanese language characters	1	2	3	4	Japanese language characters →Simplified Chinese →Traditional Chinese →Hangeul language
0	1	0	Traditional Chinese (BIG5)	3	2	1	4	Traditional Chinese →Simplified Chinese →Japanese language characters →Hangeul language

\* For the multi-byte character setting with Star Configuration, refer to the Star Configuration Format Specifications.

[Function] Set the font for the output language for Unicode CJK Unified Ideographs.  
 Set the font language for parameter n1 from the following table.  
 If the character to be output is not in the font specified in n1, then the next parameter which specifies a font that possesses the character will be used, in order of preference.  
 If the character does not exist in any of the specified fonts, then a dummy “·” character will be used.

However, if n1, n2, n3, and n4 are all set to 0, then the characters will be output according to the default language preferences.

N	Output font
0	None
1	Japanese language characters
2	Simplified Chinese
3	Traditional Chinese
4	Hangeul language

Example 1) Parameter settings for output using the following language preferences: Japanese → Simplified Chinese → Traditional Chinese → Hangul  
 n1 = 1, n2 = 2, n3 = 3, n4 = 4

Example 2) Parameter setting when outputting only Japanese kanji.  
 n1 = 1, n2 = 0, n3 = 0, n4 = 0

The following is an example of how this command can be used in print.

Print Example) Printing multiple languages in one line, starting with “受付票”.



Transmit the command before each word and change the language to specify

Japanese for "受付票", Simplified Chinese for "验收滑", Traditional Chinese for "驗收滑", and Hangul for "접수 표".

Specifically, the n parameters of this command are sent to the printer with the values and positions shown in examples ① through ⑤ below.

Print Data 「①受付票②验收滑③驗收滑④접수 표⑤<LF>」

- ① n1 = 1, n2 = 0, n3 = 0, n4 = 0 : To output Japanese only
- ② n1 = 2, n2 = 0, n3 = 0, n4 = 0 : To output Simplified Chinese only
- ③ n1 = 3, n2 = 0, n3 = 0, n4 = 0 : To output Traditional Chinese only
- ④ n1 = 4, n2 = 0, n3 = 0, n4 = 0 : Hangul only
- ⑤ n1 = 1, n2 = 0, n3 = 0, n4 = 0 : To output Japanese only (\*Japanese is specified because we want to print the following characters in that language)

Printing results

受付票 验收滑 驗收滑 접수 표

If the command is not transmitted when changing the font.

Print Example 2) Print Data 「①受付票 验收滑 驗收滑 접수 표 <LF>」

- ① n1 = 1, n2 = 2, n3 = 3, n4 = 4 : Japanese → Simplified Chinese → Traditional Chinese → Hangul

Printing results

受付票 验收滑 驗收滑 접수 표

Except for the Hangul characters and “驗”, all characters are output using the highest preference, Japanese (Gothic). In order for the font to be consistent within each word, the highest preference must be specified for each location where the language changes, as shown in Sending Example 1.

### 2.3.24. Black Mark Related Command Details

The following commands control top of form functions using black mark paper.  
 The following commands are effective only when black mark is set to be effective.

#### **ESC d n**

[Name] Auto cutter  
 [Code] ASCII ESC d n  
 Hex. 1B 64 n  
 Decimal 27 100 n

[Defined Area]  $0 \leq d \leq 3$   
 $48 \leq d \leq 51$  ("0"  $\leq d \leq$  "3")  
 n = 116 ("t")

[Initial Value] - - -

[Function] Executes the auto-cutter.  
 After auto-cutter is executed, the printer considers that to be the top of the page.

n	Auto cutter
0, 48	Full cut at the current position. If there is print data remaining in the line buffer, printing of line buffer is executed before the operation described above.
1, 49	Partial cut at the current position. If there is print data remaining in the line buffer, printing of line buffer is executed before the operation described above.
2, 50	After executing top of form, paper is fed to cutting position, then a full cut. Print data in line buffer is printed before the operation described above.
3, 51	After executing top of form, paper is fed to cutting position, then a partial cut. Print data in line buffer is printed before the operation described above.
116	After executing top of form, feed paper to the tear bar position. If there is print data remaining in the line buffer, printing of line buffer is executed before the operation described above.

- (\*) The auto-cutter function operates in the following ways on models that only have a full cut or a partial cut.
- Models that perform only a full cut : Executes a full cut when for instructions calling for a partial cut.
  - Models that perform only a partial cut : Executes a partial cut when there are for instructions calling for a full cut.
- (\*) The printer which is not equipped with an auto-cutter works in the following ways.
- Command for full cut at the current position : Executes printing
  - Command for feeding paper to cutting position : Executes printing and feeds paper to the tear bar position.

## **FF**

[Name] Execute top of form  
 [Code] ASCII FF  
 Hex. 0C  
 Decimal 12

[Defined Area] ---  
 [Initial Value] ---  
 [Function] Executes top of form.

## **ESC C n**

[Name] Set page length to n lines  
 [Code] ASCII ESC C n  
 Hex. 1B 43 n  
 Decimal 27 67 n

[Defined Area]  $1 \leq n \leq 127$   
 [Initial Value] (Form feed amount initial value x 42)  
 [Function] When black mark is effective, this command is ignored.

## **ESC C NUL n**

[Name] Set page length to n x 24 mm units  
 [Code] ASCII ESC C NUL n  
 Hex. 1B 43 0 n  
 Decimal 27 67 0 n

[Defined Area]  $1 \leq n \leq 22$   
 [Initial Value] (Form feed amount initial value x 42)  
 [Function] When black mark is effective, this command is ignored.

### 2.3.25. Color Printing Command Details

The following commands control 2 color printing functions.

The following commands are effective only when using a model handling 2 color printing.

#### **ESC RS c n**

[Name]	Set print color in 2 color print mode				
[Code]	ASCII	ESC	RS	c	n
	Hex.	1B	1E	63	n
	Decimal	27	30	99	n

[Defined Area]  $0 \leq n \leq 1$

$48 \leq n \leq 49$  ("0"  $\leq n \leq$  "1")

[Initial Value] n = 0, 48 (When in 2 color print mode)

[Function] Specifies print color in 2 color print mode.

This command is ignored when not in the 2 color print mode.

Specifies black for the print color when in 2 color print mode.

This command is cleared only when the printer is reset.

The specification of this command is not cleared by ESC @.

However, print color is initialized to black by the ESC @ only when in the compatible 2 color print mode.

n	Specifies 2 color print mode color
0, 48	Black
1, 49	Red

## ESC RS C n

[Name] Select/cancel 2 color print mode  
 [Code] ASCII      ESC RS C n  
           Hex.        1B 1E 43 n  
           Decimal    27 30 67 n

[Defined Area]     $0 \leq n \leq 2$   
                      $48 \leq n \leq 50$  ("0"  $\leq n \leq$  "2")  
 [Initial Value]    n = 0, 48  
 [Function]        Select/cancel 2 color print mode

N	Select/cancel 2 color print mode
0, 48	<p>Cancel 2-color printing mode</p> <p>When in 2-color print mode, the 2-color print mode is canceled by this command.</p> <p>This command is ignored when the 2-color print mode is already cancelled.</p> <p>The specification of this command is not cleared by ESC @.</p> <p>The following processes are executed by canceling the 2-color print mode using this command.</p> <ul style="list-style-type: none"> <li>• Prints data in line buffer in 2-color print mode, if unprinted data exists in the line buffer.</li> <li>• Waits to stop printing when printing in 2-color print mode.</li> <li>• Recovers logo print setting to single color mode setting.</li> </ul>
1, 49	<p>Select 2-color printing mode</p> <p>When in single color print mode, the 2-color print mode is selected by this command.</p> <p>This command is ignored already in the 2-color print mode.</p> <p>The specification of this command is not cleared by ESC @.</p> <p>The following processes are executed by selecting the 2-color print mode using this command.</p> <ul style="list-style-type: none"> <li>• Prints data in line buffer in the single color print mode, if unprinted data exists in the line buffer.</li> <li>• Waits to stop printing when printing in single-color print mode.</li> <li>• Initializes print color setting (2-color print mode setting)</li> <li>• Sets logo print setting to 2 color mode setting.</li> </ul>

Invalid in page mode.

## **ESC 4**

[Name] Specifying white/black inversion  
 [Code] ASCII ESC 4  
 Hex. 1B 34  
 Decimal 27 52

[Defined Area] - - -

[Initial Value] White/black inversion cancelled

[Function] Specifies white/black inversion for ANK characters and Kanji characters.  
 IBM block ignores white/black inversion.

## **ESC 5**

[Name] Cancellation of white/black inversion  
 [Code] ASCII ESC 5  
 Hex. 1B 35  
 Decimal 27 53

[Defined Area] - - -

[Initial Value] White/black inversion cancelled

[Function] Cancels white/black inversion for ANK characters and Kanji characters.

### 2.3.26. External Device Drive

#### **ESC BEL n1 n2**

[Name] Set external drive device 1 pulse width  
 [Code] ASCII ESC BEL n1 n2  
 Hex. 1B 07 n1 n2  
 Decimal 27 7 n1 n2

[Defined Area]  $1 \leq n1 \leq 127$   
 $1 \leq n2 \leq 127$

[Initial Value]  $n1 = 20$  (Energizing time: 200 msec)  
 $n2 = 20$  (Delay time: 200 msec)

[Function] Sets the energizing and delay times for drive of the external device.  
 - Energizing time =  $10 \times n1$  (ms)  
 - Delay time =  $10 \times n2$  (ms)

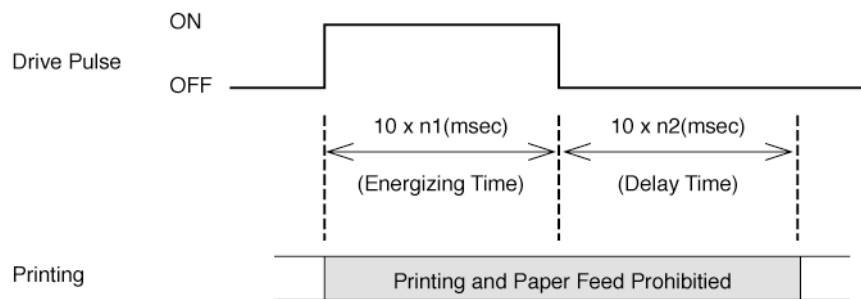

#### [Model limitation]

mPOP: This is handled differently depending on the FW version.

<F/W Ver1.0 to Ver.1.3>

This command is ignored.

<F/W Ver.2.0 or later>

- If the hardware supports DK ports, this command is set as the drive condition of the external drawer.
- If the hardware does not support DK ports, this command is ignored.



## BEL

[Name] External device 1 drive instruction  
 [Code] ASCII BEL  
 Hex. 07  
 Decimal 7

[Defined Area] ---

[Initial Value] ---

[Function] Executes the external device drive conditions set according to the command to set the external drive device pulse width (ESC BEL n1 n2).  
 As with other commands, it temporarily stores data in the data buffer, then executes in the order received.  
 External device 1 and external device 2 cannot be executed simultaneously.  
 For the additional specifications when a melody speaker is connected, refer to Appendix 9.  
 For the melody speaker specifications, refer to the melody speaker product specifications.

[Model limitation]

mPOP : This is handled differently depending on the FW version.

<F/W Ver1.0 to Ver.1.3>

The internal drawer is driven by this command.

<F/W Ver.2.0 or later>

- If the hardware supports DK ports, drawers (internal/external) subject to driving follow the memory switch settings.
- If the hardware does not support DK ports, the internal drawer is driven.

## FS

[Name] External device 1 drive instruction  
 [Code] ASCII FS  
 Hex. 1C  
 Decimal 28

[Defined Area] ---

[Initial Value] ---

[Function] Executes the external device drive conditions set according to the command to set the external drive device pulse width (ESC BEL n1 n2).  
 As with other commands, it temporarily stores data in the data buffer, then executes in the order received.  
 External device 1 and external device 2 cannot be executed simultaneously.  
 For the additional specifications when a melody speaker is connected, refer to Appendix 9.  
 For the melody speaker specifications, refer to the melody speaker product specifications.

[Model limitation]

mPOP : This is handled differently depending on the FW version.

<F/W Ver1.0 to Ver.1.3>

The internal drawer is driven by this command.

<F/W Ver.2.0 or later>

- If the hardware supports DK ports, drawers (internal/external) subject to driving follow the memory switch settings.
- If the hardware does not support DK ports, the internal drawer is driven.

## SUB

[Name] External device 2 drive instruction  
 [Code] ASCII SUB  
 Hex. 1A  
 Decimal 26

[Defined Area] - - -

[Initial Value] - - -

[Function] Drives external device 2.  
 The energizing time and delay time for the external device 2 are fixed at 200 ms each.  
 As with other commands, it temporarily stores data in the data buffer, then executes in the order received.  
 External device 1 and external device 2 cannot be executed simultaneously.  
 For the additional specifications when a melody speaker is connected, refer to Appendix 9.  
 For the melody speaker specifications, refer to the melody speaker product specifications.

[Model limitation]

mPOP : This is handled differently depending on the FW version.

<F/W Ver1.0 to Ver.1.3>

This command is ignored.

<F/W Ver.2.0 or later>

- If the hardware supports DK ports, drawers (internal/external) subject to driving follow the memory switch settings.

When the external drawer is driven, it applies the drive setting conditions from the setting command (ESC BEL n1 n2) of the external drive device pulse width.

- If the hardware does not support DK ports, this command is ignored.

## EM

[Name] External device 2 drive instruction  
 [Code] ASCII EM  
 Hex. 19  
 Decimal 25

[Defined Area] - - -

[Initial Value] - - -

[Function] Drives external device 2.  
 The energizing time and delay time for the external device 2 are fixed at 200 ms each.  
 As with other commands, it temporarily stores data in the data buffer, then executes in the order received.  
 External device 1 and external device 2 cannot be executed simultaneously.  
 For the additional specifications when a melody speaker is connected, refer to Appendix 9.  
 For the melody speaker specifications, refer to the melody speaker product specifications.

[Model limitation]

mPOP: This is handled differently depending on the FW version.

<F/W Ver1.0 to Ver.1.3>

This command is ignored.

<F/W Ver.2.0 or later>

- If the hardware supports DK ports, drawers (internal/external) subject to driving follow the memory switch settings.

When the external drawer is driven, it applies the drive setting conditions from the setting command (ESC BEL n1 n2) of the external drive device pulse width.

- If the hardware does not support DK ports, this command is ignored.

## ESC GS EM DC1 m n1 n2

[Name] External buzzer drive pulse condition settings  
 [Code] ASCII ESC GS EM DC1 m n1 n2  
 Hex. 1B 1D 19 11 m n1 n2  
 Decimal 27 29 25 17 m n1 n2

[Defined Area]  $1 \leq m \leq 2$   $49 \leq m \leq 50$

$0 \leq n1 \leq 255$

$0 \leq n2 \leq 255$

[Initial Value] n1=0, n2=0

[Function] Sets external buzzer derive pulse condition.  
 m specifies the buzzer drive terminal to perform the condition settings.

m	Buzzer Drive Terminal
1, 49	Buzzer Drive Terminal 1
2, 50	Buzzer Drive Terminal 2

n1 specifies the energizing time; n2 specifies the delay time.

- Energizing time: = 20msec x n1

- Delay time: = 20msec x n2

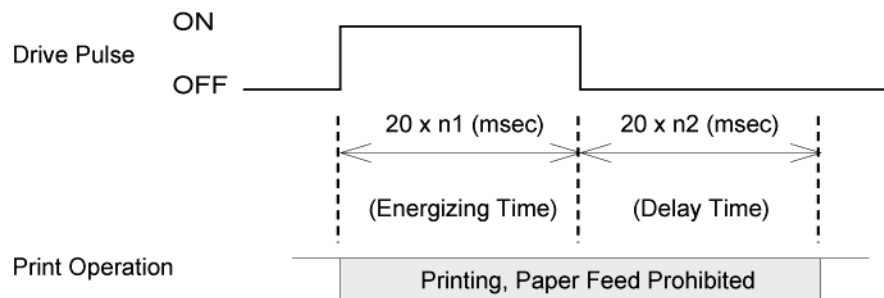

Drives for external buzzers set using this command is performed by <ESC> <GS> <EM> <DC2> m n1 n2.

The setting value is not initialized by <ESC> “@”.

## ESC GS EM DC2 m n1 n2

[Name] External buzzer drive execution

[Code] ASCII ESC GS EM DC2 m n1 n2  
 Hex. 1B 1D 19 12 m n1 n2  
 Decimal 27 29 25 18 m n1 n2

[Defined Area]  $1 \leq m \leq 2, 49 \leq m \leq 50$   
 $1 \leq n1 \leq 20$   
 $n2=0$

[Initial Value] ---

[Function] Repeatedly drives the buzzer according to the ON/OFF conditions set by the external buzzer drive pulse conditions command <ESC> <GS> <EM> <DC1> m n1 n2.  
 m specifies the buzzer drive terminal to drive.

m	Buzzer Drive Terminal
1, 49	Buzzer Drive Terminal 1
2, 50	Buzzer Drive Terminal 2

Specifies the number of repetitions of the buzzer drive with  $(n2 \times 256 + n1)$ .

The buzzer will not ring while printing.

This command is prohibited for uses other than to ring the buzzer.

(If this command is used to drive the cash drawer on models that have an external device terminal, the system will be damaged.)

**The buzzer can be stopped by pressing the paper feed switch or opening the cover when it is ringing.**

Example:

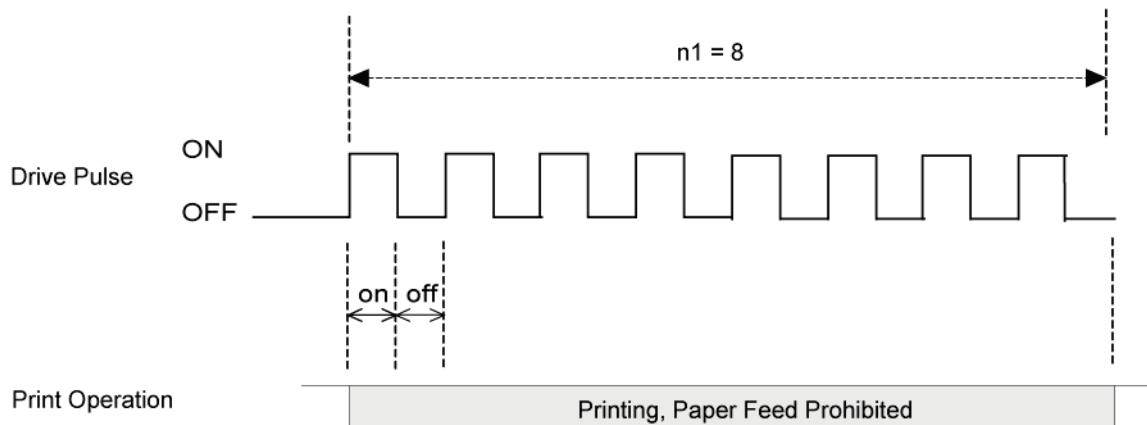

(Note) If the off time is set to 0 (zero), it is possible to ring the buzzer continuously for the amount of n1. For example, if on = 5 seconds, off = 0, and n1 = 20 times, the buzzer will ring for 100 seconds.

For the additional specifications when a melody speaker is connected, refer to Appendix 9.  
 For the melody speaker specifications, refer to the melody speaker product specifications.

### 2.3.27. Melody Speaker Commands

#### **ESC GS s R z n k1 k2 k3 d1...dk**

[Name]	Playback of received data												
[Code]	ASCII	ESC	GS	s	R	z	n	k1	k2	k3	d1	...	dk
	Hex.	1B	1D	73	52	z	n	k1	k2	k3	d1	...	dk
	Decimal	27	29	115	82	z	n	k1	k2	k3	d1	...	dk

[Defined Area]	$1 \leq z \leq 2$
	$0 \leq n \leq 15, n=255$
	$1 \leq (k=k1+k2 \times 256+k3 \times 65536) \leq 128000$
	$0 \leq d \leq 255$

[Initial Value] - - -

[Function]

If melody speaker playback is in progress when processing of this command is started, playback for this command is started after the playback in progress ends.

The sound data is played once as it is received and is not registered in nonvolatile memory.

z specifies the sampling frequency and number of quantizing bits of the sound data for playback.

The maximum number of seconds of the sound data that can be played varies depending on the sampling frequency and number of quantizing bits of the sound data for playback.

z	Sampling frequency	Quantizing bits	Maximum number of seconds that can be registered
1	12.8kHz	8bit	10 sec
2	12.8kHz	16bit	5 sec

n specifies the sound volume for playback.

n	volume
0	OFF
1	-27.31dB
2	-17.44dB
3	-12.94dB
4	-9.99dB
5	-7.79dB
6	-6.04dB
7	-4.58dB
8	-3.34dB
9	-2.25dB
10	-1.28dB
11	-0.41dB
12	0.00dB
13	+1.45dB
14	+2.40dB
15	+2.98dB
255	Determined by melody speaker DSW2 setting.

The number of sound data bytes is specified by  $k1 + k2 \times 256 + k3 \times 65536$ .

d is PCM format sound data with a monaural code and the sampling frequency and number of quantizing bits specified by z.

The maximum size that can be played is 128000 bytes.

This command is ignored if the melody speaker is not connected when the printer power is turned on.

Use of this command when a drawer is connected to the external device connection terminal is prohibited because it may damage the drawer.

### 2.3.28. Barcode Reader Command

#### Barcode reader which corresponds

See each printer's product specifications manual

#### ESC GS B 0

[Name]	Send data to a barcode reader									
[Code]	ASCII	ESC	GS	B	0	n1	n2	d1	...	dk
	Hex.	1B	1D	42	30	n1	n2	d1	...	dk
	Decimal	27	29	66	48	n1	n2	d1	...	dk
[Defined Area]	n1+n2x256 : BYTE count (1≤d≤65535)									
	K : n1+ n2x256									
[Initial Value]	---									
[Function]	The serial command is sent to a barcode reader.									

#### ESC GS B 1

[Name]	Status request				
[Code]	ASCII	ESC	GS	B	1
	Hex.	1B	1D	42	31
	Decimal	27	29	66	49
[Defined Area]	---				
[Initial Value]	---				
[Function]	Receives the printer status				

The barcode data transmission format from the printer  
 <ESC> <GS> B 1 n

Bit (n)	Status
0	0: No data in barcode buffer
	1: Data exists in barcode buffer
1	0: No connection of barcode reader
	1: Barcode reader is connected to the printer
2 - 7	Reserved

## ESC GS B 2

[Name]	Barcode data request				
[Code]	ASCII	ESC	GS	B	2
	Hex.	1B	1D	42	32
	Decimal	27	29	66	50

[Defined Area] ---

[Initial Value] ---

[Function] Acquire barcode data or the cereal command from a barcode reader.

The barcode data transmission format from the printer

<ESC><GS> B 2 n1 n2 d1...dk

n1+n2x256 : BYTE count ( $1 \leq d \leq 65535$ )

k : n1 + n2 x 256

## ESC GS B 3

[Name]	Buffer clear				
[Code]	ASCII	ESC	GS	B	3
	Hex.	1B	1D	42	33
	Decimal	27	29	66	51

[Defined Area] ---

[Initial Value] ---

[Function] A barcode buffer of a printer is cleared.



### 2.3.29. Magnetic Card Reader Commands

#### Applicable Magnetic Card Readers

Refer to the printer's specification manuals.

Refer to Appendix 8 Specifications of Magnetic Cards for the readable formats.

#### ESC M C

[Name] Read ISO track  
 [Code] ASCII       ESC   M   C  
           Hex.        1B  4D  43  
           Decimal    27  77  67

[Function]       Reads track data.

[Note]            The printer waits to read a card.  
                   When reading is successful, the printer sends data to the host and exits the MSR mode.

#### ESC M D

[Name] Read ISO track  
 [Code] ASCII       ESC   M   D  
           Hex.        1B  4D  44  
           Decimal    27  77  68

[Function]       Reads track data.

[Note]            The printer waits to read a card.  
                   When reading is successful, the printer sends data to the host and exits the MSR mode.

#### ESC M E

[Name] Read ISO 2 tracks  
 [Code] ASCII       ESC   M   E  
           Hex.        1B  4D  45  
           Decimal    27  77  69

[Function]       Reads data of 2 tracks simultaneously.

[Note]            The printer waits to read a card.  
                   When reading is successful, the printer sends data to the host and exits the MSR mode.

## **ESC M F**

[Name] Read ISO 3 tracks  
 [Code] ASCII       ESC   M   F  
           Hex.        1B  4D  46  
           Decimal    27  77  70

[Function]        Reads data of 3 tracks simultaneously.

[Note]            The printer waits to read a card.

When reading is successful, the printer sends data to the host and exits the MSR mode.

## **ESC M G**

[Name] Read ISO track 3  
 [Code] ASCII       ESC   M   G  
           Hex.        1B  4D  47  
           Decimal    27  77  71

[Function]        Reads data of ISO track 3

[Note]            The printer waits to read a card.

When reading is successful, the printer sends data to the host and exits the MSR mode.

## **ESC M J**

[Name] Read JIS-II track  
 [Code] ASCII       ESC   M   J  
           Hex.        1B  4D  4A  
           Decimal    27  77  74

[Function]        Reads data of JIS-II (JIS) cards

[Note]            The printer waits to read a card.

When reading is successful, the printer sends data to the host and exits the MSR mode.

## **EOT**

[Name] Cancel MSR mode  
 [Code] ASCII       EOT  
           Hex.        04  
           Decimal    4

[Function]        Stops reading and exits the MSR mode.

### 2.3.30. Customer display Commands

#### Applicable Customer display

Refer to the printer's specification manuals.

#### **ESC GS B @**

[Name] Send data to a customer display  
 [Code] ASCII        ESC GS B @    n1 n2 d1 ... dk  
          Hex.        1B 1D 42 40    n1 n2 d1 ... dk  
          Decimal    27 29 66 64    n1 n2 d1 ... dk

[Defined Area]    n1+n2x256 : BYTE count ( $1 \leq d \leq 65535$ )  
                   k                : n1+ n2x256

[Initial Value]    - - -

[Function]        The customer display command is sent to a customer display.

#### **ESC RS B A**

[Name] Status request  
 [Code] ASCII        ESC RS B A  
          Hex.        1B 1E 42 41  
          Decimal    27 30 66 65

[Defined Area]    - - -

[Initial Value]    - - -

[Function]        Receives the printer status

The customer display status transmission format from the printer  
 <ESC> <RS> B A n

Bit (n)	Status
0	0: No data in customer display buffer
	1: Data exists in customer display buffer
1	0: No connection of customer display
	1: Customer display is connected to the printer
2 to 7	Reserved

### ESC GS B B

[Name]	Customer display data request				
[Code]	ASCII	ESC	GS	B	B
	Hex.	1B	1D	42	42
	Decimal	27	29	66	66

[Defined Area] ---

[Initial Value] ---

[Function] Acquire customer display data from a customer display.

The customer display data transmission format from the printer  
 <ESC><GS> B B n1 n2 d1...dk

n1+n2x256 : BYTE count ( $1 \leq d \leq 65535$ )  
 k : n1 + n2 x 256

### ESC GS B C

[Name]	Buffer clear				
[Code]	ASCII	ESC	GS	B	C
	Hex.	1B	1D	42	43
	Decimal	27	29	66	67

[Defined Area] ---

[Initial Value] ---

[Function] A customer display buffer of a printer is cleared.

### 2.3.31. Network Commands

#### **ESC GS ) N pL pH fn [parameter]**

[Name] Set network parameters  
 [Code] ASCII ESC ) N pL pH fn [parameter]  
 Hex. 1B 29 4E pL pH fn [parameter]  
 Decimal 27 41 78 pL pH fn [parameter]

[Function] Executes actions related to the network parameter.  
 - With "pL" and "pH", the parameter count after "fn" is specified to (pL + pH × 256) bytes.  
 - For [parameter], see the specification by function.

Some functions require login, and some require login password change.

fn	Code	Function	Login	Login password change
48	ESC GS ) N pL pH fn m n	Set acquisition method for IP address	Not necessary	Not necessary
49	ESC GS ) N pL pH fn m d1 d2 d3 d4	Set IP Address	Not necessary	Not necessary
50	ESC GS ) N pL pH fn m d1 d2 d3 d4	Set subnet mask	Not necessary	Not necessary
51	ESC GS ) N pL pH fn m d1 d2 d3 d4	Set default gateway	Not necessary	Not necessary
52	ESC GS ) N pL pH fn m n	Set DHCP Timeout	Not necessary	Not necessary
53	ESC GS ) N pL pH fn m n	Set 9100 Multi Session	Not necessary	Not necessary
54	ESC GS ) N pL pH fn m n1 n2	Set 9100 Data Timeout	Not necessary	Not necessary
55	ESC GS ) N pL pH fn m n	Set disconnect Message	Not necessary	Not necessary
57	ESC GS ) N pL pH fn m n	Set SteadyLAN	Not necessary	Not necessary
58	ESC GS ) N pL pH fn m d1 d2 d3 d4	Set DNS 1	Necessary	Necessary
59	ESC GS ) N pL pH fn m d1 d2 d3 d4	Set DNS 2	Necessary	Necessary
64	ESC GS ) N pL pH fn m	Transmit acquisition method for IP address	Not necessary	Not necessary
65	ESC GS ) N pL pH fn m	Send IP Address	Not necessary	Not necessary
66	ESC GS ) N pL pH fn m	Send subnet mask	Not necessary	Not necessary
67	ESC GS ) N pL pH fn m	Send default gateway	Not necessary	Not necessary
68	ESC GS ) N pL pH fn m	Send DHCPTimeout	Not necessary	Not necessary
69	ESC GS ) N pL pH fn m	Send 9100 Multi Session	Not necessary	Not necessary
70	ESC GS ) N pL pH fn m	Send 9100 Data Timeout	Not necessary	Not necessary
71	ESC GS ) N pL pH fn m	Send disconnect Message	Not necessary	Not necessary
73	ESC GS ) N pL pH fn m	Send SteadyLAN	Not necessary	Not necessary
74	ESC GS ) N pL pH fn m	Send DNS 1	Necessary	Necessary
75	ESC GS ) N pL pH fn m	Send DNS 2	Necessary	Necessary
80	ESC GS ) N pL pH fn m n	Set TCP#9100	Not necessary	Not necessary
81	ESC GS ) N pL pH fn m	Send TCP#9100	Not necessary	Not necessary
82	ESC GS ) N pL pH fn m n	Set TCP#9101	Not necessary	Not necessary
83	ESC GS ) N pL pH fn m	Send TCP#9101	Not necessary	Not necessary
84	ESC GS ) N pL pH fn m n	Set LPR	Not necessary	Not necessary
85	ESC GS ) N pL pH fn m	Send LPR	Not necessary	Not necessary
86	ESC GS ) N pL pH fn m n	Set UDP#22222	Not necessary	Not necessary
87	ESC GS ) N pL pH fn m	Send UDP#22222	Not necessary	Not necessary

fn	Code	Function	Login	Login password change
88	ESC GS ) N pL pH fn m n	Set Telnet	Not necessary	Not necessary
89	ESC GS ) N pL pH fn m	Send Telnet	Not necessary	Not necessary
90	ESC GS ) N pL pH fn m n	Set TCP#80	Not necessary	Not necessary
91	ESC GS ) N pL pH fn m	Send TCP#80	Not necessary	Not necessary
92	ESC GS ) N pL pH fn m n	Set TCP#433	Not necessary	Not necessary
93	ESC GS ) N pL pH fn m	Send TCP#433	Not necessary	Not necessary
94	ESC GS ) N pL pH fn m n	Set TCP#22222	Not necessary	Not necessary
95	ESC GS ) N pL pH fn m	Send TCP#22222	Not necessary	Not necessary
112	ESC GS ) N pL pH fn m	Save network parameters	*1	*1
113	ESC GS ) N pL pH fn m	Initialize network parameters	*1	*1
114	ESC GS ) N pL pH fn m d1 ... dk	Execute login	Not necessary	Not necessary
115	ESC GS ) N pL pH fn m	Send login status	Not necessary	Not necessary
116	ESC GS ) N pL pH fn m n	Execute logout	Necessary	Not necessary
128	ESC GS ) N pL pH fn m d1 ... dk	Set login password	Necessary	Not necessary
129	ESC GS ) N pL pH fn m	Send login password change status	Necessary	Not necessary
130	ESC GS ) N pL pH fn m n	Set Star CloudPRNT Cloud Service	Necessary	Necessary
131	ESC GS ) N pL pH fn m	Send Star CloudPRNT Cloud Service	Necessary	Necessary
132	ESC GS ) N pL pH fn m d1 ... dk	Set Star CloudPRNT Service URL	Necessary	Necessary
133	ESC GS ) N pL pH fn m	Send Star CloudPRNT Service URL	Necessary	Necessary
134	ESC GS ) N pL pH fn m n1 n2	Set Star CloudPRNT Polling time	Necessary	Necessary
135	ESC GS ) N pL pH fn m	Send Star CloudPRNT Polling time	Necessary	Necessary
136	ESC GS ) N pL pH fn m d1 ... dk	Set Star CloudPRNT User Name	Necessary	Necessary
137	ESC GS ) N pL pH fn m	Send Star CloudPRNT User Name	Necessary	Necessary
138	ESC GS ) N pL pH fn m d1 ... dk	Set Star CloudPRNT Password	Necessary	Necessary
139	ESC GS ) N pL pH fn m	Send Star CloudPRNT Password	Necessary	Necessary
140	ESC GS ) N pL pH fn m n d1 ... dk	Set Star CloudPRNT TLS trust level	Necessary	Necessary
141	ESC GS ) N pL pH fn m	Send Star CloudPRNT TLS trust level	Necessary	Necessary
142	ESC GS ) N pL pH fn m n d1 ... dk	Set Star CloudPRNT NTP Server	Necessary	Necessary
143	ESC GS ) N pL pH fn m	Set Star CloudPRNT NTP Server	Necessary	Necessary
144	ESC GS ) N pL pH fn m n	Set Star CloudPRNT TLS1.2 Cipher Suite Encryption Level	Necessary	Necessary
145	ESC GS ) N pL pH fn m	Send Star CloudPRNT TLS1.2 Cipher Suite Encryption Level I	Necessary	Necessary
146	ESC GS ) N pL pH fn m n	Set Star CloudPRNT TLS1.3	Necessary	Necessary
147	ESC GS ) N pL pH fn m	Send Star CloudPRNT TLS1.3	Necessary	Necessary
150	ESC GS ) N pL pH fn m d1 ... dk	Decrypt and send strings	Not necessary	Not necessary
151	Reserved			
152	ESC GS ) N pL pH fn m n1 n2	Set Star CloudPRNT HTTP Response Timeout	Necessary	Necessary
153	ESC GS ) N pL pH fn m	Send Star CloudPRNT HTTP Response Timeout	Necessary	Necessary

\*1: For details, refer to the relevant specification for each function.

The following shows an example of actual command transmission.

Example 1: When setting a network parameter that does not require login

fn	Host transmission data	Printer response data	
64	ESC GS ) N 0x02 0x00 0x40 0x01	ESC GS ) N 0x02 0x00 0x40 0x01 0x00 LF NUL	"Sending IP Address Acquisition Method" Send command Setting value of acquisition method of IPAddress. Return "DHCP"
65	ESC GS ) N 0x02 0x00 0x41 0x01	ESC GS ) N 0x02 0x00 0x41 0x01 0x00 0x00 0x00 0x00 LF NUL	"Sending IP Address" Send command IP Address setting value Return "0.0.0.0"
66	ESC GS ) N 0x02 0x00 0x42 0x01	ESC GS ) N 0x02 0x00 0x42 0x01 0x00 0x00 0x00 0x00 LF NUL	"Subnet Mask transmission" Send command Subnet Mask setting value Return "0.0.0.0"
67	ESC GS ) N 0x02 0x00 0x43 0x01	ESC GS ) N 0x02 0x00 0x43 0x01 0x00 0x00 0x00 0x00 LF NUL	"Send Default Gateway" Send command IDefault Gateway settings Return "0.0.0.0"
68	ESC GS ) N 0x02 0x00 0x44 0x01	ESC GS ) N 0x02 0x00 0x44 0x01 0x01 LF NUL	"Send DHCP Timeout" Send command DHCP Timeout setting value Return "Valid"
69	ESC GS ) N 0x02 0x00 0x45 0x01	ESC GS ) N 0x02 0x00 0x45 0x01 0x00 LF NUL	"Sending 9100 Multi Session" Send command 9100 Multi Session setting values Return "Invalid"
70	ESC GS ) N 0x02 0x00 0x46 0x01	ESC GS ) N 0x02 0x00 0x46 0x01 0x00 LF NUL	"Sending 9100 Data Timeout" Send command 9100 Data Timeout setting value Return "0 Sec."
71	ESC GS ) N 0x02 0x00 0x47 0x01	ESC GS ) N 0x02 0x00 0x47 0x01 0x00 LF NUL	"Sending Disconnect Message" Send command Disconnect Message Settings Return "Invalid"
73	ESC GS ) N 0x02 0x00 0x49 0x01	ESC GS ) N 0x02 0x00 0x49 0x01 0x00 LF NUL	"Sending SteadyLAN" Send command Disconnect Message Settings Return "Valid (For iOS)"
48	ESC GS ) N 0x03 0x00 0x30 0x01 0x01		Set IP Address acquisition method to "Static"
49	ESC GS ) N 0x06 0x00 0x31 0x01 0xC0 0xA8 0x01 0x0A		Set IP Address to "192.168.1.10" *1
50	ESC GS ) N 0x06 0x00 0x32 0x01 0xFF 0xFF 0xFF 0x00		Set Subnet Mask to "255.255.255.0" *1
51	ESC GS ) N 0x06 0x00 0x33 0x01 0xC0 0xA8 0x01 0xFE		Set Default Gateway to "192.168.1.254" *1
52	ESC GS ) N 0x03 0x00 0x34 0x01 0x00		Set DHCPTimeout setting to "Invalid"
53	ESC GS ) N 0x03 0x00 0x35 0x01 0x01		Set 9100 Multi Session setting to "Valid"
54	ESC GS ) N 0x03 0x00 0x36 0x01 0x1E 0x00		Set 9100 Data Timeout setting to "30 Sec."
55	ESC GS ) N 0x03 0x00 0x37 0x01 0x01		Set Disconnect Message setting to "Valid"
57	ESC GS ) N 0x03 0x00 0x39 0x01 0x01		Set SteadyLAN setting to "Valid (For iOS)"
112	ESC GS ) N 0x03 0x00 0x70 0x01		Save the above settings *2

Example 2: When setting a network parameter that requires login

fn	Host transmission data	Host transmission data	
114	ESC GS ) N 0x08 0x00 0x72 0x01 0x70 0x75 0x62 0x6C 0x69 0x63		Execute Login Default password "public"
115	ESC GS ) N 0x02 0x00 0x73 0x01	ESC GS ) N 0x02 0x00 0x73 0x01 0x01 LF NUL	"Send Login Status" Send command Return "Logged In"
129	ESC GS ) N 0x02 0x00 0x81 0x01	ESC GS ) N 0x02 0x00 0x81 0x01 0x00 LF NUL	"Send Login Password Change Status" Send command Return "Login Password Not Changed"
128	ESC GS ) N 0x0A 0x00 0x80 0x01 0x61 0x62 0x63 0x64 0x31 0x32 0x33 0x34		Set login password to "abcd1234"
131	ESC GS ) N 0x02 0x00 0x83 0x01	ESC GS ) N 0x02 0x00 0x83 0x01 LF NUL	"Send Star CloudPRNT Cloud Service" Send command Return "(Not Set)"
133	ESC GS ) N 0x02 0x00 0x85 0x01	ESC GS ) N 0x02 0x00 0x85 0x01 LF NUL	"Send Star CloudPRNT Service URL" Send command Return "(Not Set)"
135	ESC GS ) N 0x02 0x00 0x87 0x01	ESC GS ) N 0x02 0x00 0x87 0x01 0x05 0x00 LF NUL	"Send Star CloudPRNT Polling time" Send command Return "5Sec."
137	ESC GS ) N 0x02 0x00 0x89 0x01	ESC GS ) N 0x02 0x00 0x89 0x01 LF NUL	"Send Star CloudPRNT User Name" Send command Return "(Not Set)"
139	ESC GS ) N 0x02 0x00 0x8B 0x01	ESC GS ) N 0x02 0x00 0x8B 0x01 LF NUL	"Send Star CloudPRNT Password" Send command Return "(Not Set)"
141	ESC GS ) N 0x02 0x00 0x8D 0x01	ESC GS ) N 0x02 0x00 0x8D 0x01 0x00 LF NUL	"Send Star CloudPRNT TLS trust level" Send command Return "Use trusted CA-Certificate list"
143	ESC GS ) N 0x02 0x00 0x8F 0x01	ESC GS ) N 0x02 0x00 0x8F 0x01 0x30 0x2E ... 0x72 0x67 LF NUL	"Send Star CloudPRNT NTP Server" Send command Return "0.pool.ntp.org"
130	ESC GS ) N 0x03 0x00 0x82 0x01 0x01		Set Star CloudPRNT Cloud Service to "Enabled"
132	ESC GS ) N 0x09 0x00 0x84 0x01 0x61 0x61 0x61 0x2E 0x63 0x6F 0x6D		Set Star CloudPRNT Service URL to "aaa.com"
134	ESC GS ) N 0x04 0x00 0x86 0x01 0x01 0x01		Set Star CloudPRNT Polling time to "1Sec."
136	ESC GS ) N 0x06 0x00 0x88 0x01 0x75 0x73 0x65 0x72		Set Star CloudPRNT User Name to "user"
138	ESC GS ) N 0x06 0x00 0x8A 0x01 0x70 0x61 0x73 0x73		Set Star CloudPRNT Password to "pass"
140	ESC GS ) N pL pH 0x8C 0x01 0x01 d1 ... dk		Set Star CloudPRNT TLS trust level to "Use custom CA-Certificate"
142	ESC GS ) N 0x09 0x00 0x8E 0x01 0x62 0x62 0x62 0x2E 0x63 0x6F 0x6D		Set Star CloudPRNT NTP Server to "bbb.com"
112	ESC GS ) N 0x03 0x00 0x70 0x01 0x00		Save the above settings.



## <Function 48> ESC GS ) N pL pH fn m n (fn=48)

[Name]	Set network parameters									
[Code]	ASCII	ESC	GS	)	N	pL	pH	fn	m	n
	Hex.	1B	1D	29	4E	pL	pH	fn	m	n
	Decimal	27	29	41	78	pL	pH	fn	m	n
[Defined Area]	pL = 3, pH = 0 fn = 48 m = 1 (Added description) n = 0, 1									
[Initial Value]	n = 0 / Star Configuration setting									
[Function]	Sets the acquisition method for IP address.									
[Details]	"n" specifies the acquisition method for IP address.									

n	IP address acquisition method
0	DHCP
1	Static

When n = 0 is specified, the following settings are initialized.

ESC GS ) N (fn=49)	Set IP address
ESC GS ) N (fn=50)	Set subnet mask
ESC GS ) N (fn=51)	Set default gateway

The setting of this command is stored in the nonvolatile memory by ESC GS ) N (fn=112), and will be reflected to the operation after a hardware reset is executed.

## <Function 49> ESC GS ) N pL pH fn m d1 d2 d3 d4 (fn=49)

[Name]	Set IP Address												
[Code]	ASCII	ESC	GS	)	N	pL	pH	fn	m	d1	d2	d3	d4
	Hex.	1B	1D	29	4E	pL	pH	fn	m	d1	d2	d3	d4
	Decimal	27	29	41	78	pL	pH	fn	m	d1	d2	d3	d4
[Defined Area]	pL = 6, pH = 0 fn = 49 m = 1 0 ≤ d1 ≤ 255, 0 ≤ d2 ≤ 255, 0 ≤ d3 ≤ 255, 0 ≤ d4 ≤ 255 [Initial Value]												
[Initial Value]	d1 = 0, d2 = 0, d3 = 0, d4 = 0 / Star Configuration setting												
[Function]	Set IP Address. d1, d2, d3, and d4 specifies the IP address. Example: When setting the IP address to 192.168.1.10 d1 = 192, d2 = 168, d3 = 1, d4 = 10												

This command becomes valid only when n=1 (Static) is set by ESC GS ) N (fn=48).

The setting of this command is stored in the nonvolatile memory by ESC GS ) N (fn=112), and will be reflected to the operation after a hardware reset is executed.

### <Function 50> ESC GS ) N pL pH fn m d1 d2 d3 d4 (fn=50)

[Name]	Set Subnet Mask												
[Code]	ASCII	ESC	GS	)	N	pL	pH	fn	m	d1	d2	d3	d4
	Hex.	1B	1D	29	4E	pL	pH	fn	m	d1	d2	d3	d4
	Decimal	27	29	41	78	pL	pH	fn	m	d1	d2	d3	d4

[Defined Area] pL = 6, pH = 0  
fn = 50  
m = 1

$0 \leq d1 \leq 255, 0 \leq d2 \leq 255, 0 \leq d3 \leq 255, 0 \leq d4 \leq 255$

[Initial Value] d1 = 0, d2 = 0, d3 = 0, d4 = 0 / Star Configuration setting

[Function] Sets the Subnet Mask

d1, d2, d3, and d4 specifies the Subnet Mask.

Example: When setting the Subnet Mask to 255.255.255.0

d1 = 255, d2 = 255, d3 = 255, d4 = 0

This command becomes valid only when n=1 (Static) is set by ESC GS ) N (fn=48).

The setting of this command is stored in the nonvolatile memory by ESC GS ) N (fn=112), and will be reflected to the operation after a hardware reset is executed.

### <Function 51> ESC GS ) N pL pH fn m d1 d2 d3 d4 (fn=51)

[Name]	Set Default Gateway												
[Code]	ASCII	ESC	GS	)	N	pL	pH	fn	m	d1	d2	d3	d4
	Hex.	1B	1D	29	4E	pL	pH	fn	m	d1	d2	d3	d4
	Decimal	27	29	41	78	pL	pH	fn	m	d1	d2	d3	d4

[Defined Area] pL = 6, pH = 0  
fn = 51  
m = 1

$0 \leq d1 \leq 255, 0 \leq d2 \leq 255, 0 \leq d3 \leq 255, 0 \leq d4 \leq 255$

[Initial Value] d1 = 0, d2 = 0, d3 = 0, d4 = 0 / Star Configuration setting

[Function] Sets the Default Gateway

d1, d2, d3, and d4 specifies the Default Gateway.

Example: When setting the Default Gateway to 192.168.1.254

d1 = 192, d2 = 168, d3 = 1, d4 = 254

This command becomes valid only when n=1 (Static) is set by ESC GS ) N (fn=48).

The setting of this command is stored in the nonvolatile memory by ESC GS ) N (fn=112), and will be reflected to the operation after a hardware reset is executed.

### <Function 52> ESC GS ) N pL pH fn m n (fn=52)

[Name]	Set DHCP Timeout									
[Code]	ASCII	ESC	GS	)	N	pL	pH	fn	m	n
	Hex.	1B	1D	29	4E	pL	pH	fn	m	n
	Decimal	27	29	41	78	pL	pH	fn	m	n

[Defined Area] pL = 3, pH = 0  
 fn = 52  
 m = 1  
 n = 0,1

[Initial Value] n = 1 / Star Configuration setting

[Function] Set DHCP Timeout  
 n specifies the DHCP Timeout.

n	DHCP Timeout
0	invalid
1	valid

The setting of this command is stored in the nonvolatile memory by ESC GS ) N (fn=112), and will be reflected to the operation after a hardware reset is executed.

### <Function 53> ESC GS ) N pL pH fn m n (fn=53)

[Name]	Set 9100 Multi Session									
[Code]	ASCII	ESC	GS	)	N	pL	pH	fn	m	n
	Hex.	1B	1D	29	4E	pL	pH	fn	m	n
	Decimal	27	29	41	78	pL	pH	fn	m	n

[Defined Area] pL = 3, pH = 0  
 fn = 53  
 m = 1  
 n = 0,1

[Initial Value] n = 0 / Star Configuration setting

[Function] Set 9100 Multi Session  
 n specifies the 9100 Multi Session.

n	9100 Multi Session
0	invalid
1	valid

The setting of this command is stored in the nonvolatile memory by ESC GS ) N (fn=112), and will be reflected to the operation after a hardware reset is executed.

### <Function 54> ESC GS ) N pL pH fn m n (fn=54)

[Name]	Set 9100 Data Timeout										
[Code]	ASCII	ESC	GS	)	N	pL	pH	fn	m	n1	n2
	Hex.	1B	1D	29	4E	pL	pH	fn	m	n1	n2
	Decimal	27	29	41	78	pL	pH	fn	m	n1	n2

[Defined Area] pL = 4, pH = 0  
 fn = 54  
 m = 1  
 n = 0,30,40,60,120,180,300 ( n = n1 + n2x256 )

[Initial Value] n = 0 / Star Configuration setting

[Function] Set 9100 Data Timeout

[Details] n( n = n1 + n2x256 ) specifies the 9100 Data Timeout(Sec.).

The setting of this command is stored in the nonvolatile memory by ESC GS ) N (fn=112), and will be reflected to the operation after a hardware reset is executed.

### <Function 55> ESC GS ) N pL pH fn m n (fn=55)

[Name]	Set Disconnect Message										
[Code]	ASCII	ESC	GS	)	N	pL	pH	fn	m	n	
	Hex.	1B	1D	29	4E	pL	pH	fn	m	n	
	Decimal	27	29	41	78	pL	pH	fn	m	n	

[Defined Area] pL = 3, pH = 0  
 fn = 55  
 m = 1  
 n = 0,1

[Initial Value] n = 0

[Function] Set Disconnect Message

n specifies the Disconnect Message.

n	Disconnect Message
0	invalid
1	valid

The setting of this command is stored in the nonvolatile memory by ESC GS ) N (fn=112), and will be reflected to the operation after a hardware reset is executed.

## <Function 57> ESC GS ) N pL pH fn m n (fn=57)

[Name]	Set SteadyLAN									
[Code]	ASCII	ESC	GS	)	N	pL	pH	fn	m	n
	Hex.	1B	1D	29	4E	pL	pH	fn	m	n
	Decimal	27	29	41	78	pL	pH	fn	m	n

[Defined Area] pL = 3, pH = 0  
 fn = 57  
 m = 1  
 Spec. 1 n = 0,1,2,3  
 Spec. 2 n = 0,1,2,3,128  
 Spec. 3 n = 0,1,2,3,128

[Initial Value] n = 0 / Star Configuration setting

[Function] Sets SteadyLAN.

[Details] n specifies the SteadyLAN setting.

Spec. 1

n	SteadyLAN
0	Invalid
1	Valid (For iOS)
2	Valid (For Android)
3	Valid (For Windows)

Spec. 2

n	SteadyLAN
0	Invalid
1	Valid (For all iOS)
2	Valid (For all iOS)
3	Valid (For all iOS)
128	Valid (For all iOS)

Spec. 3

n	SteadyLAN
0	Invalid
1	Valid (For iOS)
2	Valid (For Android)
3	Valid (For Windows)
128	Valid (For all OS)

Parameter n may or may not be supported depending on the model. The support relationship is as shown in the table below. If not supported, the command is ignored.

n	MCP31L	MCP31C	MCP30	MCP21L	MCP20	MCL32	MCP31CI
0	Supported	Supported	Not supported	Supported	Not supported	Supported	Supported
1	Supported	Not supported	Not supported	Supported	Not supported	Supported	Supported
2	Not supported	Supported	Not supported	Not supported	Not supported	Supported	Supported
3	Not supported	Supported	Not supported	Not supported	Not supported	Supported	Supported
128	Not supported	Not supported	Not supported	Not supported	Not supported	Supported	Supported

The setting of this command is stored in the nonvolatile memory by ESC GS ) N (fn=112), and will be reflected to the operation after a hardware reset is executed.

## <Function 58> ESC GS ) N pL pH fn m d1 d2 d3 d4 (fn=58)

[Name]	Set DNS 1												
[Code]	ASCII	ESC	GS	)	N	pL	pH	fn	m	d1	d2	d3	d4
	Hex.	1B	1D	29	4E	pL	pH	fn	m	d1	d2	d3	d4
	Decimal	27	29	41	78	pL	pH	fn	m	d1	d2	d3	d4

[Defined Area] pL = 6, pH = 0  
 fn = 58  
 m = 1  
 $0 \leq d1 \leq 255, 0 \leq d2 \leq 255, 0 \leq d3 \leq 255, 0 \leq d4 \leq 255$

[Initial Value] d1 = 8, d2 = 8, d3 = 8, d4 = 8 / Star Configuration setting

[Function] Set DNS 1  
 d1, d2, d3, and d4 specifies the DNS 1.  
 Example: When setting the DNS 1 to 1.2.3.4  
 d1 = 1, d2 = 2, d3 = 3, d4 = 4

This command is enabled only when logged in with ESC GS ) N (fn=114) and the login password was changed with ESC GS ) N (fn=128).

The setting of this command is stored in the nonvolatile memory by ESC GS ) N (fn=112), and will be reflected to the operation after a hardware reset is executed.

## <Function 59> ESC GS ) N pL pH fn m d1 d2 d3 d4 (fn=59)

[Name]	Set DNS 2												
[Code]	ASCII	ESC	GS	)	N	pL	pH	fn	m	d1	d2	d3	d4
	Hex.	1B	1D	29	4E	pL	pH	fn	m	d1	d2	d3	d4
	Decimal	27	29	41	78	pL	pH	fn	m	d1	d2	d3	d4

[Defined Area] pL = 6, pH = 0  
 fn = 59  
 m = 1  
 $0 \leq d1 \leq 255, 0 \leq d2 \leq 255, 0 \leq d3 \leq 255, 0 \leq d4 \leq 255$

[Initial Value] d1 = 8, d2 = 8, d3 = 4, d4 = 4 / Star Configuration setting

[Function] Set DNS 2  
 d1, d2, d3, and d4 specifies the DNS 2.  
 Example: When setting the DNS 2 to 1.2.3.4  
 d1 = 1, d2 = 2, d3 = 3, d4 = 4

This command is enabled only when logged in with ESC GS ) N (fn=114) and the login password was changed with ESC GS ) N (fn=128).

The setting of this command is stored in the nonvolatile memory by ESC GS ) N (fn=112), and will be reflected to the operation after a hardware reset is executed.

### <Function 64> ESC GS ) N pL pH fn m (fn=64)

[Name] Transmits the acquisition method for IP address.  
 [Code] ASCII ESC GS ) N pL pH fn m  
 Hex. 1B 1D 29 4E pL pH fn m  
 Decimal 27 29 41 78 pL pH fn m

[Defined Area] pL = 2, pH = 0  
 fn = 64  
 m = 1

[Initial Value] - - -

[Function] Transmits the acquisition method for IP address.  
 The transmission is performed in the format below.  
 ESC GS ) N pL pH fn m n LF NUL

n	IP address acquisition method
0	DHCP
1	Static

### <Function 65> ESC GS ) N pL pH fn m (fn=65)

[Name] Send IP Address  
 [Code] ASCII ESC GS ) N pL pH fn m  
 Hex. 1B 1D 29 4E pL pH fn m  
 Decimal 27 29 41 78 pL pH fn m

[Defined Area] pL = 2, pH = 0  
 fn = 65  
 m = 1

[Initial Value] - - -

[Function] Send IP Address  
 The transmission is performed in the format below.  
 ESC GS ) N pL pH fn m d1 d2 d3 d4 LF NUL

Example 1: When the IP address acquisition method is set to Static, and IP address is set to 192.168.1.10  
 d1 = 192, d2 = 168, d3 = 1, d4 = 10

Example 2: When the IP address acquisition method is set to DHCP, and IP address of 192.168.1.10 is already acquired from the DHCP server  
 d1 = 192, d2 = 168, d3 = 1, d4 = 10

Example 3: When the IP address acquisition method is set to DHCP, and IP address could not be acquired from the DHCP server  
 d1 = 0, d2 = 0, d3 = 0, d4 = 0

### <Function 66> ESC GS ) N pL pH fn m (fn=66)

[Name]	Send subnet mask								
[Code]	ASCII	ESC	GS	)	N	pL	pH	fn	m
	Hex.	1B	1D	29	4E	pL	pH	fn	m
	Decimal	27	29	41	78	pL	pH	fn	m

[Defined Area] pL = 2, pH = 0  
fn = 66  
m = 1

[Initial Value] - - -

[Function] Send Subnet Mask  
The transmission is performed in the format below.  
ESC GS ) N pL pH fn m d1 d2 d3 d4 LF NUL

Example 1: When the IP address acquisition method is set to Static, and Subnet Mask is set to 255.255.255.0  
d1 = 255, d2 = 255, d3 = 255, d4 = 0

Example 2: When the IP address acquisition method is set to DHCP, and Subnet Mask of 255.255.255.0 is already acquired from the DHCP server  
d1 = 255, d2 = 255, d3 = 255, d4 = 0

Example 3: When the IP address acquisition method is set to DHCP, and Subnet Mask could not be acquired from the DHCP server  
d1 = 0, d2 = 0, d3 = 0, d4 = 0

### <Function 67> ESC GS ) N pL pH fn m (fn=67)

[Name]	Send default gateway								
[Code]	ASCII	ESC	GS	)	N	pL	pH	fn	m
	Hex.	1B	1D	29	4E	pL	pH	fn	m
	Decimal	27	29	41	78	pL	pH	fn	m

[Defined Area] pL = 2, pH = 0  
fn = 67  
m = 1

[Initial Value] - - -

[Function] Send Default Gateway  
The transmission is performed in the format below.  
ESC GS ) N pL pH fn m d1 d2 d3 d4 LF NUL

Example 1: When the IP address acquisition method is set to Static, and Default Gateway is set to 255.255.255.0  
d1 = 255, d2 = 255, d3 = 255, d4 = 0

Example 2: When the IP address acquisition method is set to DHCP, and Default Gateway of 255.255.255.0 is already acquired from the DHCP server  
d1 = 255, d2 = 255, d3 = 255, d4 = 0

Example 3: When the IP address acquisition method is set to DHCP, and Default Gateway could not be acquired from the DHCP server  
d1 = 0, d2 = 0, d3 = 0, d4 = 0



### <Function 68> ESC GS ) N pL pH fn m (fn=68)

[Name] Send DHCPTimeout  
 [Code] ASCII ESC GS ) N pL pH fn m  
 Hex. 1B 1D 29 4E pL pH fn m  
 Decimal 27 29 41 78 pL pH fn m

[Defined Area] pL = 2, pH = 0  
 fn = 68  
 m = 1

[Initial Value] - - -

[Function] Send DHCPTimeout  
 The transmission is performed in the format below.  
 ESC GS ) N pL pH fn m n LF NUL

n	DHCP Timeout
0	invalid
1	valid

### <Function 69> ESC GS ) N pL pH fn m (fn=69)

[Name] Send 9100 Multi Session  
 [Code] ASCII ESC GS ) N pL pH fn m  
 Hex. 1B 1D 29 4E pL pH fn m  
 Decimal 27 29 41 78 pL pH fn m

[Defined Area] pL = 2, pH = 0  
 fn = 69  
 m = 1

[Initial Value] - - -

[Function] 9100 Multi Session  
 The transmission is performed in the format below.  
 ESC GS ) N pL pH fn m n LF NUL

n	9100 Multi Session
0	invalid
1	valid

### <Function 70> ESC GS ) N pL pH fn m n (fn=70)

[Name] Send 9100 Data Timeout  
 [Code] ASCII ESC GS ) N pL pH fn m  
 Hex. 1B 1D 29 4E pL pH fn m  
 Decimal 27 29 41 78 pL pH fn m

[Defined Area] pL = 2, pH = 0  
 fn = 70  
 m = 1

[Initial Value] - - -

[Function] Send 9100 Data Timeout  
 The transmission is performed in the format below.  
 ESC GS ) N pL pH fn m n1 n2 LF NUL

n1 + ( n = n1 + n2x256 ) specifies the 9100 Data Timeout (Sec.).

Example 1: When the 9100 data timeout method is set 300 Sec.  
 n1 = 44, n2 = 1

### <Function 71> ESC GS ) N pL pH fn m n (fn=71)

[Name] Send Disconnect Message  
 [Code] ASCII ESC GS ) N pL pH fn m  
 Hex. 1B 1D 29 4E pL pH fn m  
 Decimal 27 29 41 78 pL pH fn m

[Defined Area] pL = 2, pH = 0  
 fn = 71  
 m = 1

[Initial Value] - - -

[Function] Send Disconnect Message  
 The transmission is performed in the format below.  
 ESC GS ) N pL pH fn m n LF NUL

n	Disconnect Message
0	invalid
1	valid

## <Function 73> ESC GS ) N pL pH fn m (fn=73)

[Name]	Send SteadyLAN									
[Code]	ASCII	ESC	GS	)	N	pL	pH	fn	m	n
	Hex.	1B	1D	29	4E	pL	pH	fn	m	n
	Decimal	27	29	41	78	pL	pH	fn	m	n

[Defined Area] pL = 2, pH = 0  
fn = 73  
m = 1

[Initial Value] ---

[Function] Send SteadyLAN setting.  
The transmission is performed in the format below.  
ESC GS ) N pL pH fn m n LF NUL

### Spec. 1

n	SteadyLAN
0	Invalid
1	Valid (For iOS)
2	Valid (For Android)
3	Valid (For Windows)

### Spec. 2

n	SteadyLAN
0	Invalid
1	Valid (For all iOS)
2	Valid (For all iOS)
3	Valid (For all iOS)
128	Valid (For all iOS)

### Spec.3

n	SteadyLAN
0	Invalid
1	Valid (For iOS)
2	Valid (For Android)
3	Valid (For Windows)
128	Valid (For all OS)

## <Function 74> ESC GS ) N pL pH fn m (fn=74)

[Name] Send DNS 1

[Code]	ASCII	ESC	GS	)	N	pL	pH	fn	m
	Hex.	1B	1D	29	4E	pL	pH	fn	m
	Decimal	27	29	41	78	pL	pH	fn	m

[Defined Area] pL = 2, pH = 0  
fn = 74  
m = 1

[Initial Value] ---

[Function] Send DNS 1

The transmission is performed in the format below.

ESC GS ) N pL pH fn m d1 d2 d3 d4 LF NUL

Example: When setting the DNS 1 to 1.2.3.4

d1 = 1, d2 = 2, d3 = 3, d4 = 4

This command is enabled only when logged in with ESC GS ) N (fn=114) and the login password was changed with ESC GS ) N (fn=128).

At other times, transmission is performed in the format below.

ESC GS ) N pL pH fn m LF NUL

## <Function 75> ESC GS ) N pL pH fn m (fn=75)

[Name] Send DNS 2

[Code]	ASCII	ESC	GS	)	N	pL	pH	fn	m
	Hex.	1B	1D	29	4E	pL	pH	fn	m
	Decimal	27	29	41	78	pL	pH	fn	m

[Defined Area] pL = 2, pH = 0  
fn = 75  
m = 1

[Initial Value] ---

[Function] Send DNS 2

The transmission is performed in the format below.

ESC GS ) N pL pH fn m d1 d2 d3 d4 LF NUL

Example: When setting the DNS 2 to 1.2.3.4

d1 = 1, d2 = 2, d3 = 3, d4 = 4

This command is enabled only when logged in with ESC GS ) N (fn=114) and the login password was changed with ESC GS ) N (fn=128).

At other times, transmission is performed in the format below.

ESC GS ) N pL pH fn m LF NUL

### <Function 80> ESC GS ) N pL pH fn m n (fn=80)

[Name] Set TCP#9100  
 [Code] ASCII ESC GS ) N pL pH fn m n  
 Hex. 1B 1D 29 4E pL pH fn m n  
 Decimal 27 29 41 78 pL pH fn m n

[Defined Area] pL = 3, pH = 0  
 fn = 80  
 m = 1  
 n = 0,1

[Initial Value] n = 1 / Star Configuration setting

[Function] Set the TCP#9100

[Details] n specifies TCP#9100 setting.

n	TCP#9100
0	Invalid
1	Valid

The setting of this command is stored in the nonvolatile memory by ESC GS ) N (fn=112), and will be reflected to the operation after a hardware reset is executed.

### <Function 81> ESC GS ) N pL pH fn m (fn=81)

[Name] Send TCP#9100  
 [Code] ASCII ESC GS ) N pL pH fn m  
 Hex. 1B 1D 29 4E pL pH fn m  
 Decimal 27 29 41 78 pL pH fn m

[Defined Area] pL = 2, pH = 0  
 fn = 81  
 m = 1

[Initial Value] ---

[Function] Send TCP#9100 setting.

The transmission is performed in the format below.

ESC GS ) N pL pH fn m n LF NUL

N	TCP#9100
0	Invalid
1	Valid

### <Function 82> ESC GS ) N pL pH fn m n (fn=82)

[Name] Set TCP#9101  
 [Code] ASCII ESC GS ) N pL pH fn m n  
 Hex. 1B 1D 29 4E pL pH fn m n  
 Decimal 27 29 41 78 pL pH fn m n

[Defined Area] pL = 3, pH = 0  
 fn = 82  
 m = 1  
 n = 0,1

[Initial Value] n = 1 / Star Configuration setting

[Function] Set the TCP#9101

[Details] n specifies TCP#9101 setting.

n	TCP#9101
0	Invalid
1	Valid

The setting of this command is stored in the nonvolatile memory by ESC GS ) N (fn=112), and will be reflected to the operation after a hardware reset is executed.

### <Function 83> ESC GS ) N pL pH fn m (fn=83)

[Name] Send TCP#9101  
 [Code] ASCII ESC GS ) N pL pH fn m  
 Hex. 1B 1D 29 4E pL pH fn m  
 Decimal 27 29 41 78 pL pH fn m

[Defined Area] pL = 2, pH = 0  
 fn = 83  
 m = 1

[Initial Value] ---

[Function] Send TCP#9101.

The transmission is performed in the format below.

ESC GS ) N pL pH fn m n LF NUL

N	TCP#9101
0	Invalid
1	Valid

### <Function 84> ESC GS ) N pL pH fn m n (fn=84)

[Name]	Set LPR									
[Code]	ASCII	ESC	GS	)	N	pL	pH	fn	m	n
	Hex.	1B	1D	29	4E	pL	pH	fn	m	n
	Decimal	27	29	41	78	pL	pH	fn	m	n

[Defined Area] pL = 3, pH = 0  
 fn = 84  
 m = 1  
 n = 0,1

[Initial Value] n = 1

[Function] Set the LPR.

[Details] n specifies LPR setting.

n	LPR
0	Invalid
1	Valid

The setting of this command is stored in the nonvolatile memory by ESC GS ) N (fn=112), and will be reflected to the operation after a hardware reset is executed.

### <Function 85> ESC GS ) N pL pH fn m (fn=85)

[Name]	Send LPR									
[Code]	ASCII	ESC	GS	)	N	pL	pH	fn	m	
	Hex.	1B	1D	29	4E	pL	pH	fn	m	
	Decimal	27	29	41	78	pL	pH	fn	m	

[Defined Area] pL = 2, pH = 0  
 fn = 85  
 m = 1

[Initial Value] ---

[Function] Send LPR setting.

The transmission is performed in the format below.

ESC GS ) N pL pH fn m n LF NUL

N	LPR
0	Invalid
1	Valid



### <Function 86> ESC GS ) N pL pH fn m n (fn=86)

[Name] Set UDP#22222  
 [Code] ASCII ESC GS ) N pL pH fn m n  
 Hex. 1B 1D 29 4E pL pH fn m n  
 Decimal 27 29 41 78 pL pH fn m n

[Defined Area] pL = 3, pH = 0  
 fn = 86  
 m = 1  
 n = 0,1

[Initial Value] n = 1 / Star Configuration setting

[Function] Set the UDP#22222.

[Details] n specifies UDP#22222 setting.

n	UDP#22222
0	Invalid
1	Valid

The setting of this command is stored in the nonvolatile memory by ESC GS ) N (fn=112), and will be reflected to the operation after a hardware reset is executed.

### <Function 87> ESC GS ) N pL pH fn m (fn=87)

[Name] Send UDP#22222  
 [Code] ASCII ESC GS ) N pL pH fn m  
 Hex. 1B 1D 29 4E pL pH fn m  
 Decimal 27 29 41 78 pL pH fn m

[Defined Area] pL = 2, pH = 0  
 fn = 87  
 m = 1

[Initial Value] ---

[Function] Send UDP#22222 setting.

The transmission is performed in the format below.

ESC GS ) N pL pH fn m n LF NUL

N	UDP#22222
0	Invalid
1	Valid

### <Function 88> ESC GS ) N pL pH fn m n (fn=88)

[Name]	Set Telnet									
[Code]	ASCII	ESC	GS	)	N	pL	pH	fn	m	n
	Hex.	1B	1D	29	4E	pL	pH	fn	m	n
	Decimal	27	29	41	78	pL	pH	fn	m	n

[Defined Area] pL = 3, pH = 0  
 fn = 88  
 m = 1  
 n = 0,1

[Initial Value] n = 1

[Function] Set the Telnet.

[Details] n specifies Telnet setting.

n	Telnet
0	Invalid
1	Valid

The setting of this command is stored in the nonvolatile memory by ESC GS ) N (fn=112), and will be reflected to the operation after a hardware reset is executed.

### <Function 89> ESC GS ) N pL pH fn m (fn=89)

[Name]	Send Telnet									
[Code]	ASCII	ESC	GS	)	N	pL	pH	fn	m	
	Hex.	1B	1D	29	4E	pL	pH	fn	m	
	Decimal	27	29	41	78	pL	pH	fn	m	

[Defined Area] pL = 2, pH = 0  
 fn = 89  
 m = 1

[Initial Value] ---

[Function] Send Telnet setting.

The transmission is performed in the format below.

ESC GS ) N pL pH fn m n LF NUL

N	Telnet
0	Invalid
1	Valid

### <Function 90> ESC GS ) N pL pH fn m n (fn=90)

[Name] Set TCP#80  
 [Code] ASCII ESC GS ) N pL pH fn m n  
 Hex. 1B 1D 29 4E pL pH fn m n  
 Decimal 27 29 41 78 pL pH fn m n

[Defined Area] pL = 3, pH = 0  
 fn = 90  
 m = 1  
 n = 0,1

[Initial Value] n = 1

[Function] Set the TCP#80.

[Details] n specifies TCP#80 setting.

n	TCP#80
0	Invalid
1	Valid

The setting of this command is stored in the nonvolatile memory by ESC GS ) N (fn=112), and will be reflected to the operation after a hardware reset is executed.

### <Function 91> ESC GS ) N pL pH fn m (fn=91)

[Name] Send TCP#80  
 [Code] ASCII ESC GS ) N pL pH fn m  
 Hex. 1B 1D 29 4E pL pH fn m  
 Decimal 27 29 41 78 pL pH fn m

[Defined Area] pL = 2, pH = 0  
 fn = 91  
 m = 1

[Initial Value] ---

[Function] Send TCP#80 setting.

The transmission is performed in the format below.

ESC GS ) N pL pH fn m n LF NUL

N	TCP#80
0	Invalid
1	Valid

### <Function 92> ESC GS ) N pL pH fn m n (fn=92)

[Name] Set TCP#443

[Code] ASCII ESC GS ) N pL pH fn m n  
 Hex. 1B 1D 29 4E pL pH fn m n  
 Decimal 27 29 41 78 pL pH fn m n

[Defined Area] pL = 3, pH = 0  
 fn = 92  
 m = 1  
 n = 0,1

[Initial Value] n = 1

[Function] Set the TCP#443.

[Details] n specifies TCP#443 setting.

n	TCP#443
0	Invalid
1	Valid

The setting of this command is stored in the nonvolatile memory by ESC GS ) N (fn=112), and will be reflected to the operation after a hardware reset is executed.

### <Function 93> ESC GS ) N pL pH fn m (fn=93)

[Name] Send TCP#443

[Code] ASCII ESC GS ) N pL pH fn m  
 Hex. 1B 1D 29 4E pL pH fn m  
 Decimal 27 29 41 78 pL pH fn m

[Defined Area] pL = 2, pH = 0  
 fn = 93  
 m = 1

[Initial Value] ---

[Function] Send TCP#443 setting.

The transmission is performed in the format below.

ESC GS ) N pL pH fn m n LF NUL

N	TCP#443
0	Invalid
1	Valid

### <Function 94> ESC GS ) N pL pH fn m n (fn=94)

[Name] Set TCP#22222  
 [Code] ASCII ESC GS ) N pL pH fn m n  
 Hex. 1B 1D 29 4E pL pH fn m n  
 Decimal 27 29 41 78 pL pH fn m n

[Defined Area] pL = 3, pH = 0  
 fn = 94  
 m = 1  
 n = 0,1

[Initial Value] n = 1

[Function] Set the TCP#22222.

[Details] n specifies TCP#22222 setting.

n	TCP#22222
0	Invalid
1	Valid

The setting of this command is stored in the nonvolatile memory by ESC GS ) N (fn=112), and will be reflected to the operation after a hardware reset is executed.

### <Function 95> ESC GS ) N pL pH fn m (fn=95)

[Name] Send TCP#22222  
 [Code] ASCII ESC GS ) N pL pH fn m  
 Hex. 1B 1D 29 4E pL pH fn m  
 Decimal 27 29 41 78 pL pH fn m

[Defined Area] pL = 2, pH = 0  
 fn = 95  
 m = 1

[Initial Value] ---

[Function] Send TCP#22222 setting.

The transmission is performed in the format below.

ESC GS ) N pL pH fn m n LF NUL

N	TCP#22222
0	Invalid
1	Valid

## <Function 112> ESC GS ) N pL pH fn m n (fn=112)

[Name] Save network parameter

[Code]	ASCII	ESC	GS	)	N	pL	pH	fn	m	n
	Hex.	1B	1D	29	4E	pL	pH	fn	m	n
	Decimal	27	29	41	78	pL	pH	fn	m	n

[Defined Area] pL = 3, pH = 0  
 fn = 112  
 m = 1  
 n = 0, 1

[Initial Value] ---

[Function] In the cases above, the network parameter set by the command below is stored in the nonvolatile memory, and a hardware reset is executed.

ESC GS ) N (fn=48)	Set network parameters
ESC GS ) N (fn=49)	Set IP Address
ESC GS ) N (fn=50)	Set subnet mask
ESC GS ) N (fn=51)	Set default gateway
ESC GS ) N (fn=52)	Set DHCP Timeout
ESC GS ) N (fn=53)	Set 9100 Multi Session
ESC GS ) N (fn=54)	Set 9100 Data Timeout
ESC GS ) N (fn=55)	Set Disconnect Message
ESC GS ) N (fn=57)	Set SteadyLAN
ESC GS ) N (fn=58)	Set DNS 1 *1
ESC GS ) N (fn=59)	Set DNS 2 *1
ESC GS ) N (fn=80)	Set TCP#9100
ESC GS ) N (fn=82)	Set TCP#9101
ESC GS ) N (fn=84)	Set LPR
ESC GS ) N (fn=86)	Set UDP#22222
ESC GS ) N (fn=88)	Set Telnet
ESC GS ) N (fn=90)	Set TCP#80
ESC GS ) N (fn=92)	Set TCP#433
ESC GS ) N (fn=94)	Set TCP#22222
ESC GS ) N (fn=128)	Set log in password *1
ESC GS ) N (fn=130)	Set Star CloudPRNT Cloud Service *1
ESC GS ) N (fn=132)	Set Star CloudPRNT Service URL *1
ESC GS ) N (fn=134)	Set Star CloudPRNT Polling time *1
ESC GS ) N (fn=136)	Set Star CloudPRNT User Name *1
ESC GS ) N (fn=138)	Set Star CloudPRNT Password *1
ESC GS ) N (fn=140)	Set Star CloudPRNT TLS trust level *1
ESC GS ) N (fn=142)	Set Star CloudPRNT NTP Server *1
ESC GS ) N (fn=144)	Set Star CloudPRNT TLS1.2 Cipher Suite Encryption Level *1
ESC GS ) N (fn=146)	Set Star CloudPRNT TLS1.3 *1
ESC GS ) N (fn=152)	Set Star CloudPRNT HTTP Response Timeout *1

\*1 : Saved only when logged in with ESC GS ) N (fn=114) and the login password was changed with ESC GS ) N (fn=128).

After this command was sent, the next data must not be sent until the printer becomes online (becomes able to receive data).

"n" specifies whether or not the self print is performed after the hardware reset.

n	Self print after hardware reset
0	Without self print
1	With self print

## <Function 113> ESC GS ) N pL pH fn m n (fn=113)

[Name] Initialize network parameter

[Code]	ASCII	ESC	GS	)	N	pL	pH	fn	m	n
	Hex.	1B	1D	29	4E	pL	pH	fn	m	n
	Decimal	27	29	41	78	pL	pH	fn	m	n

[Defined Area] pL = 3, pH = 0  
fn = 113  
m = 1  
n = 0, 1

[Initial Value] ---

[Function] Initializes the network parameter stored in the nonvolatile memory, and executes a hardware reset.

ESC GS ) N (fn=48)	Set network parameters
ESC GS ) N (fn=49)	Set IP Address
ESC GS ) N (fn=50)	Set subnet mask
ESC GS ) N (fn=51)	Set default gateway
ESC GS ) N (fn=52)	Set DHCPTimeout
ESC GS ) N (fn=53)	Set 9100 Multi Session
ESC GS ) N (fn=54)	Set 9100 Data Timeout
ESC GS ) N (fn=55)	Set Disconnect Message
ESC GS ) N (fn=57)	Set SteadyLAN
ESC GS ) N (fn=58)	Set DNS 1 *1
ESC GS ) N (fn=59)	Set DNS 2 *1
ESC GS ) N (fn=80)	Set TCP#9100
ESC GS ) N (fn=82)	Set TCP#9101
ESC GS ) N (fn=84)	Set LPR
ESC GS ) N (fn=86)	Set UDP#22222
ESC GS ) N (fn=88)	Set Telnet
ESC GS ) N (fn=90)	Set TCP#80
ESC GS ) N (fn=92)	Set TCP#433
ESC GS ) N (fn=94)	Set TCP#22222
ESC GS ) N (fn=128)	Set log in password *1
ESC GS ) N (fn=130)	Set Star CloudPRNT Cloud Service *1
ESC GS ) N (fn=132)	Set Star CloudPRNT Service URL *1
ESC GS ) N (fn=134)	Set Star CloudPRNT Polling time *1
ESC GS ) N (fn=136)	Set Star CloudPRNT User Name *1
ESC GS ) N (fn=138)	Set Star CloudPRNT Password *1
ESC GS ) N (fn=140)	Set Star CloudPRNT TLS trust level *1
ESC GS ) N (fn=142)	Set Star CloudPRNT NTP Server *1
ESC GS ) N (fn=144)	Set Star CloudPRNT TLS1.2 Cipher Suite Encryption Level *1
ESC GS ) N (fn=146)	Set Star CloudPRNT TLS1.3 *1
ESC GS ) N (fn=152)	Set Star CloudPRNT HTTP Response Timeout *1

\*1 : Initialized only when logged in with ESC GS ) N (fn=114) and the login password was changed with ESC GS ) N (fn=128).

"n" specifies whether or not the self print is performed after the hardware reset.

n	Self print after hardware reset
0	Without self print
1	With self print

### <Function 114> ESC GS ) N pL pH fn m d1 ... dk (fn=114)

[Name]	Execute Login											
[Code]	ASCII	ESC	GS	)	N	pL	pH	fn	m	d1	...	dk
	Hex.	1B	1D	29	4E	pL	pH	fn	m	d1	...	dk
	Decimal	27	29	41	78	pL	pH	fn	m	d1	...	dk

[Defined Area]  $3 \leq pL+pH \times 256 = k+2 \leq 33$   
 $fn = 114$   
 $m = 1$   
 $k = (pL+pH \times 256)$   
 $32 \leq d \leq 126$

[Initial Value] ---

[Function] Execute login.  
 d1 ... dk specifies the login password.  
 Example: When specifying password "abcd1234"  
 $d1 = 97(0x61)$ ,  $d2 = 98(0x62)$ ,  $d3 = 99(0x63)$ ,  $d4 = 100(0x64)$ ,  $d5 = 49(0x31)$ ,  $d6 = 50(0x32)$ ,  
 $d7 = 51(0x33)$ ,  $d8 = 52(0x34)$

Depending on the function, the network parameter setting command may be enabled only when logged in.

For details, refer to the network parameter setting command.

### <Function 115> ESC GS ) N pL pH fn m (fn=115)

[Name]	Send Login Status									
[Code]	ASCII	ESC	GS	)	N	pL	pH	fn	m	
	Hex.	1B	1D	29	4E	pL	pH	fn	m	
	Decimal	27	29	41	78	pL	pH	fn	m	

[Defined Area]  $pL = 2$ ,  $pH = 0$   
 $fn = 115$   
 $m = 1$

[Initial Value] ---

[Function] Send Lgin status.  
 The transmission is performed in the format below.  
 ESC GS ) N pL pH fn m n LF NUL

n	Login status
0	Not logged in
1	Logged in



### <Function 116> ESC GS ) N pL pH fn m n (fn=116)

[Name]	Execute Logout									
[Code]	ASCII	ESC	GS	)	N	pL	pH	fn	m	n
	Hex.	1B	1D	29	4E	pL	pH	fn	m	n
	Decimal	27	29	41	78	pL	pH	fn	m	n

[Defined Area]     pL = 3, pH = 0  
                       fn = 116  
                       m = 1  
                       n = 0

[Initial Value]     ---

[Function]          Execute Logout.

This command is enabled only when logged in with ESC GS ) N (fn=114).

Depending on the function, the network parameter setting command may be enabled only when logged in.

For details, refer to the network parameter setting command.

### <Function 128> ESC GS ) N pL pH fn m d1 ... dk (fn=128)

[Name]	Set Login Password											
[Code]	ASCII	ESC	GS	)	N	pL	pH	fn	m	d1	...	dk
	Hex.	1B	1D	29	4E	pL	pH	fn	m	d1	...	dk
	Decimal	27	29	41	78	pL	pH	fn	m	d1	...	dk

[Defined Area]  $3 \leq pL + pH \times 256 = k + 2 \leq 33$   
 $fn = 128$   
 $m = 1$

$pL + pH \times 256 = k + 2$   
 $32 \leq d \leq 126$

[Initial Value] "public"  
 $k = 6$ ,  $d1 = 112(0x70)$ ,  $d2 = 117(0x75)$ ,  $d3 = 98(0x62)$ ,  $d4 = 108(0x6C)$ ,  $d5 = 105(0x69)$ ,  $d6 = 99(0x63)$

[Function] Set Login Password.  
 d1 ... dk specifies the login password.  
 Example: When setting password to "abcd1234"  
 $d1 = 97(0x61)$ ,  $d2 = 98(0x62)$ ,  $d3 = 99(0x63)$ ,  $d4 = 100(0x64)$ ,  $d5 = 49(0x31)$ ,  $d6 = 50(0x32)$ ,  $d7 = 51(0x33)$ ,  $d8 = 52(0x34)$

This command is enabled only when logged in with ESC GS ) N (fn=114).

The setting of this command is applied to operation when this command is processed, and is saved in nonvolatile memory by ESC GS ) N (fn=112).

Depending on the function, the network parameter setting command may be enabled only when the login password was changed.

For details, refer to the network parameter setting command.

### <Function 129> ESC GS ) N pL pH fn m (fn=129)

[Name]	Send Login Password Change Status								
[Code]	ASCII	ESC	GS	)	N	pL	pH	fn	m
	Hex.	1B	1D	29	4E	pL	pH	fn	m
	Decimal	27	29	41	78	pL	pH	fn	m

[Defined Area]  $pL = 2$ ,  $pH = 0$   
 $fn = 129$   
 $m = 1$

[Initial Value] ---

[Function] Send Login Password Change Status.  
 The transmission is performed in the format below.  
 ESC GS ) N pL pH fn m n LF NUL

n	Login password change status
0	Login password not changed
1	Login password changed

This command is enabled only when logged in with ESC GS ) N (fn=114).

At other times, transmission is performed in the format below.

ESC GS ) N pL pH fn m LF NUL

### <Function 130> ESC GS ) N pL pH fn m n (fn=130)

[Name]	Set Star CloudPRNT Cloud Service									
[Code]	ASCII	ESC	GS	)	N	pL	pH	fn	m	n
	Hex.	1B	1D	29	4E	pL	pH	fn	m	n
	Decimal	27	29	41	78	pL	pH	fn	m	n

[Defined Area] pL = 3, pH = 0  
 fn = 130  
 m = 1  
 n = 0,1

[Initial Value] n = 0 / Star Configuration setting

[Function] Set Star CloudPRNT Cloud Service.

[Details] n specifies the Star CloudPRNT Cloud Service setting.

n	Star CloudPRNT Cloud Service
0	Invalid
1	Valid

This command is enabled only when logged in with ESC GS ) N (fn=114) and the login password was changed with ESC GS ) N (fn=128).

The setting of this command is saved in nonvolatile memory by ESC GS ) N (fn=112), and will be applied to operation after a hardware reset is executed.

### <Function 131> ESC GS ) N pL pH fn m (fn=131)

[Name]	Send Star CloudPRNT Cloud Service								
[Code]	ASCII	ESC	GS	)	N	pL	pH	fn	m
	Hex.	1B	1D	29	4E	pL	pH	fn	m
	Decimal	27	29	41	78	pL	pH	fn	m

[Defined Area] pL = 2, pH = 0  
 fn = 131  
 m = 1

[Initial Value] ---

[Function] Send Star CloudPRNT Cloud Service setting.  
 The transmission is performed in the format below.

ESC GS ) N pL pH fn m n LF NUL

n	Star CloudPRNT Cloud Service
0	Invalid
1	Valid

This command is enabled only when logged in with ESC GS ) N (fn=114) and the login password was changed with ESC GS ) N (fn=128).

At other times, transmission is performed in the format below.

ESC GS ) N pL pH fn m LF NUL

### **<Function 132> ESC GS ) N pL pH fn m d1 ... dk (fn=132)**

[Name]	Set Star CloudPRNT Service URL											
[Code]	ASCII	ESC	GS	)	N	pL	pH	fn	m	d1	...	dk
	Hex.	1B	1D	29	4E	pL	pH	fn	m	d1	...	dk
	Decimal	27	29	41	78	pL	pH	fn	m	d1	...	dk

[Defined Area]  $3 \leq pL + pH \times 256 = k + 2 \leq 513$   
 $fn = 132$   
 $m = 1$   
 $32 \leq d \leq 126$

[Initial Value] --- / Star Configuration setting

[Function] Set Star CloudPRNT Service URL.

[Details] d1 ... dk specifies the Star CloudPRNT Service URL.

This command is enabled only when logged in with ESC GS ) N (fn=114) and the login password was changed with ESC GS ) N (fn=128).

This command is enabled only when n=1 (Enabled) is set by ESC GS ) N (fn=130).

The setting of this command is saved in the nonvolatile memory by ESC GS ) N (fn=112), and will be applied to operation after a hardware reset is executed.

### **<Function 133> ESC GS ) N pL pH fn m (fn=133)**

[Name]	Send Star CloudPRNT Service URL								
[Code]	ASCII	ESC	GS	)	N	pL	pH	fn	m
	Hex.	1B	1D	29	4E	pL	pH	fn	m
	Decimal	27	29	41	78	pL	pH	fn	m

[Defined Area] pL = 2, pH = 0  
 $fn = 133$   
 $m = 1$

[Initial Value] ---

[Function] Send Star CloudPRNT Service URL.

The transmission is performed in the format below.

ESC GS ) N pL pH fn m d1 ... dk LF NUL

d1 ... dk indicates the Star CloudPRNT Service URL.

This command is enabled only when logged in with ESC GS ) N (fn=114) and the log in password was changed with ESC GS ) N (fn=128).

At other times, transmission is performed in the format below.

ESC GS ) N pL pH fn m LF NUL

### **<Function 134> ESC GS ) N pL pH fn m n1 n2 (fn=134)**

[Name]	Set Star CloudPRNT Polling time										
[Code]	ASCII	ESC	GS	)	N	pL	pH	fn	m	n1	n2
	Hex.	1B	1D	29	4E	pL	pH	fn	m	n1	n2
	Decimal	27	29	41	78	pL	pH	fn	m	n1	n2

[Defined Area] pL = 4, pH = 0  
fn = 134  
m = 1

$$1 \leq n1 + n2 \times 256 \leq 7200$$

[Initial Value] n1 = 5, n2 = 0 / Star Configuration setting

[Function] Set Star CloudPRNT Polling time.

[Details] (n1+n2×256) specifies the Star CloudPRNT Polling time (sec.).

This command is enabled only when logged in with ESC GS ) N (fn=114) and the login password was changed with ESC GS ) N (fn=128).

This command is enabled only when n=1 (Enabled) is set by ESC GS ) N (fn=130).

The setting of this command is saved in the nonvolatile memory by ESC GS ) N (fn=112), and will be applied to operation after a hardware reset is executed.

### **<Function 135> ESC GS ) N pL pH fn m (fn=135)**

[Name]	Send Star CloudPRNT Polling time									
[Code]	ASCII	ESC	GS	)	N	pL	pH	fn	m	
	Hex.	1B	1D	29	4E	pL	pH	fn	m	
	Decimal	27	29	41	78	pL	pH	fn	m	

[Defined Area] pL = 2, pH = 0  
fn = 135  
m = 1

[Initial Value] ---

[Function] Send Star CloudPRNT Polling time.

The transmission is performed in the format below.

ESC GS ) N pL pH fn m n1 n2 LF NUL

(n1+n2×256) indicates the Star CloudPRNT Polling time.

This command is enabled only when logged in with ESC GS ) N (fn=114) and the login password was changed with ESC GS ) N (fn=128).

At other times, transmission is performed in the format below.

ESC GS ) N pL pH fn m LF NUL

### <Function 136> ESC GS ) N pL pH fn m d1 ... dk (fn=136)

[Name]	Set Star CloudPRNT User Name											
[Code]	ASCII	ESC	GS	)	N	pL	pH	fn	m	d1	...	dk
	Hex.	1B	1D	29	4E	pL	pH	fn	m	d1	...	dk
	Decimal	27	29	41	78	pL	pH	fn	m	d1	...	dk

[Defined Area]  $2 \leq pL + pH \times 256 = k + 2 \leq 65$   
 $fn = 136$   
 $m = 1$   
 $32 \leq d \leq 126$

[Initial Value] --- / Star Configuration setting

[Function] Set Star CloudPRNT User Name.

[Details] d1 ... dk specifies the Star CloudPRNT User Name.

When d is not entered, the value is not specified (default value).

This command is enabled only when logged in with ESC GS ) N (fn=114) and the login password was changed with ESC GS ) N (fn=128).

This command is enabled only when n=1 (Enabled) is set by ESC GS ) N (fn=130).

The setting of this command is saved in the nonvolatile memory by ESC GS ) N (fn=112), and will be applied to operation after a hardware reset is executed.

### <Function 137> ESC GS ) N pL pH fn m (fn=137)

[Name]	Send Star CloudPRNT User Name								
[Code]	ASCII	ESC	GS	)	N	pL	pH	fn	m
	Hex.	1B	1D	29	4E	pL	pH	fn	m
	Decimal	27	29	41	78	pL	pH	fn	m

[Defined Area] pL = 2, pH = 0  
 $fn = 137$   
 $m = 1$

[Initial Value] ---

[Function] Send Star CloudPRNT User Name.

The transmission is performed in the format below.

ESC GS ) N pL pH fn m d1 ... dk LF NUL

d1 ... dk indicate the Star CloudPRNT User Name.

This command is enabled only when logged in with ESC GS ) N (fn=114) and the login password was changed with ESC GS ) N (fn=128).

At other times, transmission is performed in the format below.

ESC GS ) N pL pH fn m LF NUL

### <Function 138> ESC GS ) N pL pH fn m d1 ... dk (fn=138)

[Name]	Set Star CloudPRNT Password											
[Code]	ASCII	ESC	GS	)	N	pL	pH	fn	m	d1	...	dk
	Hex.	1B	1D	29	4E	pL	pH	fn	m	d1	...	dk
	Decimal	27	29	41	78	pL	pH	fn	m	d1	...	dk

[Defined Area]  $2 \leq pL + pH \times 256 = k + 2 \leq 65$   
 $fn = 138$   
 $m = 1$   
 $32 \leq d \leq 126$

[Initial Value] --- / Star Configuration setting

[Function] Set Star CloudPRNT Password.

[Details] d1 ... dk specifies the Star CloudPRNT Password.

When d is not entered, the value is not specified (default value).

This command is enabled only when logged in with ESC GS ) N (fn=114) and the login password was changed with ESC GS ) N (fn=128).

This command is enabled only when n=1 (Enabled) is set by ESC GS ) N (fn=130).

The setting of this command is saved in the nonvolatile memory by ESC GS ) N (fn=112), and will be applied to operation after a hardware reset is executed.

### <Function 139> ESC GS ) N pL pH fn m (fn=139)

[Name]	Send Star CloudPRNT Password								
[Code]	ASCII	ESC	GS	)	N	pL	pH	fn	m
	Hex.	1B	1D	29	4E	pL	pH	fn	m
	Decimal	27	29	41	78	pL	pH	fn	m

[Defined Area]  $pL = 2, pH = 0$   
 $fn = 139$   
 $m = 1$

[Initial Value] ---

[Function] Send Star CloudPRNT Password.

The transmission is performed in the format below.

ESC GS ) N pL pH fn m d1 ... dk LF NUL

d1 ... dk indicates the Star CloudPRNT Password.

This command is enabled only when logged in with ESC GS ) N (fn=114) and the login password was changed with ESC GS ) N (fn=128).

At other times, transmission is performed in the format below.

ESC GS ) N pL pH fn m LF NUL

## <Function 140> ESC GS ) N pL pH fn m n d1 ... dk (fn=140)

[Name]	Set Star CloudPRNT TLS trust level												
[Code]	ASCII	ESC	GS	)	N	pL	pH	fn	m	n	d1	...	dk
	Hex.	1B	1D	29	4E	pL	pH	fn	m	n	d1	...	dk
	Decimal	27	29	41	78	pL	pH	fn	m	n	d1	...	dk

[Defined Area] Spec. 1  
 $3 \leq pL + pH \times 256 = k + 3 \leq 4097$   
 Spec. 2  
 $3 \leq pL + pH \times 256 = k + 3 \leq 61413$

fn = 140  
 m = 1  
 n = 0, 1, 2  
 $pL + pH \times 256 = k + 3$   
 $0 \leq d \leq 255$

[Initial Value] n = 0 / Star Configuration setting  
 [Function] Set Send Star CloudPRNT TLS trust level.  
 [Details] n specifies the Star CloudPRNT TLS trust level.

n	Star CloudPRNT TLS trust level
0	Use trusted CA-Certificate list
1	Use custom CA-Certificate
2	Accept all

When n=1, d1 ... dk specifies the CA certificate (PEM format).

Spec. 1

Only one CA certificate can be set as a d1...dk. No more certificates will be set.

Spec. 2

The number of CA certificates that can be set is max. 15, as a d1...dk. No more certificates will be set.

This command is enabled only when logged in with ESC GS ) N (fn=114) and the login password was changed with ESC GS ) N (fn=128).

The setting of this command is saved in nonvolatile memory by ESC GS ) N (fn=112), and will be applied to operation after a hardware reset is executed.



## <Function 141> ESC GS ) N pL pH fn m (fn=141)

[Name] Send Star CloudPRNT TLS trust level  
 [Code] ASCII ESC GS ) N pL pH fn m  
 Hex. 1B 1D 29 4E pL pH fn m  
 Decimal 27 29 41 78 pL pH fn m

[Defined Area] pL = 2, pH = 0  
 fn = 141  
 m = 1

[Initial Value] --- / Star Configuration setting

[Function] Send Send Star CloudPRNT TLS trust level.  
 The transmission is performed in the format below.  
 ESC GS ) N pL pH fn m n LF NUL

n	Star CloudPRNT TLS trust level
0	Use trusted CA-Certificate list
1	Use custom CA-Certificate
2	Accept all

This command is enabled only when logged in with ESC GS ) N (fn=114) and the login password was changed with ESC GS ) N (fn=128).

At other times, transmission is performed in the format below.

ESC GS ) N pL pH fn m LF NUL

### <Function 142> ESC GS ) N pL pH fn m n d1 ... dk (fn=142)

[Name]	Set Star CloudPRNT NTP Server												
[Code]	ASCII	ESC	GS	)	N	pL	pH	fn	m	n	d1	...	dk
	Hex.	1B	1D	29	4E	pL	pH	fn	m	n	d1	...	dk
	Decimal	27	29	41	78	pL	pH	fn	m	n	d1	...	dk

[Defined Area]  $3 \leq pL + pH \times 256 = k + 3 \leq 256$   
 $fn = 142$   
 $m = 1$   
 $n = 0, 1$   
 $pL + pH \times 256 = k + 3$   
 $32 \leq d \leq 126$

[Initial Value]  $n = 0$  ("0.pool.ntp.org") / Star Configuration setting

[Function] Set Star CloudPRNT NTP Server.

[Details]  $n$  specifies the NTP server.

n	NTP Server
0	Use Star NTP service
1	Use custom NTP server

When  $n=1$ ,  $d1 \dots dk$  specifies the custom NTP Server.

This command is enabled only when logged in with ESC GS ) N (fn=114) and the login password was changed with ESC GS ) N (fn=128).

The setting of this command is saved in the nonvolatile memory by ESC GS ) N (fn=112), and will be applied to operation after a hardware reset is executed.

### <Function 143> ESC GS ) N pL pH fn m (fn=143)

[Name]	Send Star CloudPRNT NTP Server								
[Code]	ASCII	ESC	GS	)	N	pL	pH	fn	m
	Hex.	1B	1D	29	4E	pL	pH	fn	m
	Decimal	27	29	41	78	pL	pH	fn	m

[Defined Area]  $pL = 2, pH = 0$   
 $fn = 143$   
 $m = 1$

[Initial Value] ---

[Function] Send Star CloudPRNT NTP Server.

The transmission is performed in the format below.

ESC GS ) N pL pH fn m n d1 ... dk LF NUL

n	NTP Server
0	Use Star NTP service
1	Use custom NTP server

When  $n=0$ ,  $d1 \dots dk$  is not added.

When  $n=1$ ,  $d1 \dots dk$  indicates the custom NTP Server.

This command is enabled only when logged in with ESC GS ) N (fn=114) and the login password was changed with ESC GS ) N (fn=128).

At other times, transmission is performed in the format below.

ESC GS ) N pL pH fn m LF NUL

### <Function 144> ESC GS ) N pL pH fn m n (fn=144)

[Name]	Set Star CloudPRNT TLS1.2 Cipher Suites Encryption Level									
[Code]	ASCII	ESC	GS	)	N	pL	pH	fn	m	n
	Hex.	1B	1D	29	4E	pL	pH	fn	m	n
	Decimal	27	29	41	78	pL	pH	fn	m	n

[Defined Area] pL = 3, pH = 0  
 fn = 144  
 m = 1  
 n = 0,1

[Initial Value] n = 0 / Star Configuration setting

[Function] Set Star CloudPRNT Cipher Suites Encryption Level.

[Details] n specifies the Star CloudPRNT Cipher Suites Encryption Level setting.

n	Cipher Suites Encryption Level
0	HIGH + MEDIUM
1	MEDIUM

This command is enabled only when logged in with ESC GS ) N (fn=114) and the login password was changed with ESC GS ) N (fn=128).

The setting of this command is saved in nonvolatile memory by ESC GS ) N (fn=112), and will be applied to operation after a hardware reset is executed.

### <Function 145> ESC GS ) N pL pH fn m (fn=145)

[Name]	Send Star CloudPRNT TLS1.2 Cipher Suites Encryption Level									
[Code]	ASCII	ESC	GS	)	N	pL	pH	fn	m	
	Hex.	1B	1D	29	4E	pL	pH	fn	m	
	Decimal	27	29	41	78	pL	pH	fn	m	

[Defined Area] pL = 2, pH = 0  
 fn = 145  
 m = 1

[Initial Value] ---

[Function] Send Star CloudPRNT Cipher Suites Encryption Level.

The transmission is performed in the format below.

ESC GS ) N pL pH fn m n LF NUL

n	Cipher Suites Encryption Level
0	HIGH + MEDIUM
1	MEDIUM

This command is enabled only when logged in with ESC GS ) N (fn=114) and the login password was changed with ESC GS ) N (fn=128).

At other times, transmission is performed in the format below.

ESC GS ) N pL pH fn m LF NUL

### <Function 146> ESC GS ) N pL pH fn m n (fn=146)

[Name] Set Star CloudPRNT TLS1.3  
 [Code] ASCII ESC GS ) N pL pH fn m n  
 Hex. 1B 1D 29 4E pL pH fn m n  
 Decimal 27 29 41 78 pL pH fn m n

[Defined Area] pL = 3, pH = 0  
 fn = 146  
 m = 1  
 n = 0,1

[Initial Value] n = 1 / Star Configuration setting

[Function] Set Star CloudPRNT TLS1.3.  
 n specifies the Star CloudPRNT TLS1.3 setting.

n	TLS1.3
0	Invalid
1	Valid

This command is enabled only when logged in with ESC GS ) N (fn=114) and the login password was changed with ESC GS ) N (fn=128).

The setting of this command is saved in nonvolatile memory by ESC GS ) N (fn=112), and will be applied to operation after a hardware reset is executed.

### <Function 147> ESC GS ) N pL pH fn m (fn=147)

[Name] Send Star CloudPRNT TLS1.3  
 [Code] ASCII ESC GS ) N pL pH fn m  
 Hex. 1B 1D 29 4E pL pH fn m  
 Decimal 27 29 41 78 pL pH fn m

[Defined Area] pL = 2, pH = 0  
 fn = 147  
 m = 1

[Initial Value] ---

[Function] Send Star CloudPRNT TLS1.3.  
 ESC GS ) N pL pH fn m n LF NUL

n	TLS1.3
0	Invalid
1	Valid

This command is enabled only when logged in with ESC GS ) N (fn=114) and the login password was changed with ESC GS ) N (fn=128).

At other times, transmission is performed in the format below.

ESC GS ) N pL pH fn m LF NUL

### <Function 150> ESC GS ) N pL pH fn m d1 ... dk (fn=150)

[Name]	Decrypt and send strings											
[Code]	ASCII	ESC	GS	)	N	pL	pH	fn	m	d1	...	dk
	Hex.	1B	1D	29	4E	pL	pH	fn	m	d1	...	dk
	Decimal	27	29	41	78	pL	pH	fn	m	d1	...	dk

[Defined Area]  $3 \leq pL + pH \times 256 = k + 2 \leq 1026$   
 $fn = 150$   
 $m = 1$   
 $30 \leq d \leq 39$  ("0"  $\leq d \leq$  "9"),  $65 \leq d \leq 90$  ("A"  $\leq d \leq$  "Z"),  $97 \leq d \leq 122$  ("a"  $\leq d \leq$  "z"),  $d = 43, 47, 61$  ( $d =$  "+", " ", "=")

[Initial Value] ---

[Function] Decrypt and send the encrypted string.  
 d1 ... dk specifies an encrypted string.

If the decryption is successful, it will be sent in the following format.

ESC GS ) N pL pH fn m d1 ... dk LF NUL

k Defined Area	d Defined Area
$1 \leq k \leq 767$	$30 \leq d \leq 39$ ("0" $\leq d \leq$ "9"), $65 \leq d \leq 90$ ("A" $\leq d \leq$ "Z"), $97 \leq d \leq 122$ ("a" $\leq d \leq$ "z"), $d = 45$ ( $d =$ "-")

d1 ... dk is the decrypted string.

If decryption fails, send in the following format.

ESC GS ) N pL pH fn m LF NUL

## <Function 152> ESC GS ) N pL pH fn m n1 n2 (fn=152)

[Name]	Set Star CloudPRNT HTTP Response Timeout										
[Code]	ASCII	ESC	GS	)	N	pL	pH	fn	m	n1	n2
	Hex.	1B	1D	29	4E	pL	pH	fn	m	n1	n2
	Decimal	27	29	41	78	pL	pH	fn	m	n1	n2
[Defined Area]	pL = 4, pH = 0 fn = 152 m = 1 n = 10, 20, 30, 40, 50, 60 (n = n1+n2×256)										
[Initial Value]	n1 = 60, n2 = 0/Star Configuration setting										
[Function]	Set Star CloudPRNT HTTP Response Timeout.										
[Details]	(n1 + n2 x 256) specifies the setting value (sec.) for Star CloudPRNT HTTP Response Timeout. This command is enabled only when logged in with ESC GS ) N (fn=114) and the login password was changed with ESC GS ) N (fn=128) and when n=1 (Enabled) is set by ESC GS ) N (fn=130).										

The setting of this command is stored in the nonvolatile memory by ESC GS ) N (fn=112), and will be applied to the operation after a hardware reset is executed.

## <Function 153> ESC GS ) N pL pH fn m (fn=153)

[Name]	Send Star CloudPRNT HTTP Response Timeout									
[Code]	ASCII	ESC	GS	)	N	pL	pH	fn	m	
	Hex.	1B	1D	29	4E	pL	pH	fn	m	
	Decimal	27	29	41	78	pL	pH	fn	m	
[Defined Area]	pL = 2, pH = 0 fn = 153 m = 1									
[Initial Value]	---									
[Function]	Send Star CloudPRNT HTTP Response Timeout. It is sent in the format below. ESC GS ) N pL pH fn m n1 n2 LF NUL									

(n1+n2×256) indicates the set time (sec.) for Star CloudPRNT HTTP Response Timeout.  
 Example: When the Star CloudPRNT HTTP Response Timeout setting is 60 sec.  
 n1=60, n2=0

This command is enabled only when logged in with ESC GS ) N (fn=114)  
 and the login password was changed with ESC GS ) N (fn=128).  
 At other times, transmission is performed in the format below.  
 ESC GS ) N pL pH fn m LF NUL

### 2.3.32. Command related to paper hold control

#### **ESC SYN DC3 n**

[Name] Paper hold control settings  
 [Code] ASCII ESC SYN DC3 n  
 Hex. 1B 16 13 n  
 Decimal 27 22 19 n

[Defined Area] n = 0, 1, 48, 49, 255  
 [Initial Value] Memory switch/Star Configuration setting  
 [Function] Sets paper hold control.

n	Paper hold control
0, 48	Invalid
1, 49	Valid
255	Memory switch/Star Configuration setting

When this is set to valid and printing is performed, printing is executed when the paper hold sensor detects that there is no paper.

When the paper hold sensor detects paper, the next printing is put on hold until the paper is removed.

The hold time can be set with the memory switch, and it is possible to select automatic cancel when timeout occurs.

When this is set to invalid and printing is performed, printing is executed regardless of the paper hold sensor status.

Set to invalid when performing continuous printing.

If unprinted data exists in the image buffer when this command is processed, the data is printed out first and then the

command is executed.

However when in page mode, printing is not executed even when unprinted data exists in the image buffer.

If printing is in progress when this command is processed, the printer waits for printing to stop before executing this command process.

This command setting is not initialized by the ESC @ command.

The setting by this command is initialized by printer reset.

Sending of this command is prohibited in raster mode.

## **ESC SYN DC4 n**

[Name] Paper hold status control settings  
 [Code] ASCII ESC SYN DC4 n  
 Hex. 1B 16 14 n  
 Decimal 27 22 20 n

[Defined Area] n = 0, 1, 48, 49, 255  
 [Initial Value] Memory switch / Star Configuration setting  
 [Function] Sets control for paper hold status.

n	Paper hold status control
0, 48	Invalid
1, 49	Valid
255	Memory switch/Star Configuration setting

When this is set to valid , it is possible to use the paper hold

When the paper hold sensor detects paper, the paper hold status is "paper present".

The hold time can be set with the memory switch , and it is possible to select automatic cancel of the "paper present"

status when timeout occurs.

When this is set to invalid , the paper hold sensor status is fixed at "no paper".

For information about the paper hold status, refer to Appendix 2 "Automatic status".

In line mode, if unprinted data exists in the image buffer, the data is printed out first and then this command is executed.

However printing is not executed in page mode.

If printing is in progress when this command is processed, the printer waits for printing to stop before executing this command process.

This command setting is not initialized by the ESC @ command.

The setting by this command is initialized by printer reset.

Sending of this command is prohibited in raster mode.

## **ESC GS ) s pL pH fn m (fn = 48)**

[Name] Send paper hold sensor installation data  
 [Code] ASCII ESC GS ) s pL pH fn m  
 Hex. 1B 1D 29 73 pL pH fn m  
 Decimal 27 29 41 115 pL pH fn m

[Defined Area] pL = 2, pH = 0  
 fn = 48  
 m = 1

[Function] Paper hold sensor installation data is sent in the format below.  
 <ESC> <GS> ")" "s" pL pH fn m n <LF> <NUL>

n	Installation data
0	Not installed
1	Installed

When outside the parameter definitions or when outside the specified sensor installation specifications, <ESC> <GS> ")" "s" <0> <0> fn <LF> <NUL> is returned.

This command is invalid in raster mode.

If unprinted data exists in the image buffer when this command is processed, the command is executed without executing printing first.



### 2.3.33. Spooler

#### **ESC GS ) SP p1 p2 p3 p4 fn [parameter]**

[Name] Spooler function

[Code] ASCII ESC GS ) SP p1 p2 p3 p4 fn [parameter]

Hex. 1B 1D 29 20 p1 p2 p3 p4 fn [parameter]

Decimal 27 29 41 32 p1 p2 p3 p4 fn [parameter]

[Function]

Executes processes related to the spooler.

- With p1, p2, p3, and p4, the parameter count after "fn" is specified as  $(p1 + p2 \times 256 + p3 \times 65536 + p4 \times 16777216)$  bytes.
- For [parameter], see the function specifications.

fn	Function No.	Function name
48	Function 48	Store print data in spooler
49	Function 49	Acquire job information with specified job ID
50	Function 50	Job information list (specified number of jobs)

**<Function 48>ESC GS ) SP p1 p2 p3 p4 fn r t1 t2 a1 a2 ad1...adk**

**d1 d2 d3 ... dn (fn = 48)**

[Name]	Store print data in spooler																			
[Code]	ASCII	ESC	GS	)	SP	p1	p2	p3	p4	fn	r	t1	t2	a1	a2	ad1	ad2	ad3	...	adk
																d1	d2	d3	...	dn
	Hex.	1B	1D	29	20	p1	p2	p3	p4	fn	r	t1	t2	a1	a2	ad1	ad2	ad3	...	adk
																d1	d2	d3	...	dn
	Decimal	27	29	41	32	p1	p2	p3	p4	fn	r	t1	t2	a1	a2	ad1	ad2	ad3	...	adk
																d1	d2	d3	...	dn

[Defined Area]

$0 \leq r \leq 1$   
 $0 \leq (t1 + t2 \times 256) \leq 3600$   
 $k = 0 \leq (a1 + a2 \times 256) \leq 1024$   
 $(p1+p2 \times 256+p3 \times 65536+p4 \times 16777216) \leq 8389638$   
 $1 \leq n \leq 8388608$   
 $n = (p1+p2 \times 256+p3 \times 65536+p4 \times 16777216) - (6 + k)$   
 $fn = 48$

[Function] Stores print data in spooler and starts printing via the spooler.

[Detail]

r specifies whether retry is valid or invalid (0: invalid, 1: valid).  
 If an error occurred during printing and retry is set to valid, then reprinting is executed after the error is canceled.  
 $t1 + t2 \times 256$  specifies the timeout time (Units: seconds, 0: No timeout, 1 to 3600).  
 $a1 + a2 \times 256$  specifies the ad data count k (0 - 1024 bytes).  
 d1 to dn send printing data.

After the command process, the printer sends the execution results in the format below.

ESC GS ) SP p1 p2 p3 p4 fn id1 id2 d1 d2

id1 id2	Job ID (id1 + id2 x 256)
---------	--------------------------

d1	
0	Receipt successful
1	Receipt failed

d2	
0	No error
1	Incorrect parameter
2	Insufficient spool buffer capacity
3	Spooler invalid

Do not send this command in d1 to dn. Operation is not guaranteed if it is sent.

Do not send the start/end document command (ESC GS ETX 3..., ESC GS ETX 4...) in d1 to dn. Operation is not guaranteed if it is sent.

## <Function 49>ESC GS ) SP p1 p2 p3 p4 fn id1 id2 (fn = 49)

[Name] Acquire specified job information

[Code] ASCII ESC GS ) SP p1 p2 p3 p4 fn id1 id2  
 Hex. 1B 1D 29 20 p1 p2 p3 p4 fn id1 id2  
 Decimal 27 29 41 32 p1 p2 p3 p4 fn id1 id2

[Defined Area] p1 = 3, p2 = 0, p3 = 0, p4 = 0, fn = 49

[Function] Sends job information for the job specified by the job ID.

[Detail]

The specified job information is sent in the format below.

ESC GS ) SP p1 p2 p3 p4 fn id1 id2 c s et1 et2 et3 et4 i r t1 t2 a1 a2 ad1 ... adk

id1 id2	Job ID (id1 + id2 x 256)
---------	--------------------------

c	
0	Specified job information exists
1	Specified job information does not exist
2	Spooler disabled

s	Status
0	Reserved
1	Received
2	Received: Timeout
3	Processing
4	Processing: Waiting for paper removal
5	Processing: Waiting for error reset
6	Printing successful
7	Printing failed: Error
8	Printing failed: Timeout
9	Printing failed: Power OFF: Reset

et1 ... et4	Elapsed time after receiving was completed (units: sec)
-------------	---

i	Job receiving interface
0	USB Printer
1	USB AOA
2	USB IAP
3	BT
4	LAN Raw Socket
5	Reserved
6	Reserved
7	Reserved
8	Reserved
9	Reserved
10	CloudPRNT
11	WebPRNT
12	SMCS
13	Reserved
14	Reserved
15	Reserved

r	Retry
0	Invalid
1	Valid

t1 t2	Timeout time (units: sec)
-------	---------------------------

a1 a2	Job additional information counter
-------	------------------------------------

ad1 ... adk	Job additional information $k = (a1 + a2 \times 256)$
-------------	---

When printer power is turned OFF from the power switch, the receiving time for the held job information is cleared.

The elapsed time for job information where the receiving time was cleared is sent as 0.

If the specified job does not exist, information is sent in the format below.

ESC GS ) SP p1 p2 p3 p4 fn id1 id2 c

## <Function 50>ESC GS ) SP p1 p2 p3 p4 fn n1 n2 (fn = 50)

[Name] Acquire the job information list

[Code] ASCII ESC GS ) SP p1 p2 p3 p4 fn id1 id2  
 Hex. 1B 1D 29 20 p1 p2 p3 p4 fn id1 id2  
 Decimal 27 29 41 32 p1 p2 p3 p4 fn id1 id2

[Defined Area] p1 = 3, p2 = 0, p3 = 0, p4 = 0, fn = 50

[Function] Sends job information for the specified number of jobs in the order of most recent receiving.

[Detail] The job information is sent in the format below.  
 ESC GS ) SP p1 p2 p3 p4 fn n1 n2 c [id1 id2 s et1 et2 et3 et4 i r t1 t2 a1 a2 ad1...adk]1 [id1 id2 s et1 et2 et3 et4 i r t1 t2 a1 a2 ad1...adk]2 [id1 id2 s ...

n1 and n2 send the number which exists when the existing number of jobs is less than the specified value.

c	
0	Reserved (spooler enabled)
1	Spooler disabled

id1 id2	Job ID (id1 + id2 x 256)
---------	--------------------------

s	Status
0	Reserved
1	Received
2	Received: Timeout
3	Processing
4	Processing: Waiting for paper removal
5	Processing: Waiting for error reset
6	Printing successful
7	Printing failed: Error
8	Printing failed: Timeout
9	Printing failed: Power OFF: Reset

et1 ... et4	Elapsed time after receiving was completed (units: sec)
-------------	---

i	Job receiving interface
0	USB Printer
1	USB AOA
2	USB IAP
3	BT
4	LAN Raw Socket
5	Reserved
6	Reserved
7	Reserved
8	Reserved
9	Reserved
10	CloudPRNT
11	WebPRNT
12	SMCS
13	Reserved
14	Reserved
15	Reserved

r	Retry
0	Invalid
1	Valid

t1 t2	Timeout time (units: sec)
-------	---------------------------

a1 a2	Job additional information counter
-------	------------------------------------

ad1 ... adk	Job additional information k = (a1 + a2 x 256)
-------------	---

If job information does not exist, information is sent in the format below.

ESC GS ) SP p1 p2 p3 p4 fn n1 n2 c ( n1=0, n2=0, c=0 )

### 2.3.34. Star Configuration Commands

#### **ESC GS ) # p1 p2 p3 p4 fn [parameter]**

[Name] Star Configuration function

[Code] ASCII ESC GS ) # p1 p2 p3 p4 fn [parameter]

Hex. 1B 1D 29 23 p1 p2 p3 p4 fn [parameter]

Decimal 27 29 41 35 p1 p2 p3 p4 fn [parameter]

[Function] Executes processes related to Star Configuration.

- With p1, p2, p3, and p4, the parameter count after "fn" is specified as  $(p1 + p2 \times 256 + p3 \times 65536 + p4 \times 16777216)$  bytes.
- For [parameter], see the function specifications.

fn	Function No.	Function name
48	Function 48	Register Star Configuration Json file
49	Function 49	Read Star Configuration Json file

## **<Function 48>ESC GS ) # p1 p2 p3 p4 fn d1 d2 ... dn (fn = 48)**

[Name] Register Star Configuration Json file

[Code] ASCII ESC GS ) # p1 p2 p3 p4 fn d1 d2 ... dn  
 Hex. 1B 1D 29 23 p1 p2 p3 p4 fn d1 d2 ... dn  
 Decimal 27 29 41 35 p1 p2 p3 p4 fn d1 d2 ... dn

[Defined Area]  $(p1 + p2 \times 256 + p3 \times 65536 + p4 \times 16777216) \leq 524289$   
 $fn = 48$   
 $n \leq 524288$

[Function] Register Star Configuration Json file and execute printer settings.  
 After the command process, the printer sends the execution results in the format below.  
 ESC GS ) # p1 p2 p3 p4 fn d1 d2

d1	Setting status
0	Setting successful
1	Setting failed

d2	
0	No error (response after settings are applied)
1	No error (response before settings are applied)
2	Reserved
3	Reserved
4	Reserved
5	Star Configuration file error
6	Star Configuration format error
7	Star Configuration parameter error
8	Reserved
9	Reserved
10	Incorrect password
11	Initial password has not been changed

When the Star Configuration “selfprint\_after\_writing” key is set to “enabled”, self-test printing is performed after the command process is executed.

When the correct password has been set with d1 to dn, the “password\_protected\_settings” block is also printed.



## <Function 49>ESC GS ) # p1 p2 p3 p4 fn d1 d2 ... dn (fn = 49)

[Name] Read Star Configuration Json file

[Code]	ASCII	ESC	GS	)	SP	p1	p2	p3	p4	fn	d1	d2	...	dn
	Hex.	1B	1D	29	20	p1	p2	p3	p4	fn	d1	d2	...	dn
	Decimal	27	29	41	32	p1	p2	p3	p4	fn	d1	d2	...	dn

[Defined Area]  $1 \leq (p1 + p2 \times 256 + p3 \times 65536 + p4 \times 16777216) \leq 32$   
 $fn = 49$   
 $0 \leq n \leq 31$   
 $0 \leq d \leq 255$  (However the defined area where the password can be used is  $32 \leq d \leq 126$ .)

[Function] Sends the Star Configuration Json file in the format below.  
 ESC GS ) # p1 p2 p3 p4 fn j1 j2 ... jk  
 When sending, p1, p2, p3, and p4 indicate the number of transmission bytes after fn.

When the password is not specified in d1 to dn, the JSON data except for the "password\_protected\_settings" block is sent.

When the correct password was specified in d1 to dn. the JSON data including the "password\_protected\_settings" block is sent.

If the specified password is incorrect, or if the password has not been changed from the initial value, the information key is added inside the password\_protected\_settings block, and that value indicates the reason why the password\_protected\_settings block cannot be read.

```
<Case of incorrect password>
password_protected_settings {
  information: "wrong_password"
}
```

```
<Case when the password has not been changed from the initial value>
password_protected_settings {
  information: "password_unchanged"
}
```

```
<When successful>
password_protected_settings {
  information: "success",
cloudprnt {
  service: true
  ...
}
...
}
```

### **3. CHARACTER CODE TABLES**

Refer to the separate "Character Code Tables".

## 4. APPENDIX

### 4.1. Appendix 1: Bar Code Specification Details

Refer to the dedicated manuals for characteristics and methods of use for each bar code symbol. This section describes precautions and methods for setting when printing with the printer.

Bar code widths are set for each bar code according to the mode. The following describes each mode and the dot counts. The user must ensure the specified printing position and quiet zone at the position where the bar code begins.

#### 4.1.1. Code 39

Code 39 represents numbers 0 to 9 and the letters of the alphabet from A to Z. These are the symbols most frequently used today in industry.

##### 1. Length of characters in each mode

Items	Mode 1	Mode 2	Mode 3	Mode 4	Mode 5	Mode 6	Mode 7	Mode 8	Mode 9
Narrow Element Width	2 dots	3 dots	4 dots	2 dots	3 dots	4 dots	2 dots	3 dots	4 dots
Wide Element Width	6 dots	9 dots	12 dots	5 dots	8 dots	10 dots	4 dots	6 dots	8 dots
Ratio	1:3	1:3	1:3	1:2.5	1:2.7	1:2.5	1:2	1:2	1:2
Character Spacing	2 dots	3 dots	4 dots	2 dots	3 dots	4 dots	2 dots	3 dots	4 dots
Length of 1 Character	4 mm	6 mm	8 mm	3.625 mm	5.625 mm	7.25 mm	3.25 mm	4.875 mm	6.5 mm

(\*) The length of 1 character includes the character spacing.

##### 2. Regulations

The start and stop bar code (\*) in Code 39 are automatically inserted.

#### 4.1.2. Interleaved 2 of 5

Interleaved 2 of 5 represents numbers 0 to 9. Higher density of characters is possible and with JIS and EAN, and printing to cardboard for distribution has been standardized.

##### 1. Narrow element width and length of symbols per 2 characters

Items	Mode 1	Mode 2	Mode 3	Mode 4	Mode 5	Mode 6	Mode 7	Mode 8	Mode 9
Narrow Element Width	2 dots	4 dots	6 dots	2 dots	4 dots	6 dots	2 dots	3 dots	4 dots
Wide Element Width	5 dots	10 dots	15 dots	4 dots	8 dots	12 dots	6 dots	9 dots	12 dots
Ratio	1:2.5	1:2.5	1:2.5	1:2	1:2	1:2	1:3	1:3	1:3
Length of 1 Character	4mm	8mm	12mm	3.5mm	7mm	10.5mm	4.5mm	6.75mm	9mm

##### 2. Regulations

- By selecting interleaved 2 of 5 bar code symbols, start and stop patterns are automatically inserted.
- When the bar code data digit count is odd, a zero is added to the highest value digit.
- Details conform to standards for AIM, USS-12/5, ANSI and JIS x 0502.

### 4.1.3. JAN/EAN/UPC

Used numbers, not only the bar code symbols, are controlled using JAN, EAN and UPC as shared common commercial codes. Mainly, they are used for supermarkets such as shops and grocery stores.

#### 1. Each mode and bar code width

Items		Mode 1	Mode 2	Mode 3
Module Width		2 dots	3 dots	4 dots
Bar code width (*)	JAN/EAN-8	16.75 mm	25.125 mm	33.5 mm
	JAN/EAN-13	23.75 mm	35.625 mm	47.5 mm
	UPC-A	23.75 mm	35.625 mm	47.5 mm
	UPC-E	12.75 mm	19.125 mm	25.5 mm

(\*) Includes the guard bar (left/right/center) but not the white space.

#### 2. Regulations

- JAN/EAN-8:

Data is in 7 or 8 digits. The command is ignored for others.

The check digit uses a modulus weight of 10/3 and is automatically applied.

When the calculated value and the numerical value of the 8<sup>th</sup> digit differ, the calculated value has priority.

- JAN/EAN-13:

Data is in 12 or 13 digits. The command is ignored for others.

The check digit uses a modulus weight of 10/3 and is automatically applied.

When the calculated value and the numerical value of the 13<sup>th</sup> digit differ, the calculated value has priority.

- UPC-A:

Data is in 11 or 12 digits. The command is ignored for others.

The check digit uses a modulus weight of 10/3 and is automatically applied.

When the calculated value and the numerical value of the 12<sup>th</sup> digit differ, the calculated value has priority.

- UPC-E:

Data is in 11 or 12 digits. The command is ignored for others.

The check digit uses a modulus weight of 10/3 and is automatically applied.

When the calculated value and the numerical value of the 12<sup>th</sup> digit differ, the calculated value has priority.

Data conversion to rectangles is automatic.

Data that cannot be shortened is processed as invalid data.

#### 4.1.4. Code 128

These are bar code symbols that can print ASCII 128 characters.

##### 1. Each module and module width

Items	Mode 1	Mode 2	Mode 3
Module Width	2 dots	3 dots	4 dots
Length of 1 Character (*)	2.75 mm	4.125 mm	5.5 mm

(\*) Start and stop bars not included.

##### 2. Regulations

When using <LF> with the command, control codes are not sent by the host PC, so the control codes are sent as data, as shown below.

- When sending the following data, it represents 2 characters set.
  - % (25H) represents %0 (25H 30H).
  - Control codes (00H to 1FH) represent 40H to 5FH applied behind %.
  - Control code (7FH) represents %5 (25H 35H).
  - Function codes represent 1 to 4 (31H to 34H) applied behind %.
  - Start codes represent 6 to 8 (36H to 38H) applied behind %.
- Stop code (SC)/Check character (CK) are automatically applied.
- When start code is omitted:
  - Uses START C when more than 2 digits continue after header.
  - Uses START A when initial data other than numbers are the control code.
  - Uses START B for other cases.

## • 2-character set code table

## &lt;Control Codes&gt;

<Control Codes>	
Code	Format
NUL 00H	%@ 25H 40H
SOH 01H	%A 25H 41H
STX 02H	%B 25H 42H
ETX 03H	%C 25H 43H
EOT 04H	%D 25H 44H
ENQ 05H	%E 25H 45H
ACK 06H	%F 25H 46H
BEL 07H	%G 25H 47H
BS 08H	%H 25H 48H
HT 09H	%I 25H 49H
LF 0AH	%J 25H 4AH
VT 0BH	%K 25H 4BH
FF 0CH	%L 25H 4CH
CR 0DH	%M 25H 4DH
SO 0EH	%N 25H 4EH
SI 0FH	%O 25H 4FH
DLE 10H	%P 25H 50H
DC1 11H	%Q 25H 51H
DC2 12H	%R 25H 52H
DC3 13H	%S 25H 53H
DC4 14H	%T 25H 54H
NAK 15H	%U 25H 55H
SYN 16H	%V 25H 56H
ETB 17H	%W 25H 57H
CAN 18H	%X 25H 58H
EM 19H	%Y 25H 59H
SUB 1AH	%Z 25H 5AH
ESC 1BH	%[ 25H 5BH
FS 1CH	% ¥25H 5CH
GS 1DH	%] 25H 5DH
RS 1EH	%^ 25H 5EH
US 1FH	%_ 25H 5FH
DEL 7FH	%5 25H 35H

<Control Codes>	
Code	Format
% 25H	%0 25H 30H

<Function Codes>	
Code	Format
FNC1	%1 25H 31H ☆
FNC2	%2 25H 32H ☆
FNC3	%3 25H 33H ☆
FNC4	%4 25H 34H ☆

<Start Codes>	
Code	Format
START A	%6 25H 36H ☆
START B	%7 25H 37H ☆
START C	%8 25H 38H ☆

#### 4.1.5. Code 93

##### 1. Each mode and module width

Items	Mode 1	Mode 2	Mode 3
Module Width	2 dots	3 dots	4 dots
Length of 1 Character (*)	2.25 mm	3.375 mm	4.5 mm

(\*) Start and stop bars not included.

##### 2. Regulations

- Start/stop codes are automatically applied.
- Check character (C, K) is automatically applied.
- 2 characters set expression conforms to Code 128.

However, items marked with a star are codes that can only be used with Code 128, and not with Code 93.

#### 4.1.6. NW7 (CODABAR)

NW7 normally uses either A through D as the start/stop codes and represents special symbols (- (minus sign)/\$ (dollar sign)/: (colon)// (slash)/. (period)/+ (plus sign) between 0 to 9.

These are used as carrier package marking bar codes, DPE (photo prints) and for medical related industries (USA).

##### 1. Length of 1 character in each mode

Items	Mode 1	Mode 2	Mode 3	Mode 4	Mode 5	Mode 6	Mode 7	Mode 8	Mode 9
Narrow Element Width	2	3	4	2	3	4	2	3	4
Wide Element Width	6	9	12	5	8	10	4	6	8
Ratio	1:3	1:3	1:3	1:2.5	1:2.7	1:2.5	1:2	1:2	1:2
Character Spacing (Dots)	2	3	4	2	3	4	2	3	4
Length of 1 Character (Normally mm) (Width mm)	3 3.5	4.5 5.25	6 7	2.75 3.125	4.25 5.125	5.5 6.25	2.5 2.75	3.75 4.125	5 5.5

- With NW7, lengths differ because narrow elements and wide elements are included according to the characters.
- Normal characters (narrow: 5, wide: 2) and numbers (0 to 9), - and \$
- Wide characters (narrow: 4, wide: 3) ,/.,.,+, A to D
- Character spaces are included in 1 character length.

#### 4.1.7. GS1-128

##### Basic structure of data

Start character	FNC1	AI	Data	Check digit A	Check digit B	Stop character
Added automatically		(d1...dn)			Added automatically	

##### Connection structure of data

Start character	FNC1	AI	Data	Check digit A	FNC1	AI	Data	Check digit A	Check digit B	Stop character
Added automatically		(d1...dn)						Added automatically		

The following four special characters operate as shown below.

Special Characters			
Characters	Hex.	Decimal	
SP	20	32	The first SP after d1 is the data division identifier for identifying (AI). The SP is reflected by the HRI but is not included in the encoding data.
(	28	40	“(“ is reflected by the HRI. This is useful when using “(,)” to highlight the AI. It is not included in encoding data.
)	29	41	The first “)” after d1 is the data division identifier for identifying (AI). The “)” is reflected by the HRI but is not included in the encoding data.
*	2A	42	The check digit calculated by modulus 10 is inserted automatically at the position specified in “*”. The check digit is reflected in the HRI instead of the “*”.

Data added automatically is not entered in the HRI characters.

Special HRI characters are processed as shown below.

- Start characters (CODE A, CODE B, CODE C) are not printed in HRI characters.
- SP is used for HRI characters for function characters (FNC1 and FNC3) and control characters (00H to 1FH and 7FH).
- HRI characters for SP and “(,)” are printed as they are.
- The check digit is printed in the “\*” position.

The available data ranges for each code set (CODE A, CODE B, CODE C) are shown in the following table.

Bar code data for special characters (FNC1, FNC3) or “(, )”, “\*”, “{“ sends double-byte characters as shown in the following table.



d		Character		
Hex.	Decimal	CODE A	CODE B	CODE C
00	0	NUL		00
01	1	SOH		01
02	2	STX		02
03	3	ETX		03
04	4	EOT		04
05	5	ENQ		05
06	6	ACK		06
07	7	BEL		07
08	8	BS		08
09	9	HT		09
0A	10	LF		10
0B	11	VT		11
0C	12	FF		12
0D	13	CR		13
0E	14	SO		14
0F	15	SI		15
10	16	DLE		16
11	17	DC1		17
12	18	DC2		18
13	19	DC3		19
14	20	DC4		20
15	21	NAK		21
16	22	SYN		22
17	23	ETB		23
18	24	CAN		24
19	25	EM		25
1A	26	SUB		26
1B	27	ESC		27
1C	28	FS		28
1D	29	GS		29
7B, 1E	123, 30	RS		30
1F	31	US		31
20	32			
21	33	!	!	33
22	34	"	"	34
23	35	#	#	35
24	36	\$	\$	36

d		Character		
Hex.	Decimal	CODE A	CODE B	CODE C
25	37	%	%	37
26	38	&	&	38
27	39	'	'	39
7B, 28	123, 40	(	(	40
7B, 29	123, 41	)	)	41
7B, 2A	123, 42	*	*	42
2B	43	+	+	43
2C	44	,	,	44
2D	45	-	-	45
2E	46	.	.	46
2F	47	/	/	47
30	48	0	0	48
31	49	1	1	49
32	50	2	2	50
33	51	3	3	51
34	52	4	4	52
35	53	5	5	53
36	54	6	6	54
37	55	7	7	55
38	56	8	8	56
39	57	9	9	57
3A	58	:	:	58
3B	59	;	;	59
3C	60	<	<	60
3D	61	=	=	61
3E	62	>	>	62
3F	63	?	?	63
40	64	@	@	64
41	65	A	A	65
42	66	B	B	66
43	67	C	C	67
44	68	D	D	68
45	69	E	E	69
46	70	F	F	70
47	71	G	G	71
48	72	H	H	72
49	73	I	I	73

d		Character		
Hex.	Decimal	CODE A	CODE B	CODE C
4A	74	J	J	74
4B	75	K	K	75
4C	76	L	L	76
4D	77	M	M	77
4E	78	N	N	78
4F	79	O	O	79
50	80	P	P	80
51	81	Q	Q	81
52	82	R	R	82
53	83	S	S	83
54	84	T	T	84
55	85	U	U	85
56	86	V	V	86
57	87	W	W	87
58	88	X	X	88
59	89	Y	Y	89
5A	90	Z	Z	90
5B	91	[	[	91
5C	92	¥	¥	92
5D	93	]	]	93
5E	94	^	^	94
5F	95	_	_	95
60	96	/	`	96
61	97	/	a	97
62	98	/	b	98
63	99	/	c	99
64	100	/	d	/
65	101	/	e	/
66	102	/	f	/
67	103	/	g	/
68	104	/	h	/
69	105	/	i	/
6A	106	/	j	/
6B	107	/	k	/
6C	108	/	l	/
6D	109	/	m	/
6E	110	/	n	/

d		Character		
Hex.	Decimal	CODE A	CODE B	CODE C
6F	111	/	o	/
70	112	/	p	/
71	113	/	q	/
72	114	/	r	/
73	115	/	s	/
74	116	/	t	/
75	117	/	u	/
76	118	/	v	/
77	119	/	w	/
78	120	/	x	/
79	121	/	y	/
7A	122	/	z	/
7B, 7B	123, 123	/	{	/
7C	124	/		/
7D	125	/	}	/
7E	126	/	~	/
7F	127	/	DEL	/

d		Special Characters		
Hex.	Decimal	CODE A	CODE B	CODE C
7B, 31	123, 49	FNC1	FNC1	FNC1
7B, 33	123, 51	FNC3	FNC3	/
20	32	SP	SP	SP
28	40	(	(	(
29	41	)	)	)
2A	42	*	*	*

#### 4.1.8. GS1 Databar Omnidirectional

Sends 13 digits of data except for AI (application identifiers) and check digits.

AI ("01") is added automatically.

One check digit is added automatically.

When HRI printing is enabled, 18 digits of [{"(01)", (d1...d13), check digit}] are printed by the HRI.

When the setting for the bar code height is smaller than [module width x33], the bar code height is printed at the [module width x33]. (Except for HRI heights)

#### 4.1.9. GS1 Databar Truncated

Sends 13 digits of data except for AI (application identifiers) and check digits.

AI ("01") is added automatically.

One check digit is added automatically.

When HRI printing is enabled, 18 digits of [{"(01)", (d1...d13), check digit}] are printed by the HRI.

When the setting for the bar code height is smaller than [module width x13], the bar code height is printed at the [module width x13]. (Except for HRI heights)

#### 4.1.10. GS1 Databar Limited

Sends 13 digits of data except for AI (application identifiers) and check digits.

When HRI printing is enabled, 18 digits of [{"(01)", (d1...d13), check digit}] are printed by the HRI.

When the setting for the bar code height is smaller than [module width x10], the bar code height is printed at the [module width x10]. (Except for HRI heights)

#### 4.1.11. GS1 Databar Expanded

When sending special characters (FNC1) or ("(", ")"), the following double-byte data is sent.

Data	Send data		
	ASCII	Hex.	Decimal
FNC1	{ + 1	7B + 31	123 + 49
(	{ + (	7B + 28	123 + 40
)	{ + )	7B + 29	123 + 41

The special character ("(", ")") is processed as shown in the following table.

Special characters			
character	Hex.	Decimal	
(	28	40	"(" is entered in the HRI character. AI can be highlighted by using in combination with ")". ")" is not encoded.
)	29	41	The first ")" after d1 is handled as an AI and the data divider. ")" is entered in the HRI character. ")" is not encoded.

When HRI character printing is enabled, special characters are handled in the HRI as shown below.

- Control characters (FNC1) are not printed.
- Special characters ("(", ")") are printed.
- Bar code data [{"(" + ("(", ")")}] is printed as ("(", ")").

When the setting for the bar code height is smaller than [module width x34], the bar code height is printed at the [module width x34]. (Except for HRI heights)

## 4.2. Appendix 2: Status Specifications

### 4.2.1. Automatic Status

Automatic status is a group of states that are automatically returned from the printer to the host when the printer's status has changed. Automatic status is composed of "Header-1," "Header-2" and "plurality of bytes of the printer status and is continuously returned to the host. The host always uses an identifying method to identify the data for every byte received. (It is possible that Xon/Xoff codes are exceptionally mixed in the automatic status in the Xon/Xoff mode (when using a serial I/F), so it is necessary to consider that on the receiving side.)

The initial value for automatic status enabled/disabled is determined by the DIP SW or memory switch.

It is possible to change the conditions using the ESC RS a n command after turning ON the power.

Also, it is possible to get the automatic status using the ESC ACK SOH command, regardless of the valid/invalid conditions.

#### 1. Header-1

Header-1 is the 1 byte length information transmitted at the head of the automatic status.

The table below shows the composition of the Header-1. Header-1 represents the entire status transmission byte count, including Header-1, using bit 1 to bit 3 and bit 5. The host gets the transmission byte information and always receives the status data for that amount transmission bytes. For reference, the table below shows the relationship of actual transmission bytes and the Header-1. Because the bit 0 that indicates that this is the Header-1 is normally 1 (the second byte and beyond is 0), to detect the Header-1, it is acceptable to verify that bit 0 is 1 and bit 4 = 0 for this data. Note that bit 6 is for future expansion and is ignored in host-side processes.

<Header-1 (First Byte)>

Bit	Contents	Status		Model Compatability										
		"0"	"1"	mPOP	L Series	S,T Series	mC-Print3 (1st Gen.)	mC-Print2	TSP100IV TSP100IV SK	mC-Label3	mC-Print3 (2nd Gen.)	BSC10II		
7	Fixed at "0"		-	-	-	-	-	-	-	-	-	-	-	
6	Printer Status Byte Count		-	-	-	-	-	-	-	-	OK	-	-	
5	Printer Status Byte Count			OK	OK	OK	OK	OK	OK	OK	OK	OK	OK	
4	Fixed at "0"		-	-	-	-	-	-	-	-	-	-	-	
3	Printer Status Byte Count			OK	OK	OK	OK	OK	OK	OK	OK	OK	OK	
2	Printer Status Byte Count			OK	OK	OK	OK	OK	OK	OK	OK	OK	OK	
1	Printer Status Byte Count			OK	OK	OK	OK	OK	OK	OK	OK	OK	OK	
0	Fixed at "1"	-		-	-	-	-	-	-	-	-	-	-	

Actual transmission byte count and header-1 table

Transmission Byte Count n ( $7 \leq n \leq 15$ )	Header-1	Model
7	00001111B (0F Hex)	
8	00100001B (21 Hex)	
9	00100011B (23 Hex)	SM-L Series SM-S, T Series
10	00100101B (25 Hex)	
11	00100111B (27 Hex)	mPOP (FW Ver1.0 to 3.1)
12	00101001B (29 Hex)	mC-Print2 mC-Print3 (1st Generation) mPOP (FW Ver4.0 or later)
13	00101011B (2B Hex)	
14	00101101B (2D Hex)	
15	00101111B (2F Hex)	TSP100IV TSP100IV SK mC-Print3 (2nd Generation) BSC10II
16	01000001B(41 Hex)	mC-Label3

## 2. Header-2

Header-2 is the 1 byte length information transmitted from the second byte of the automatic status. The table below shows the composition of the Header-2.

Header-2 represents the automatic status version (called automatic status version below) using bit 1 to bit 3 and bit 5.

For reference, the table below shows the relationship of actual version bytes and the Header-2. The automatic status version will be used as new information is added to the printer status bit positions that were empty, by adding new functions in the future.

When the host does not control the automatic status version, it is acceptable to ignore Header-2 received.

### <Header-2 (Second Byte)>

Bit	Contents	Status		Model Compatability										
		"0"	"1"	mPOP	L Series	S, T Series	mC-Print3 (1st Gen.)	mC-Print2	TSP100IV TSP100IV SK	mC-Label3	mC-Print3 (2nd Gen.)	BSC10II		
7	ASB Status Expansion	No Expansion	Expansion	-	-	-	-	-	-	-	-	-	-	
6	Not Used (Fixed at "0")		-	-	-	-	-	-	-	-	-	-	-	
5	Version No.			OK	OK	OK	OK	OK	OK	OK	OK	OK	OK	
4	Fixed at "0"		-	-	-	-	-	-	-	-	-	-	-	
3	Version No.			OK	OK	OK	OK	OK	OK	OK	OK	OK	OK	
2	Version No.			OK	OK	OK	OK	OK	OK	OK	OK	OK	OK	
1	Version No.			OK	OK	OK	OK	OK	OK	OK	OK	OK	OK	
0	Fixed at "0"		-	-	-	-	-	-	-	-	-	-	-	

Actual automatic status version and header -2 table

Version No. n	Header-2
1	0000010B (02 Hex)
2	0000100B (04 Hex)
3	0000110B (06 Hex)
4	00001000B (08 Hex)
5	00001010B (0A Hex)
6	00001100B (0C Hex)
7	00001110B (0E Hex)
8	00100000B (20 Hex)
9	00100010B (22 Hex)
•	•
•	•
•	•
30	01101100B (6C Hex)
31	01101110B (6E Hex)

## Printer Status Version

Model Name	Version No.	Status
SM-L Series SM-S, T Series	3 (06Hex)	Up to printer status 7 (9th byte) loaded
mPOP (FW Ver1.0 to 3.1)	4 (08 Hex)	Up to printer status 9 (11th byte) loaded
mC-Print2 mC-Print3 (1st Generation) mPOP (FW Ver4.0 or later)	5 (0A Hex)	Up to printer status 10 (12th byte) loaded
TSP100IV TSP100IV SK mC-Print3 (2nd Generation) BSC10II	6 (0CHex)	Up to printer status 13 (15th byte) loaded
mC-Label3	7(0EHex)	Up to printer status 14 (16th byte) loaded

### 3. Printer Status

Printer status is the status of the printer sent from the third byte of the automatic status.

Printer status is returned for (transmitted byte count - 2 in Header-1).

Printer status is always updated for new information. (No log exists.) The following shows the composition of the status.

#### <Printer status 1: Printer status (Third Byte)>

Bit	Contents	Status		Model Compatability										
		"0"	"1"	mPOP	L Series	S, T Series	mC-Print3 (1st Gen.)	mC-Print2	TSP100IV TSP100IV SK	mC-Label3	mC-Print3 (2nd Gen.)	BSC10II		
7	Fixed at "0"		-	-	-	-	-	-	-	-	-	-	-	
6	OFFLINE By Switch Input	No	Yes	-	-	-	-	-	-	-	-	-	-	
5	Cover Status	Closed	Open	OK	OK	OK	OK	OK	OK	OK	OK	OK	OK	
4	Fixed at "0"		-	-	-	-	-	-	-	-	-	-	-	
3	ONLINE/OFFLINE Status	ONLINE	OFFLINE	OK	OK	OK	OK	OK	OK	OK	OK	OK	OK	
2	Drawer status	Closed	Open	OK	No	No	OK	OK	OK	OK	OK	OK	OK	
1	<ETB> Command	Not Executed	Executed	OK	OK	OK	OK	OK	OK	OK	OK	OK	OK	
0	Fixed at "0"		-	-	-	-	-	-	-	-	-	-	-	

- <ETB> Command

Cleared when received at the host (by clearing bit 1 to 0, automatic status is not targeted to occur).

- CashDrawer Status (Model limitation)

For mPOP, the restrictions differ as follows depending on the FW version.

<F/W Ver.1.0 to Ver.1.3 > Indicates the state of the internal drawer.

<F/W Ver.2.0 or later> If the hardware supports DK ports, OPEN indicates that either the internal drawer or external drawer are open, while CLOSE indicates that both are closed.

If the hardware does not support DK ports, it indicates the state of the internal drawer.



## &lt;Printer status 2: Error Information (Fourth Byte)&gt;

Bit	Contents	Status		Model Compatability									
		"0"	"1"	mPOP	L Series	S, T Series	mC-Print3 (1st Gen.)	mC-Print2	TSP100IV TSP100IV SK	mC-Label3	mC-Print3 (2nd Gen.)	BSC10II	
7	Fixed at "0"		-	-	-	-	-	-	-	-	-	-	-
6	Stopped by high head temperature	Not stopped	Stopped	OK	OK	OK	OK	OK	OK	OK	OK	OK	OK
5	Non-recoverable Error	No	Yes	OK	OK	No	OK	OK	OK	OK	OK	OK	OK
4	Fixed at "0"		-	-	-	-	-	-	-	-	-	-	-
3	Auto-cutter Error	No	Yes	OK	No	No	OK	OK	OK	OK	OK	OK	OK
2	Mechanical Error	No	Yes	No	No	No	No	No	No	No	No	No	No
	Head Thermistor Error	No	Yes	OK	No	No	OK	OK	OK	OK	OK	OK	OK
1	Not Used (Fixed at "0")			-	-	-	-	-	-	-	-	-	-
0	Fixed at "0"		-	-	-	-	-	-	-	-	-	-	-

## &lt;Printer status 3: Error Information (Fifth Byte)&gt;

Bit	Contents	Status		Model Compatability									
		"0"	"1"	mPOP	L Series	S, T Series	mC-Print3 (1st Gen.)	mC-Print2	TSP100IV TSP100IV SK	mC-Label3	mC-Print3 (2nd Gen.)	BSC10II	
7	Fixed at "0"		-	-	-	-	-	-	-	-	-	-	-
6	Reserved (Fixed at "0")		-	-	-	-	-	-	-	-	-	-	-
5	Reserved (Fixed at "0")		-	-	-	-	-	-	-	-	-	-	-
4	Fixed at "0"		-	-	-	-	-	-	-	-	-	-	-
3	BM Error	No	Yes	No	OK	OK	No	No	No	OK	No	No	
2	Paper Jam Error	No	Yes	-	-	-	-	-	-	(TSP100IV) FW Ver2.1 or later (TSP100IV SK)	OK	-	-
1	Electric Voltage Error	No	Yes	OK	No	No	OK	OK	OK	OK	OK	OK	OK
0	Fixed at "0"		-	-	-	-	-	-	-	-	-	-	-

## • BM Error

On models that use a common PE and BM sensor, if a continuous error is detected beyond a determined amount, it indicates not a black mark error, but a paper out error.

## &lt;Printer status 4: Sensor Information (Sixth Byte)&gt;

Bit	Contents	Status		Model Compatability									
		"0"	"1"	mPOP	L Series	S, T Series	mC-Print3 (1st Gen.)	mC-Print2	TSP100IV TSP100IV SK	mC-Label3	mC-Print3 (2nd Gen.)	BSC10II	
7	Fixed at "0"		-	-	-	-	-	-	-	-	-	-	-
6	Not Used (Fixed at "0")		-	-	-	-	-	-	-	-	-	-	-
5	Paper Position Error	No	Yes	-	-	-	-	-	-	-	OK	-	-
4	Fixed at "0"		-	-	-	-	-	-	-	-	-	-	-
3	Paper end	Paper	No Paper	OK	OK	OK	OK	OK	OK	OK	OK	OK	OK
2	Paper Near-end (Inner Side)	Paper	No Paper	No	No	No	OK	No	No	No	No	OK	No
1	Paper Near-end (Outer Side)	Paper	No Paper	-	-	-	-	-	-	-	-	-	-
0	Fixed at "0"		-	-	-	-	-	-	-	-	-	-	-

## &lt;Printer status 5: Sensor Information (Seventh Byte)&gt;

Bit	Contents	Status		Model Compatability									
		"0"	"1"	mPOP	L Series	S, T Series	mC-Print3 (1st Gen.)	mC-Print2	TSP100IV TSP100IV SK	mC-Label3	mC-Print3 (2nd Gen.)	BSC10II	
7	Fixed at "0"		-	-	-	-	-	-	-	-	-	-	-
6	Not Used (Fixed at "0")		-	-	-	-	-	-	-	-	-	-	-
5	Not Used (Fixed at "0")		-	-	-	-	-	-	-	-	-	-	-
4	Fixed at "0"		-	-	-	-	-	-	-	-	-	-	-
3	Reserved (Fixed at "0")		-	-	-	-	-	-	-	-	-	-	-
2	Reserved (Fixed at "0")		-	-	-	-	-	-	-	-	-	-	-
1	Paper Hold Sensor	No Paper	Paper	-	-	-	-	-	-	- (TSP100IV) OK (TSP100IV SK)	OK	-	-
0	Fixed at "0"		-	-	-	-	-	-	-	-	-	-	-

## &lt;Printer status 6: ETB Counter (Eighth Byte)&gt;

Bit	Contents	Status		Model Compatability									
		"0"	"1"	mPOP	L Series	S, T Series	mC-Print3 (1st Gen.)	mC-Print2	TSP100IV TSP100IV SK	mC-Label3	mC-Print3 (2nd Gen.)	BSC10II	
7	Fixed at 0		-	-	-	-	-	-	-	-	-	-	-
6	ETB Counter Bit-4			OK	OK	OK	OK	OK	OK	OK	OK	OK	OK
5	ETB Counter Bit-3			OK	OK	OK	OK	OK	OK	OK	OK	OK	OK
4	Fixed at 0		-	-	-	-	-	-	-	-	-	-	-
3	ETB Counter Bit-2			OK	OK	OK	OK	OK	OK	OK	OK	OK	OK
2	ETB Counter Bit-1			OK	OK	OK	OK	OK	OK	OK	OK	OK	OK
1	ETB Counter Bit-0			OK	OK	OK	OK	OK	OK	OK	OK	OK	OK
0	Fixed at 0		-	-	-	-	-	-	-	-	-	-	-

## (\*) ETB Counter

This counter is the 5 bit ETB counter.

(It counts from 0 to 31. When the counter overflows, it counts up from 31 to 0.)

This counter is incremented by 1 using the <ETB> command.

The ETB counter is initialized by the following commands. When doing so, ASB ETB status is cleared.

However, when initializing the ETB counter, ASB is not transmitted.

## &lt;ETB Counter Initialization Commands&gt;

- <ESC> <RS> E n : ETB Counter Initialization

## &lt;Printer status 7: Position for Presenter Paper (Ninth Byte)&gt;

Bit	Contents	Status		Model Compatability									
		"0"	"1"	mPOP	L Series	S, T Series	mC-Print3 (1st Gen.)	mC-Print2	TSP100IV TSP100IV SK	mC-Label3	mC-Print3 (2nd Gen.)	BSC10II	
7	Fixed at "0"		-	-	-	-	-	-	-	-	-	-	-
6	Not Used (Fixed at "0")		-	-	-	-	-	-	-	-	-	-	-
5	Not Used (Fixed at "0")		-	-	-	-	-	-	-	-	-	-	-
4	Fixed at "0"		-	-	-	-	-	-	-	-	-	-	-
3	Reserved (Fixed at "0")		-	-	-	-	-	-	-	-	-	-	-
2	Reserved (Fixed at "0")		-	-	-	-	-	-	-	-	-	-	-
1	Reserved (Fixed at "0")		-	-	-	-	-	-	-	-	-	-	-
0	Fixed at "0"		-	-	-	-	-	-	-	-	-	-	-

- This status is valid only on models provided with a presenter.

## &lt;Printer status 8: Error Information (Tenth Byte)&gt;

Bit	Contents	Status		Model Compatability									
		"0"	"1"	mPOP	L Series	S, T Series	mC-Print3 (1st Gen.)	mC-Print2	TSP100IV TSP100IV SK	mC-Label3	mC-Print3 (2nd Gen.)	BSC10II	
7	Fixed at "0"		-	-	-	-	-	-	-	-	-	-	-
6	Stopped printing due to high PCB temperature	No Stop	Stop	No	No	No	OK	OK	OK	OK	OK	OK	OK
5	Drawer open error	No error	Error	OK	No	No	No	No	No	No	No	No	No
4	Fixed at "0"		-	-	-	-	-	-	-	-	-	-	-
3	FLASH access error	No error	Error	OK	No	No	OK	OK	OK	OK	OK	OK	OK
2	EEPROM access error	No error	Error	OK	No	No	OK	OK	OK	OK	OK	OK	OK
1	SRAM access error	No error	Error	No	No	No	No	No	No	No	No	No	No
0	Fixed at "0"		-	-	-	-	-	-	-	-	-	-	-

## &lt;Printer status 9: Error Information (11th Byte)&gt;

Bit	Contents	Status		Model Compatability									
		"0"	"1"	mPOP	L Series	S, T Series	mC-Print3 (1st Gen.)	mC-Print2	TSP100IV TSP100IV SK	mC-Label3	mC-Print3 (2nd Gen.)	BSC10II	
7	Fixed at "0"		-	-	-	-	-	-	-	-	-	-	-
6	PCB thermistor error	No error	Error	No	No	No	No	No	No	No	No	No	No
5	Sensor adjustment error	No error	Error	No	No	No	No	No	No	No	No	No	No
4	Fixed at "0"		-	-	-	-	-	-	-	-	-	-	-
3	Printer Unit status	Closed	Open	OK	No	No	No	No	No	No	No	No	No
2	Spooler buffer full (When spooler command is not used)	No error	Error	-	-	-	-	-	-	-	OK	-	-
1	Reserved (Fixed at "0")		-	-	-	-	-	-	-	-	-	-	-
0	Fixed at "0"		-	-	-	-	-	-	-	-	-	-	-

## &lt;Printer status 10: I/F Information (12th Byte)&gt;

Bit	Contents	Status		Model Compatibility									
		"0"	"1"	mPOP	L Series	S, T Series	mC-Print3 (1st Gen.)	mC-Print2	TSP100IV TSP100IV SK	mC-Label3	mC-Print3 (2nd Gen.)	BSC10II	
7	Fixed at "0"		-	-	-	-	-	-	-	-	-	-	-
6	During communication I/F		-	Fixed at "0"	Fixed at "0"	Fixed at "0"	Fixed at "0"	Fixed at "0"	Fixed at "0"	Fixed at "0"	OK	OK	OK
5	During communication I/F		-	Fixed at "0"	Fixed at "0"	Fixed at "0"	Fixed at "0"	Fixed at "0"	Fixed at "0"	Fixed at "0"	OK	OK	OK
4	Fixed at "0"		-	-	-	-	-	-	-	-	-	-	-
3	During communication I/F		-	OK FW Ver.4.0 or later	No	No	OK	OK	OK	OK	OK	OK	OK
2	During communication I/F		-	OK FW Ver.4.0 or later	No	No	OK	OK	OK	OK	OK	OK	OK
1	During communication I/F		-	OK FW Ver.4.0 or later	No	No	OK	OK	OK	OK	OK	OK	OK
0	Fixed at "0"		-	-	-	-	-	-	-	-	-	-	-

## During communication I/F

Bit6	Bit5	Bit3	Bit2	Bit1	During communication I/F (broad category)	During communication I/F	
0	0	0	0	0	USB	USB-B	USB-B
0	0	0	0	1	USB	USB (iOS)	USB (iOS)
0	0	0	1	0	Bluetooth	Bluetooth	Bluetooth
0	0	0	1	1	LAN	Ethernet	Ethernet
0	0	1	0	0	USB	USB-C (Windows/Android USB PD not supported)	USB-C (Printer Class USB PD supported)
0	0	1	0	1	USB	USB-C (Windows USB PD not supported)	USB-C(Printer Class PD not supported)
0	0	1	1	0	USB	USB-A (Android)	USB-A (AOA)
0	0	1	1	1	USB	USB (iOS)	USB (iOS)
0	1	0	0	0	USB	USB-C (Android USB PD not supported)	USB-C (AOA USB PD not supported)
		...			Reserved	Reserved	
1	1	1	1	1	Serial	Serial	

## &lt;Printer status 11: Drawer Information (13th Byte)&gt;

Bit	Contents	Status		Model Compatability									
		"0"	"1"	mPOP	L Series	S, T Series	mC-Print3 (1st Gen.)	mC-Print2	TSP100IV TSP100IV SK	mC-Label3	mC-Print3 (2nd Gen.)	BSC10II	
7	Fixed at "0"	—	—	-	-	-	-	-	-	-	-	-	-
6	Cash Drawer Open method	Manual	Command	-	-	-	-	-	OK	OK	OK	OK	
5	Cash Drawer Status	CLOSE	OPEN	-	-	-	-	-	OK	OK	OK	OK	
4	Fixed at "0"	-	-	-	-	-	-	-	-	-	-	-	
3	Cash Drawer Open method	Manual	Command	-	-	-	-	-	OK	OK	OK	OK	
2	Cash Drawer Status	CLOSE	OPEN	-	-	-	-	-	OK	OK	OK	OK	
1	Reserved (Fixed at "0")	-	-	-	-	-	-	-	-	-	-	-	
0	Fixed at "0"	-	-	-	-	-	-	-	-	-	-	-	

- < Cash Drawer Open method > and < Cash Drawer Status >

By checking the status, you can see what caused the cash drawer to be opened.

Bit6 Bit3	Bit5 Bit2	Cash Drawer status & control method
0	0	CLOSE
0	1	OPEN by hand
1	0	Does not occur
1	1	OPEN by Command

Notes) - However if the cash door is opened or closed by hand while the cash drawer is being operated by a command, the status may become "Unstable". Therefore do not open or close the cash drawer by hand while the cash drawer is being operated by a command.

- Cash drawer open method and cash drawer status (Bit 6, Bit 5) and (Bit 3, Bit 2) are same values.

## &lt;Printer status 12: Drawer Information (14th Byte)&gt;

Bit	Contents	Status		Model Compatability									
		"0"	"1"	mPOP	L Series	S, T Series	mC-Print3 (1st Gen.)	mC-Print2	TSP100IV TSP100IV SK	mC-Label3	mC-Print3 (2nd Gen.)	BSC10II	
7	Fixed at "0"	-	-	-	-	-	-	-	-	-	-	-	-
6	Reserved (Fixed at "0")	-	-	-	-	-	-	-	-	-	-	-	-
5	Reserved (Fixed at "0")	-	-	-	-	-	-	-	-	-	-	-	-
4	Fixed at "0"	-	-	-	-	-	-	-	-	-	-	-	-
3	Reserved (Fixed at "0")	-	-	-	-	-	-	-	-	-	-	-	-
2	Reserved (Fixed at "0")	-	-	-	-	-	-	-	-	-	-	-	-
1	Reserved (Fixed at "0")	-	-	-	-	-	-	-	-	-	-	-	-
0	Fixed at "0"	-	-	-	-	-	-	-	-	-	-	-	-

## &lt;Printer status 13: External Device Information (15th Byte)&gt;

Bit	Contents	Status		Model Compatability									
		"0"	"1"	mPOP	L Series	S, T Series	mC-Print3 (1st Gen.)	mC-Print2	TSP100IV TSP100IV SK	mC-Label3	mC-Print3 (2nd Gen.)	BSC10II	
7	Fixed at "0"	-	-	-	-	-	-	-	-	-	-	-	-
6	Connection status of External device 1	disconnected	Connected	-	-	-	-	-	OK	OK	OK	OK	
5	Connection status of External device 2	disconnected	Connected	-	-	-	-	-	OK	OK	OK	OK	
4	Fixed at "0"	-	-	-	-	-	-	-	-	-	-	-	-
3	Reserved (Fixed at "0")	-	-	-	-	-	-	-	-	-	-	-	-
2	Reserved (Fixed at "0")	-	-	-	-	-	-	-	-	-	-	-	-
1	Reserved (Fixed at "0")	-	-	-	-	-	-	-	-	-	-	-	-
0	Fixed at "0"	-	-	-	-	-	-	-	-	-	-	-	-

## &lt;Printer status 14 (16th Byte)&gt;

Bit	Contents	Status		Model Compatability										
		"0"	"1"	mPOP	L Series	S, T Series	mC-Print3 (1st Gen.)	mC-Print2	TSP100IV TSP100IV SK	mC-Label3	mC-Print3 (2nd Gen.)	BSC10II		
7	Fixed at "0"	-	-	-	-	-	-	-	-	-	-	-	-	
6	Replacement notification	No notification	Notification exists	-	-	-	-	-	-	-	OK	-	-	
5	Cleaning notification	No notification	Notification exists	-	-	-	-	-	-	-	OK	-	-	
4	Fixed at "0"	-	-	-	-	-	-	-	-	-	-	-	-	
3	Paper width	-	-	-	-	-	-	-	-	-	OK	-	-	
2	Paper width	-	-	-	-	-	-	-	-	-	OK	-	-	
1	Paper width	-	-	-	-	-	-	-	-	-	OK	-	-	
0	Fixed at "0"	-	-	-	-	-	-	-	-	-	-	-	-	

## &lt;Paper Width&gt;

mC-Label3:

Bit3	Bit2	Bit2	Paper Width
0	0	0	80.0mm
0	0	1	58.0mm
0	1	0	40.0mm
0	1	1	25.0mm

## 4. Notes

While the automatic status is valid, do not use ESC ACK SOH. Before using these inquiry commands, first be sure to set the automatic status function invalid by DIPSW (memory switch) or ESC RS a n command.

## 5. Status Identification Method

Command/Function	Status							
	bit7	bit6	bit5	bit4	bit3	bit2	bit1	bit0
XON	0	0	0	1	0	0	0	1
XOFF	0	0	0	1	0	0	1	1
ASB (header 1)	0	*	*	0	*	*	*	1
ASB (Other than header 1)	0	*	*	0	*	*	*	0

0 = Indicates a bit fixed to "0". / 1 = Indicates a bit fixed to "1". / \* = Indicates a variable bit.



#### 4.2.2. Printer Status Transmission Specification for Ethernet I/F

Describes the printer status transmission specification for the Ethernet I/F

##### 1) Transmission format

- If you want to send only STAR ASB  
 $\boxed{\text{STAR ASB (2nd byte Bit-7=1)}} + \boxed{\text{Length}}$  ( Length = 0x0000 )
- If you want to send printer status transmission other than STAR ASB  
 $\boxed{\text{STAR ASB (2nd byte Bit-7=1)}} + \boxed{\text{Length}} + \boxed{\text{Status Data}}$

<Length details>

- 2-byte value indicating the number of bytes of status data ( $0x0000 \leq \text{Length} \leq 0x0200$ )
- If Status data is 10 bytes, Length = 0x000a
- If sending only STAR ASB, add Length = 0x0000
- If length is added to STAR ASB second byte Bit-7, then is set to Bit-7 = 1

Detect whether analysis of status detects all the bytes for ASB for the first byte STAR ASB, and length is added to the bit-7 for the 2nd byte for STAR ASB.

Furthermore by obtaining the number of bytes of subsequent Status Data with the length, analyzed status is possible.

##### 2) $\boxed{\text{Status Data}}$ Transmission format

$\boxed{\text{Status Type}} + \boxed{\text{delimiter 1}} + \boxed{\text{Data Type}} + \boxed{\text{Status Length}} + \boxed{\text{Printer Status}} + \boxed{\text{delimiter 2}}$

1. Status Type (2byte or 4Byte)
  - < Header 1 (the second byte) >  
 It indicates the cause of printer status
2. Delimiter 1 (1 byte)  
 Transmit “:”
3. Data Type (1 byte)  
 Indicate the data type of the Printer Status, and send "B" (the binary type)
4. Status Length (2byte)  
 2-byte value that indicates the number of bytes in the Printer Status
5. Printer Status (variable length)  
 Status transmitted by the printer  
 Status contents are different due to the occurrence factor  
 For more information on status content, refer to cause of command, and automatic status
6. Delimiter 2 (1 byte)  
 Transmit “,”

## 3) Status transmission specification list

Status causes	STAR ASB	Length	Status Data					
			Status Type	Delimiter 1	Data Type	Status Length	Printer Status	Delimiter 2
			The first and second byte occurrence factor					
ASB Automatic status (*1)	ASB	0x0000	--	--	--	--	--	--
ESC ACK SOH Request printer status	ASB	0x0000	--	--	--	--	--	--
ESC # * Request printer version	ASB	Variable length	"11"	“.”	“B”	Variable length	Status	“.” ,”
ESC GS ETX s n1 n2 Request print end counter	ASB	0x000F	"20"	“.”	“B”	0x0008	Status	“.” ,”
Request other command response	ASB	Variable length	"A1"	“.”	“B”	Variable length	Block Data	“.” ,”

\*1) For automatic status it is delivered to all hosts in the TCP # 9100 port connection.

Note) Depending on a model, the installed memory switch region differs.

### 4.3. Appendix 3: Blank Code Page Configuration

Blank code pages are character code tables that are empty from character code 80H to FFH. They can be specified using the command below.

- ESC GS t n (n=255)

Also, it is possible to write data to the blank code page area using the command below.

- ESC GS = ... ..

#### 1. Example configuration of Font A data. (12 x 24 font)

	MSB				LSB					MSB				LSB			
d1									d2					0	0	0	0
d3							.	.	d4					0	0	0	0
d5			.	.	.	.	.	.	d6	.	.			0	0	0	0
d7			.	.					d8	.	.			0	0	0	0
d9		.	.						d10		.	.		0	0	0	0
d11		.	.						d12		.	.		0	0	0	0
d13		.	.						d14		.	.		0	0	0	0
d15									d16		.	.		0	0	0	0
d17									d18	.	.			0	0	0	0
d19									d20	.	.			0	0	0	0
d21								.	d22	.				0	0	0	0
d23								.	d24					0	0	0	0
d25								.	d26					0	0	0	0
d27							.	.	d28					0	0	0	0
d29							.	.	d30					0	0	0	0
d31							.	.	d32					0	0	0	0
d33							.	.	d34					0	0	0	0
d35			.	.					d36					0	0	0	0
d37		.	.	.					d38					0	0	0	0
d39		.	.	.	.	.	.	.	d40	.	.	.		0	0	0	0
d41		.	.	.	.	.	.	.	d42	.	.	.		0	0	0	0
d43									d44					0	0	0	0
d45									d46					0	0	0	0
d47									d48					0	0	0	0

Fig. A-1 12 x 24 Font

## 2. Example configuration of Font B data. (9 x 24 font)

The STAR mode is not loaded with Font B. However, when registering data, Font A and Font B must be registered as a set. When doing so, Font B data can be zero data.

	MSB				LSB					MSB				LSB			
d1									d2	0	0	0	0	0	0	0	
d3				.	.	.	.		d4	0	0	0	0	0	0	0	
d5			.	.	.	.	.		d6	0	0	0	0	0	0	0	
d7			.	.		.	.	.	d8	0	0	0	0	0	0	0	
d9	.	.					.	.	d10	0	0	0	0	0	0	0	
d11	.	.					.	.	d12	0	0	0	0	0	0	0	
d13	.	.					.	.	d14	0	0	0	0	0	0	0	
d15							.	.	d16	0	0	0	0	0	0	0	
d17							.	.	d18	0	0	0	0	0	0	0	
d19							.	.	d20	0	0	0	0	0	0	0	
d21							.	.	d22	0	0	0	0	0	0	0	
d23					.	.	.	.	d24	0	0	0	0	0	0	0	
d25					.	.	.		d26	0	0	0	0	0	0	0	
d27				.	.	.			d28	0	0	0	0	0	0	0	
d29			.	.	.				d30	0	0	0	0	0	0	0	
d31			.	.					d32	0	0	0	0	0	0	0	
d33			.	.					d34	0	0	0	0	0	0	0	
d35	.	.	.						d36	0	0	0	0	0	0	0	
d37	.	.	.						d38	0	0	0	0	0	0	0	
d39	.	.	.	.	.	.	.	.	d40	0	0	0	0	0	0	0	
d41	.	.	.	.	.	.	.	.	d42	0	0	0	0	0	0	0	
d43									d44	0	0	0	0	0	0	0	
d45									d46	0	0	0	0	0	0	0	
d47									d48	0	0	0	0	0	0	0	

Fig. A-2 9 x 24 Font

## 3. Example configuration of Font C data. (9 x 17 font)

	MSB				LSB					MSB				LSB			
d1			.	.	.				d2	0	0	0	0	0	0	0	
d3			.	.	.	.	.		d4	0	0	0	0	0	0	0	
d5			.	.		.	.	.	d6	0	0	0	0	0	0	0	
d7	.	.				.	.	.	d8	0	0	0	0	0	0	0	
d9	.	.				.	.	.	d10	0	0	0	0	0	0	0	
d11	.	.				.	.	.	d12	0	0	0	0	0	0	0	
d13						.	.	.	d14	0	0	0	0	0	0	0	
d15						.	.	.	d16	0	0	0	0	0	0	0	
d17						.	.	.	d18	0	0	0	0	0	0	0	
d19					.	.	.	.	d20	0	0	0	0	0	0	0	
d21			.	.	.	.	.		d22	0	0	0	0	0	0	0	
d23			.	.	.	.			d24	0	0	0	0	0	0	0	
d25			.	.	.				d26	0	0	0	0	0	0	0	
d27			.	.					d28	0	0	0	0	0	0	0	
d29	.	.	.						d30	0	0	0	0	0	0	0	
d31	.	.	.	.	.	.	.	.	d32	0	0	0	0	0	0	0	
d33	.	.	.	.	.	.	.	.	d34	0	0	0	0	0	0	0	

Fig. A-3 9 x 17 Font

#### 4.4. Appendix 4: Maximum Number of Input Characters for Each Version of QR Code

##### 1) Model 1 Version and Maximum Number of Input Characters

Version	Cell Count on One Side	Mistake Correction Level	Number of Characters	English Characters	Binary	Kanji
1	21	L	40	24	17	10
		M	33	20	14	8
		Q	25	15	11	6
		H	16	10	7	4
2	25	L	81	49	34	20
		M	66	40	28	17
		Q	52	31	22	13
		H	33	20	14	8
3	29	L	131	79	55	33
		M	100	60	42	25
		Q	81	49	34	20
		H	52	31	22	13
4	33	L	186	113	78	48
		M	138	84	58	35
		Q	114	69	48	29
		H	76	46	32	19
5	37	L	253	154	106	65
		M	191	116	80	49
		Q	157	95	66	40
		H	105	63	44	27
6	41	L	321	194	134	82
		M	249	151	104	64
		Q	201	122	84	51
		H	133	81	56	34
7	45	L	402	244	168	103
		M	311	188	130	80
		Q	253	154	106	65
		H	167	101	70	43
8	49	L	493	299	206	126
		M	378	229	158	97
		Q	301	183	126	77
		H	203	123	85	52
9	53	L	585	354	244	150
		M	441	267	184	113
		Q	369	223	154	94
		H	239	145	100	61
10	57	L	690	418	287	177
		M	526	319	219	135
		Q	433	262	180	111
		H	291	176	121	74
11	61	L	800	485	333	205
		M	608	368	253	156
		Q	493	299	205	126
		H	342	207	142	87
12	65	L	915	555	381	234
		M	694	421	289	178
		Q	579	351	241	148
		H	390	236	162	100
13	69	L	1030	624	429	264
		M	790	479	329	202
		Q	656	398	273	168
		H	454	275	189	116
14	73	L	1167	707	486	299
		M	877	531	365	225
		Q	738	447	307	189
		H	498	302	207	127

## 2) Model 2 Version and Maximum Number of Input Characters

Version	Cell Count on One Side	Mistake Correction Level	Number of Characters	English Characters	Binary	Kanji
1	21	L	41	25	17	10
		M	34	20	14	8
		Q	27	16	11	7
		H	17	10	7	4
2	25	L	77	47	32	20
		M	63	38	26	16
		Q	48	29	20	12
		H	34	20	14	8
3	29	L	127	77	53	32
		M	101	61	42	26
		Q	77	47	32	20
		H	58	35	24	15
4	33	L	187	114	78	48
		M	149	90	62	38
		Q	111	67	46	28
		H	82	50	34	21
5	37	L	255	154	106	65
		M	202	122	84	52
		Q	144	87	60	37
		H	106	64	44	27
6	41	L	322	195	134	82
		M	255	154	106	65
		Q	178	108	74	45
		H	139	84	58	36
7	45	L	370	224	154	95
		M	293	178	122	75
		Q	207	125	86	53
		H	154	93	64	39
8	49	L	461	279	192	118
		M	365	221	152	93
		Q	259	157	108	66
		H	202	122	84	52
9	53	L	552	335	230	141
		M	432	262	180	111
		Q	312	189	130	80
		H	235	143	98	60
10	57	L	652	395	271	167
		M	513	311	213	131
		Q	364	221	151	93
		H	288	174	119	74
11	61	L	772	468	321	198
		M	604	366	251	155
		Q	427	259	177	109
		H	331	200	137	85
12	65	L	883	535	367	226
		M	691	419	287	177
		Q	489	296	203	125
		H	374	227	155	96
13	69	L	1022	619	425	262
		M	796	483	331	204
		Q	580	352	241	149
		H	427	259	177	109
14	73	L	1101	667	458	282
		M	871	528	362	223
		Q	621	376	258	159
		H	468	283	194	120
15	77	L	1250	758	520	320
		M	991	600	412	254
		Q	703	426	292	180
		H	530	321	220	136

Version	Cell Count on One Side	Mistake Correction Level	Number of Characters	English Characters	Binary	Kanji
16	81	L	1408	854	586	361
		M	1082	656	450	277
		Q	775	470	322	198
		H	602	365	250	154
17	85	L	1548	938	644	397
		M	1212	734	504	310
		Q	876	531	364	224
		H	674	408	280	173
18	89	L	1725	1046	718	442
		M	1346	816	560	345
		Q	948	574	394	243
		H	746	452	310	191
19	93	L	1903	1153	792	488
		M	1500	909	624	384
		Q	1063	644	442	272
		H	813	493	338	208
20	97	L	2061	1249	858	528
		M	1600	970	666	410
		Q	1159	702	482	297
		H	919	557	382	235
21	101	L	2232	1352	929	572
		M	1708	1035	711	438
		Q	1224	742	509	314
		H	969	587	403	248
22	105	L	2409	1460	1003	618
		M	1872	1134	779	480
		Q	1358	823	565	348
		H	1056	640	439	270
23	109	L	2620	1588	1091	672
		M	2059	1248	857	528
		Q	1468	890	611	376
		H	1108	672	461	284
24	113	L	2812	1704	1171	721
		M	2188	1326	911	561
		Q	1588	963	661	407
		H	1228	744	511	315
25	117	L	3057	1853	1273	784
		M	2395	1451	997	614
		Q	1718	1041	715	440
		H	1286	779	535	330
26	121	L	3283	1990	1367	842
		M	2544	1542	1059	652
		Q	1804	1094	751	462
		H	1425	864	593	365
27	125	L	3514	2132	1465	902
		M	2701	1637	1125	692
		Q	1933	1172	805	496
		H	1501	910	625	385
28	129	L	3669	2223	1528	940
		M	2857	1732	1190	732
		Q	2085	1263	868	534
		H	1581	958	658	405
29	133	L	3909	2369	1628	1002
		M	3035	1839	1264	778
		Q	2181	1322	908	559
		H	1677	1016	698	430
30	137	L	4158	2520	1732	1066
		M	3289	1994	1370	843
		Q	2358	1429	982	604
		H	1782	1080	742	457

Version	Cell Count on One Side	Mistake Correction Level	Number of Characters	English Characters	Binary	Kanji
31	141	L	4417	2677	1840	1132
		M	3486	2113	1452	894
		Q	2473	1499	1030	634
		H	1897	1150	790	486
32	145	L	4686	2840	1952	1201
		M	3693	2238	1538	947
		Q	2670	1618	1112	684
		H	2022	1226	842	518
33	149	L	4965	3009	2068	1273
		M	3909	2369	1628	1002
		Q	2805	1700	1168	719
		H	2157	1307	898	553
34	153	L	5253	3183	2188	1347
		M	4134	2506	1722	1060
		Q	2949	1787	1228	756
		H	2301	1394	958	590
35	157	L	5529	3351	2303	1417
		M	4343	2632	1809	1113
		Q	3081	1867	1283	790
		H	2361	1431	983	605
36	161	L	5836	3537	2431	1496
		M	4588	2780	1911	1176
		Q	3244	1966	1351	832
		H	2524	1530	1051	647
37	165	L	6153	3729	2563	1577
		M	4775	2894	1989	1224
		Q	3417	2071	1423	876
		H	2625	1591	1093	673
38	169	L	6479	3927	2699	1661
		M	5039	3054	2099	1292
		Q	3599	2181	1499	923
		H	2735	1658	1139	701
39	173	L	6743	4087	2809	1729
		M	5313	3220	2213	1362
		Q	3791	2298	1579	972
		H	2927	1774	1219	750
40	177	L	7089	4296	2953	1817
		M	5596	3391	2331	1435
		Q	3993	2420	1663	1024
		H	3057	1852	1273	784



## 4.5. Appendix 5: Explanation of Page Mode

### 4.5.1. Overview

This printer is equipped with two print modes. They are standard and page mode.

In standard mode, the printer prints and feeds paper each time it receives the print and paper feed instructions, but the print and paper feed instructions received in page mode are executed on the print region on the specified memory and the printer does not operate. Then, when the ESC GS P6 or ESC GS P7 commands are executed, the printer batch expands data to the printing region and prints. In other words, when printing and performing a line feed for data of "ABCDEF" <LF>, in standard mode, "ABCDEF" is printed and paper is fed one line. In page mode, however, "ABCDEF" is written to the print region specified on the memory, and one line is moved on the memory to write the next print data. This printer will enter page mode using ESC GS P 0. Commands received thereafter are all processed as page mode. By running ESC GS P 6, you can lump-print received data. Also, by running ESC GS P 7, you can return to standard mode after lump printing received data. You can return to standard mode without printing page mode print data using ESC GS P 1. However, print data will be cleared.

<Transitioning to Standard Mode and Page Mode>

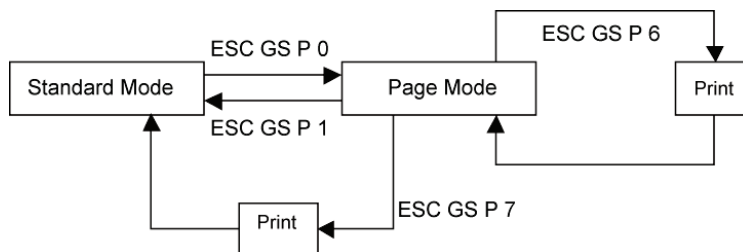

### 4.5.2. Setting Values Using Each Command in Standard Mode and Page Mode

- The values set by each command are shared by both standard and page modes. However, only the settings of the following commands are independently set.  
-> ESC 0, ESC SP, ESC z, ESC D, ESC s, ESC t
- The following commands are invalid in page mode.  
-> ESC GS c, ESC RS m, ESC RS A, ESC GS M, ESC GS r, ESC RS C, ESC \*, ESC RS r, FF, ESC GS S
- The maximum number of dots is prescribed in standard mode, but the y directions (the x direction when there is no rotation) when printing is rotated 90 or 270° are larger than that. For details, see the setting (ESC GS P 3) command of the print region in page mode.

### 4.5.3. Print Data Expansion to the Print Region

Expanding print data to the print region is performed in the following way.

- (1) The print region is set by ESC GS P 3, but when all printing and paper feeds are ended before the printer receives ESC GS P 3 the left edge when facing the printer becomes the origin of the print region (x0, y0). The print region is a square shape using dx pitch for the x direction (horizontal direction) and dy pitch for the y direction (perpendicular direction) as sides, including the origin point from the origin points (x0, y0). (When ESC GS P 3 is not set, the initial value is the print region.)
- (2) When the print region is set by ESC GS P 3, and the printer receives print data after the print direction is set by ESC GS P 2, point A in Fig. 4.6.3.1 becomes the starting point initial value, and the print data is expanded in the print region. For characters, this starting point is the base line. The barcode is also expanded so that the bottom left point of the image data matches the baseline (point B in Fig. 4.6.3.2). However, HRI characters at the bottom of the barcode are printed below the baseline. When a character that is higher than the standard character height (expanded high characters) is expanded at the starting point, the portion above the standard character height will not be printed.
- (3) If the print data is out of the print region (including character right spaces) before receiving commands that accompany line feeds (LF, ESC J and the like), the line feed is automatically performed in the print region, and the expansion position of the print data is moved one line so the next expansion position is at the top of the line. The line feed amount at that time uses the line feed amount set by ESC 0.

< Fig. 4.6.3.1 Expansion Position of Character Data >

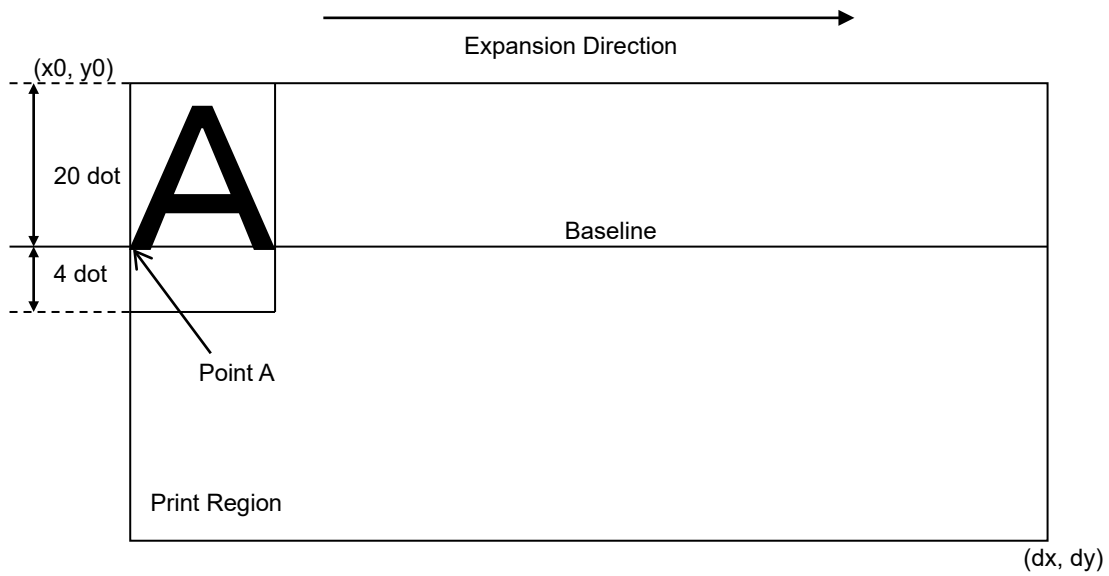

< Fig. 4.6.3.2 Expansion Position of Print Data >

For SM-S and T series, the base line is the upper end of each data.

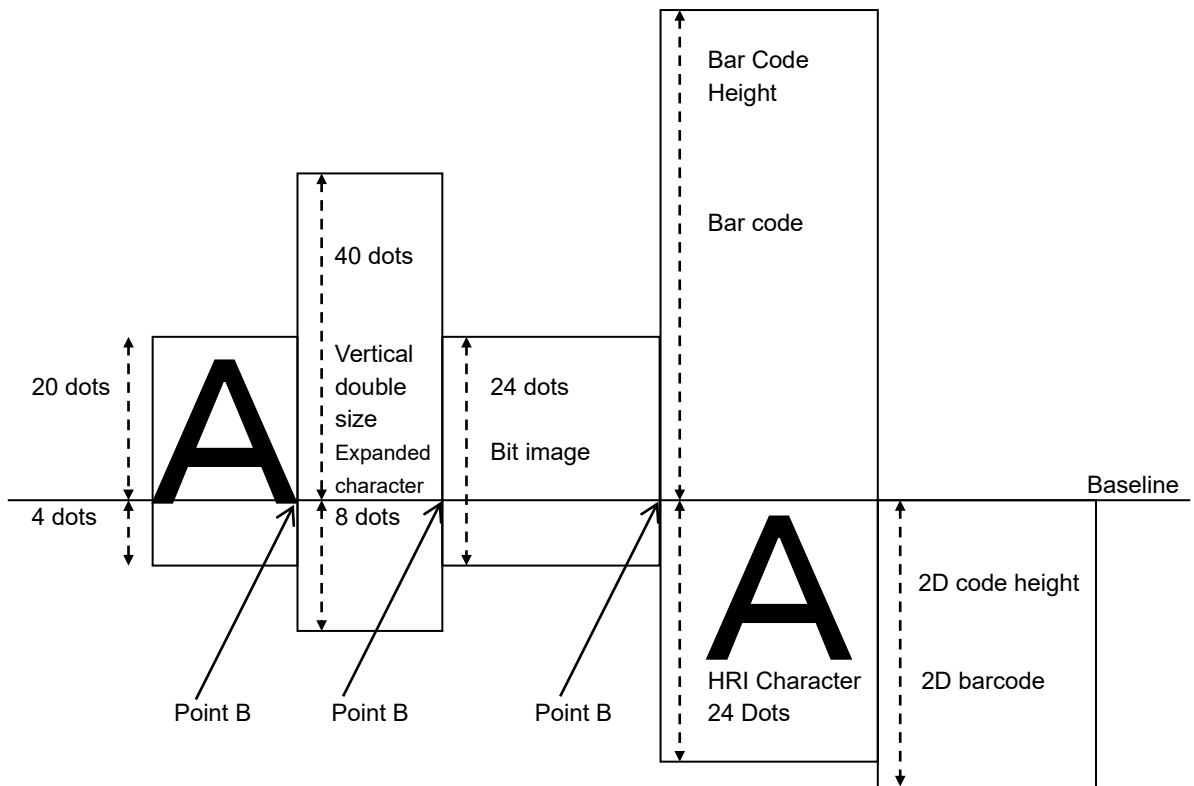

#### 4.5.4. Page Mode Print Maximum Region

Page mode print region initial value, Maximum Value.(ESC GS P 3 xL xH yL yH dxL dxH dyL dyH)

Model	Print region	Initial Value						Maximum Value		Remarks
		dxL	dxH	dyL	dyH	Print region		Print region		
						X Dir.	Y Dir.	X Dir.	Y Dir.	
mPOP mC-Print2	48mm	128	1	170	3	48mm	117.3mm	48mm	300mm	
	54mm	176	1	170	3	54mm	117.3mm	54mm	300mm	
	50.8mm	150	1	170	3	50.8mm	117.3mm	50.8mm	300mm	
SM-L200	48mm	128	1	96	9	48mm	117.3mm	48mm	300mm	
SM-L300	72mm	64	2	96	9	72mm	117.3mm	72mm	300mm	
SM-S210 SM-S220 SM-S230	48mm	128	1	96	9	48mm	117.3mm	48mm	300mm	
SM-T300	72mm	64	2	96	9	72mm	117.3mm	72mm	300mm	
SM-T400	104mm	64	3	96	9	104mm	117.3mm	104mm	300mm	
mC-Print3	72mm	64	2	170	3	72mm	117.3mm	72mm	300mm	
	48mm	128	1	170	3	48mm	117.3mm	48mm	300mm	
	50.8mm	150	1	170	3	50.8mm	117.3mm	50.8mm	300mm	
TSP100IV BSC10II	72mm	64	2	170	3	72mm	117.3mm	72mm	300mm	
	51mm	152	1	170	3	51 mm	117.3mm	51mm	300mm	
	48mm	128	1	170	3	48mm	117.3mm	48mm	300mm	
	50.8mm	150	1	170	3	50.8mm	117.3mm	50.8mm	300mm	
TSP100IV SK	72mm	64	2	170	3	72mm	117.3mm	72mm	300mm	
	51mm	152	1	170	3	51mm	117.3mm	51mm	300mm	
	48mm	128	1	170	3	48mm	117.3mm	48mm	300mm	
	50.8mm	150	1	170	3	50.8mm	117.3mm	50.8mm	300mm	
	52mm	160	1	170	3	52mm	117.3mm	52mm	300mm	
	34.5mm	20	1	170	3	34.5mm	117.3mm	34.5mm	300mm	
	32mm	0	1	170	3	32mm	117.3mm	32mm	300mm	
mC-Label3	72mm	64	2	170	3	72mm	117.3mm	72mm	300mm	The printing area can be set in 1 mm increments in the range of 15 to 72 mm. Only representative values are listed.
	54mm	176	1	170	3	54mm	117.3mm	54mm	300mm	
	48mm	128	1	170	3	48mm	117.3mm	48mm	300mm	
	50.8mm	150	1	170	3	50.8mm	117.3mm	50.8mm	300mm	
	34.5mm	20	1	170	3	34.5mm	117.3mm	34.5mm	300mm	
	52.5mm	164	1	170	3	52.5mm	117.3mm	52.5mm	300mm	

Basic calculated pitch initial value: X=1/203(inch),Y=1/203(inch)

#### 4.6. Appendix 6: Explanation of Print Startup Control Starting Printing When Set to Page Units

When print startup control is set to page units, printing starts when the image buffer length is full or the following commands are run.

If data with vertical movement such as line feed is received, printing starts after a 1-second timeout.

For details on image buffer length and how to set print startup control, see the product specifications manual.

Print starting trigger

- Cutter command : <ESC> d n
- FF command : <FF>
- BM detection command : <ESC> d n, <FF>

## 4.7. Appendix 7: Specifications of Magnetic Cards

### 4.7.1. Card Specifications

The following tables show the summary of data formats stored on the magnetic stripes.

	ISO-1 Track (IATA)
Recording Density	210 BPI
Recording Capacity	79 characters
Data Format	Alphanumeric
Data Capacity	76 characters

	ISO-2 Track (ABA)
Recording Density	75 BPI
Recording Capacity	40 characters
Data Format	Numeric
Data Capacity	37 characters

	ISO-3 Track (MINTS)
Recording Density	210 BPI
Recording Capacity	107 characters
Data Format	Numeric
Data Capacity	104 characters

	JIS-II (JIS)
Recording Density	210 BPI
Recording Capacity	72 characters
Data Format	Alphanumeric
Data Capacity	69 characters

#### 4.7.2. Magnetic Card Data Transmission Format

< 1 / 2 Track Version >

- Track 1

02h 43h 31h 31h 1Ch	DATA (76)	1Ch 03h 0Dh 0Ah
---------------------	-----------	-----------------

- Track 2

02h 44h 31h 31h 1Ch	DATA (37)	03h 0Dh 0Ah
---------------------	-----------	-------------

- Track 1, 2

02h 45h 31h 31h 1Ch 1Ch	DATA (76)	1Ch	DATA (37)	1Ch 03h 0Dh 0Ah
-------------------------	-----------	-----	-----------	-----------------

< 2 / 3 Track Version >

- Track 2

02h 43h 31h 31h 1Ch	DATA (37)	1Ch 03h 0Dh 0Ah
---------------------	-----------	-----------------

- Track 3

02h 44h 31h 31h 1Ch	DATA (104)	03h 0Dh 0Ah
---------------------	------------	-------------

- Track 2, 3

02h 45h 31h 31h 1Ch 1Ch	DATA (37)	1Ch	DATA (104)	1Ch 03h 0Dh 0Ah
-------------------------	-----------	-----	------------	-----------------

< 1 / 2 / 3 Track Version >

- Track 1

02h 43h 31h 31h 1Ch	DATA (76)	1Ch 03h 0Dh 0Ah
---------------------	-----------	-----------------

- Track 2

02h 44h 31h 31h 1Ch	DATA (37)	03h 0Dh 0Ah
---------------------	-----------	-------------

- Track 1, 2

02h 45h 31h 31h 1Ch 1Ch	DATA (76)	1Ch	DATA (37)	1Ch 03h 0Dh 0Ah
-------------------------	-----------	-----	-----------	-----------------

- Track 1, 2, 3

02h 46h 31h 31h 1Ch 1Ch	DATA (76)	1Ch	DATA (37)	1Ch	DATA (104)	1Ch 03h 0Dh 0Ah
-------------------------	-----------	-----	-----------	-----	------------	-----------------

- Track 3

02h 47h 31h 31h 1Ch 1Ch	DATA (104)	03h 0Dh 0Ah
-------------------------	------------	-------------

< JIS-II(JIS) >

F2h 4Ah 31h 31h 1Ch	DATA (69)	1Ch F3h 0Dh 0Ah
---------------------	-----------	-----------------

#### 4.8. Appendix 8: Specifications when a melody speaker is connected

The specifications for each command when a melody speaker is connected are indicated in the table below.

Command	Model Name							
	mPOP	SM-L200	SM-L300	SM-S, T Series	mC-Print3	mC-Print2	mC-Label3	TSP100IV TSP100IV SK
BEL	-	-	-	-	*1 Ver1.3 or later	-	-	*1
FS	-	-	-	-	*1 Ver1.3 or later	-	-	*1
SUB	-	-	-	-	*2 Ver1.3 or later	-	-	*1
EM	-	-	-	-	*2 Ver1.3 or later	-	-	*1
ESC GS EM DC2	-	-	-	-	*1 Ver1.3 or later	-	-	*1

- : Not supported

\*1) After a command is executed, the system waits until melody speaker playback is completed.

\*2) Command is ignored when a melody speaker is connected.

#### 4.9. Appendix 9: Print Area Setting

The print area that is selected by the print area select command ESC RS A n with each product is as shown below.

n	Model Name							
	mPOP	mC-Print2	mC-Print3	TSP100IV BSC10II	TSP100IV SK			
0, "0"	48mm	48mm	72mm	72mm	72mm			
1, "1"	54mm	54mm	(Reserved)	51mm	51mm			
2, "2"	(Reserved)	(Reserved)	48mm	48mm	48mm			
3, "3"	50.8mm	50.8mm	50.8mm	50.8mm	50.8mm			
4, "4"	(Reserved)	(Reserved)	(Reserved)	(Reserved)	(Reserved)			
5, "5"	(Reserved)	(Reserved)	(Reserved)	(Reserved)	34.5mm			
6, "6"	(Reserved)	(Reserved)	(Reserved)	(Reserved)	32mm			
7, "7"	(Reserved)	(Reserved)	(Reserved)	(Reserved)	(Reserved)			

n	Model Name							
	SM-L300	mC-Label3						
0, "0"	72mm	72mm						
1, "1"	(Reserved)	54mm						
2, "2"	(Reserved)	48mm						
3, "3"	50.8mm	50.8mm						
4, "4"	(Reserved)	(Reserved)						
5, "5"	(Reserved)	(Reserved)						
6, "6"	(Reserved)	34.5mm						
7, "7"	(Reserved)	52.5mm						
8	(Reserved)	(Reserved)						
:	:	:						
14	(Reserved)	(Reserved)						
15	(Reserved)	15mm						
16	(Reserved)	16mm						
:	:	:						
29	(Reserved)	29mm						
30	30mm	30mm						
31	31mm	31mm						
32	32mm	32mm						
:	:	:						
70	70mm	70mm						
71	71mm	71mm						
72	72mm	72mm						
73	(Reserved)	(Reserved)						
:	:	:						
127	(Reserved)	(Reserved)						

With SM-L200 and the SM-S, T Series, the print area is fixed and ESC RS A n is disabled.



## 5. COMMAND LIST FOR EACH MODEL

OK: Supported

No: Not supported

-: Not supported (the specification isn't satisfied)

●: Supported (\*depends on the model)

StarLine : TSP650II, TSP700II, TSP800II, FVP10, TUP900, TUP500

### ● Font style and character set

Commands	Model Name											StarLine
	mPOP	SM-L200	SM-L300	SM-S,T Series	mC-Print3 (1st Gen.)	mC-Print2	TSP100IV TSP100IV SK	mC-Label3	mC-Print3 (2nd Gen.)	BSC10II		
ESC RS F	Spec. 1	Spec. 2	Spec. 2	Spec. 2	Spec. 1	Spec. 1	Spec. 1	Spec. 1	Spec. 1	Spec. 1		●
ESC GS t	Spec. 1	Spec. 2	Spec. 2	Spec. 3	Spec. 1	Spec. 1	Spec. 1	Spec. 1	Spec. 1	Spec. 1		OK
ESC GS =	Spec. 1	Spec. 2	Spec. 2	Spec. 2	Spec. 1	Spec. 1	Spec. 1	Spec. 1	Spec. 1	Spec. 1		OK
ESC R	Spec. 1	Spec. 1	Spec. 1	Spec. 1	Spec. 1	Spec. 1	Spec. 1	Spec. 1	Spec. 1	Spec. 2		OK
ESC /	OK	OK	OK	OK	OK	OK	OK	OK	OK	OK		OK
ESC SP	OK	OK	OK	OK	OK	OK	OK	OK	OK	OK		OK
ESC &	OK	No	No	No	OK	OK	OK	OK	OK	OK		OK
ESC %	OK	No	No	No	OK	OK	OK	OK	OK	OK		OK
ESC M	-	-	-	-	-	-	-	-	-	-		OK
ESC P	-	-	-	-	-	-	-	-	-	-		OK
ESC :	-	-	-	-	-	-	-	-	-	-		OK
ESC g	-	-	-	-	-	-	-	-	-	-		OK

### ● Chinese characters

Commands	Model Name											StarLine
	mPOP	SM-L200	SM-L300	SM-S,T Series	mC-Print3 (1st Gen.)	mC-Print2	TSP100IV TSP100IV SK	mC-Label3	mC-Print3 (2nd Gen.)	BSC10II		
ESC p	OK	No	No	No	OK	OK	OK	OK	OK	OK		OK
ESC q	OK	No	No	No	OK	OK	OK	OK	OK	OK		OK
ESC \$	OK	OK	OK	OK	OK	OK	OK	OK	OK	OK		OK
ESC s	OK	OK	OK	OK	OK	OK	OK	OK	OK	OK		OK
ESC t	OK	OK	OK	OK	OK	OK	OK	OK	OK	OK		OK
ESC r	OK	No	No	No	OK	OK	OK	OK	OK	OK		OK

## ● Print modes

Commands	Model Name											StarLine
	mPOP	SM-L200	SM-L300	SM-S,T Series	mC-Print3 (1st Gen.)	mC-Print2	TSP100IV TSP100IV SK	mC-Label3	mC-Print3 (2nd Gen.)	BSC10II		
ESC i	OK	OK	OK	OK	OK	OK	OK	OK	OK	OK		OK
ESC W	OK	OK	OK	OK	OK	OK	OK	OK	OK	OK		OK
ESC h	OK	OK	OK	OK	OK	OK	OK	OK	OK	OK		OK
SO	-	-	-	-	-	-	-	-	-	-		OK
DC4	-	-	-	-	-	-	-	-	-	-		OK
ESC SO	-	-	-	-	-	-	-	-	-	-		OK
ESC DC4	-	-	-	-	-	-	-	-	-	-		OK
ESC E	OK	OK	OK	OK	OK	OK	OK	OK	OK	OK		OK
ESC F	OK	OK	OK	OK	OK	OK	OK	OK	OK	OK		OK
ESC -	OK	OK	OK	OK	OK	OK	OK	OK	OK	OK		OK
ESC _	OK	OK	OK	OK	OK	OK	OK	OK	OK	OK		OK
ESC 4	OK	OK	OK	OK	OK	OK	OK	OK	OK	OK		OK
ESC 5	OK	OK	OK	OK	OK	OK	OK	OK	OK	OK		OK
SI	OK	OK	OK	OK	OK	OK	OK	OK	OK	OK		OK
DC2	OK	OK	OK	OK	OK	OK	OK	OK	OK	OK		OK
ESC GS b	-	-	-	-	-	-	-	-	-	-		●

## ● Horizontal direction position

Commands	Model Name											StarLine
	mPOP	SM-L200	SM-L300	SM-S,T Series	mC-Print3 (1st Gen.)	mC-Print2	TSP100IV TSP100IV SK	mC-Label3	mC-Print3 (2nd Gen.)	BSC10II		
ESC I	OK	OK	OK	OK	OK	OK	OK	OK	OK	OK		OK
ESC Q	OK	OK	OK	OK	OK	OK	OK	OK	OK	OK		OK
HT	OK	OK	OK	OK	OK	OK	OK	OK	OK	OK		OK
ESC D	OK	OK	OK	OK	OK	OK	OK	OK	OK	OK		OK
ESC GS A	OK	OK	OK	OK	OK	OK	OK	OK	OK	OK		OK
ESC GS R	OK	OK	OK	OK	OK	OK	OK	OK	OK	OK		OK
ESC GS a	OK	OK	OK	OK	OK	OK	OK	OK	OK	OK		OK

## ● Line spacing

Commands	Model Name											StarLine
	mPOP	SM-L200	SM-L300	SM-S,T Series	mC-Print3 (1st Gen.)	mC-Print2	TSP100IV TSP100IV SK	mC-Label3	mC-Print3 (2nd Gen.)	BSC10II		
LF	OK	OK	OK	OK	OK	OK	OK	OK	OK	OK	OK	OK
CR	-	-	-	-	-	-	-	-	-	-	-	OK
ESC a	OK	OK	OK	OK	OK	OK	OK	OK	OK	OK	OK	OK
ESC z	OK	OK	OK	OK	OK	OK	OK	OK	OK	OK	OK	OK
ESC 0	OK	OK	OK	OK	OK	OK	OK	OK	OK	OK	OK	OK
ESC J	OK	OK	OK	OK	OK	OK	OK	OK	OK	OK	OK	OK
ESC I	OK	OK	OK	OK	OK	OK	OK	OK	OK	OK	OK	OK

## ● Page control commands

Commands	Model Name											StarLine
	mPOP	SM-L200	SM-L300	SM-S,T Series	mC-Print3 (1st Gen.)	mC-Print2	TSP100IV TSP100IV SK	mC-Label3	mC-Print3 (2nd Gen.)	BSC10II		
FF	OK	OK	OK	OK	OK	OK	OK	OK	OK	OK	OK	OK
ESC C	OK	OK	OK	OK	OK	OK	OK	OK	OK	OK	OK	OK
ESC C NUL	OK	OK	OK	OK	OK	OK	OK	OK	OK	OK	OK	OK
VT	-	-	-	-	-	-	-	-	-	-	-	OK
ESC B	-	-	-	-	-	-	-	-	-	-	-	OK

## ● Top margin

Commands	Model Name											StarLine
	mPOP	SM-L200	SM-L300	SM-S,T Series	mC-Print3 (1st Gen.)	mC-Print2	TSP100IV TSP100IV SK	mC-Label3	mC-Print3 (2nd Gen.)	BSC10II		
ESC RS T	No	No	No	No	OK Spec. 1 (MCP31) Spec.2 (MCP30)	No	Spec. 2	Spec. 3	Spec. 1	Spec. 2		No

## ● Page function

Commands	Model Name											StarLine
	mPOP	SM-L200	SM-L300	SM-S,T Series	mC-Print3 (1st Gen.)	mC-Print2	TSP100IV TSP100IV SK	mC-Label3	mC-Print3 (2nd Gen.)	BSC10II		
ESC GS h 0	No	No	No	No	OK	OK	OK	OK	OK	OK		●
ESC GS h 1	-	-	-	-	-	-	-	-	-	-	-	●

## ● Cutter control

Commands	Model Name											StarLine
	mPOP	SM-L200	SM-L300	SM-S,T Series	mC-Print3 (1st Gen.)	mC-Print2	TSP100IV TSP100IV SK	mC-Label3	mC-Print3 (2nd Gen.)	BSC10II		
ESC d	Spec. 1	Spec. 1	Spec. 1	Spec. 1	Spec. 1	Spec. 1	Spec. 1 (TSP100IV) Spec. 2 (TSP100IV SK)	Spec. 1	Spec. 1	Spec. 1		OK

## ● Reduced Printing

Commands	Model Name											StarLine
	mPOP	SM-L200	SM-L300	SM-S,T Series	mC-Print3 (1st Gen.)	mC-Print2	TSP100IV TSP100IV SK	mC-Label3	mC-Print3 (2nd Gen.)	BSC10II		
ESC GS c h v	Spec. 1	No	No	No	Spec. 1	Spec. 1	Spec. 2	Spec. 1	Spec. 1	Spec. 2		●

## ● Page Mode Commands

Commands	Model Name											StarLine
	mPOP	SM-L200	SM-L300	SM-S,T Series	mC-Print3 (1st Gen.)	mC-Print2	TSP100IV TSP100IV SK	mC-Label3	mC-Print3 (2nd Gen.)	BSC10II		
ESC GS P 0	V1.1 or later	V1.1 or later	OK	OK	OK	OK	OK	OK	OK	OK		●
ESC GS P 1	V1.1 or later	V1.1 or later	OK	OK	OK	OK	OK	OK	OK	OK		●
ESC GS P 2	V1.1 or later	V1.1 or later	OK	OK	OK	OK	OK	OK	OK	OK		●
ESC GS P 3	V1.1 or later	V1.1 or later	OK	OK	OK	OK	OK	OK	OK	OK		●
ESC GS P 4	V1.1 or later	V1.1 or later	OK	OK	OK	OK	OK	OK	OK	OK		●
ESC GS P 5	V1.1 or later	V1.1 or later	OK	OK	OK	OK	OK	OK	OK	OK		●
ESC GS P 6	V1.1 or later	V1.1 or later	OK	OK	OK	OK	OK	OK	OK	OK		●
ESC GS P 7	V1.1 or later	V1.1 or later	OK	OK	OK	OK	OK	OK	OK	OK		●
ESC GS P 8	V1.1 or later	V1.1 or later	OK	OK	OK	OK	OK	OK	OK	OK		●

## ● Bit image Graphics

Commands	Model Name											StarLine
	mPOP	SM-L200	SM-L300	SM-S,T Series	mC-Print3 (1st Gen.)	mC-Print2	TSP100IV TSP100IV SK	mC-Label3	mC-Print3 (2nd Gen.)	BSC10II		
ESC K	OK	OK	OK	OK	OK	OK	OK	OK	OK	OK	OK	OK
ESC L	OK	OK	OK	OK	OK	OK	OK	OK	OK	OK	OK	OK
ESC k	OK	OK	OK	OK	OK	OK	OK	OK	OK	OK	OK	OK
ESC X	OK	OK	OK	OK	OK	OK	OK	OK	OK	OK	OK	OK
ESC GS S	OK	OK	OK	OK	OK	OK	OK	OK	OK	OK	OK	●
ESC GS X	No	OK	OK	No	No	No	No	No	No	No	No	-

## ● Logos

Commands	Model Name											StarLine
	mPOP	SM-L200	SM-L300	SM-S,T Series	mC-Print3 (1st Gen.)	mC-Print2	TSP100IV TSP100IV SK	mC-Label3	mC-Print3 (2nd Gen.)	BSC10II		
ESC GS ( L (fn=48)	OK	OK	OK	OK	OK	OK	OK	OK	OK	OK	OK	●
ESC GS ( L (fn=51)	OK	OK	OK	OK	OK	OK	OK	OK	OK	OK	OK	●
ESC GS ( L (fn=64)	OK	OK	OK	OK	OK	OK	OK	OK	OK	OK	OK	●
ESC GS ( L (fn=65)	OK	OK	OK	OK	OK	OK	OK	OK	OK	OK	OK	●
ESC GS ( L (fn=66)	OK	OK	OK	OK	OK	OK	OK	OK	OK	OK	OK	●
ESC GS ( L (fn=67)	OK	OK	OK	OK	OK	OK	OK	OK	OK	OK	OK	●
ESC GS ( L (fn=69)	OK	OK	OK	OK	OK	OK	OK	OK	OK	OK	OK	●
ESC GS 8 L (fn=48)	OK	OK	OK	OK	OK	OK	OK	OK	OK	OK	OK	●
ESC GS 8 L (fn=51)	OK	OK	OK	OK	OK	OK	OK	OK	OK	OK	OK	●
ESC GS 8 L (fn=64)	OK	OK	OK	OK	OK	OK	OK	OK	OK	OK	OK	●
ESC GS 8 L (fn=65)	OK	OK	OK	OK	OK	OK	OK	OK	OK	OK	OK	●
ESC GS 8 L (fn=66)	OK	OK	OK	OK	OK	OK	OK	OK	OK	OK	OK	●
ESC GS 8 L (fn=67)	OK	OK	OK	OK	OK	OK	OK	OK	OK	OK	OK	●
ESC GS 8 L (fn=69)	OK	OK	OK	OK	OK	OK	OK	OK	OK	OK	OK	●
ESC GS ) L (fn = 48)	OK	OK	OK	OK	OK	OK	OK	OK	OK	OK	OK	●
ESC GS ) L (fn = 49)	OK	OK	OK	OK	OK	OK	OK	OK	OK	OK	OK	●
ESC GS ) L (fn = 50)	OK	OK	OK	OK	OK	OK	OK	OK	OK	OK	OK	●
ESC GS ) L (fn = 51)	No	No	No	No	OK	OK	OK	OK	OK	OK	OK	-
ESC FS q	-	-	-	-	-	-	-	-	-	-	-	OK
ESC FS p	-	-	-	-	-	-	-	-	-	-	-	OK
ESC RS L	-	-	-	-	-	-	-	-	-	-	-	●

## ● Bar code

Commands	Model Name											StarLine
	mPOP	SM-L200	SM-L300	SM-S,T Series	mC-Print3 (1st Gen.)	mC-Print2	TSP100IV TSP100IV SK	mC-Label3	mC-Print3 (2nd Gen.)	BSC10II		
ESC b (n1=0,48)	Spec. 1	Spec. 1	Spec. 1	Spec. 1	Spec. 1	Spec. 1	Spec. 1	Spec. 1	Spec. 1	Spec. 1	Spec. 1	●
ESC b (n1=1,48)	Spec. 1	Spec. 1	Spec. 1	Spec. 1	Spec. 1	Spec. 1	Spec. 1	Spec. 1	Spec. 1	Spec. 1	Spec. 1	●
ESC b (n1=2,48)	Spec. 1	Spec. 1	Spec. 1	Spec. 1	Spec. 1	Spec. 1	Spec. 1	Spec. 1	Spec. 1	Spec. 1	Spec. 1	●
ESC b (n1=3,48)	Spec. 1	Spec. 1	Spec. 1	Spec. 1	Spec. 1	Spec. 1	Spec. 1	Spec. 1	Spec. 1	Spec. 1	Spec. 1	●
ESC b (n1=4,48)	Spec. 1	Spec. 1	Spec. 1	Spec. 1	Spec. 1	Spec. 1	Spec. 1	Spec. 1	Spec. 1	Spec. 1	Spec. 1	●
ESC b (n1=5,48)	Spec. 1	Spec. 1	Spec. 1	Spec. 1	Spec. 1	Spec. 1	Spec. 1	Spec. 1	Spec. 1	Spec. 1	Spec. 1	●
ESC b (n1=6,48)	Spec. 1	Spec. 1	Spec. 1	Spec. 1	Spec. 1	Spec. 1	Spec. 1	Spec. 3	Spec. 1	Spec. 1	Spec. 1	●
ESC b (n1=7,48)	Spec. 1	Spec. 1	Spec. 1	Spec. 1	Spec. 1	Spec. 1	Spec. 1	Spec. 1	Spec. 1	Spec. 1	Spec. 1	●
ESC b (n1=8,48)	Spec. 1	Spec. 1	Spec. 1	Spec. 1	Spec. 1	Spec. 1	Spec. 1	Spec. 1	Spec. 1	Spec. 1	Spec. 1	●
ESC b (n1=9,48)	Spec. 1	No	Spec. 1	Spec. 1	Spec. 1	Spec. 1	Spec. 1	Spec. 1	Spec. 1	Spec. 1	Spec. 1	●
ESC b (n1=10,48)	Spec. 1	No	Spec. 1	Spec. 1	Spec. 1	Spec. 1	Spec. 1	Spec. 1	Spec. 1	Spec. 1	Spec. 1	●
ESC b (n1=11,48)	Spec. 1	No	Spec. 1	Spec. 1	Spec. 1	Spec. 1	Spec. 1	Spec. 1	Spec. 1	Spec. 1	Spec. 1	●
ESC b (n1=12,48)	Spec. 1	No	Spec. 1	Spec. 1	Spec. 1	Spec. 1	Spec. 1	Spec. 1	Spec. 1	Spec. 1	Spec. 1	●
ESC b (n1=13,48)	Spec. 1	No	Spec. 1	Spec. 1	Spec. 1	Spec. 1	Spec. 1	Spec. 1	Spec. 1	Spec. 1	Spec. 1	●

\*SM-S230i only : Ver2.0 or later.

## ● 2D code, QR Commands

Commands	Model Name											StarLine
	mPOP	SM-L200	SM-L300	SM-S,T Series	mC-Print3 (1st Gen.)	mC-Print2	TSP100IV TSP100IV SK	mC-Label3	mC-Print3 (2nd Gen.)	BSC10II		
ESC GS y S 0	Spec. 1	Spec. 2	Spec. 2	Spec. 2	Spec. 1	Spec. 1	Spec. 1	Spec. 1	Spec. 1	Spec. 1	Spec. 1	●
ESC GS y S 1	OK	OK	OK	OK	OK	OK	OK	OK	OK	OK	OK	●
ESC GS y S 2	OK	OK	OK	OK	OK	OK	OK	OK	OK	OK	OK	●
ESC GS y D 1	OK	OK	OK	OK	OK	OK	OK	OK	OK	OK	OK	●
ESC GS y D 2	OK	OK	OK	OK	OK	OK	OK	OK	OK	OK	OK	●
ESC GS y P	OK	OK	OK	OK	OK	OK	OK	OK	OK	OK	OK	●

## ● 2D code, PDF417 Commands

Commands	Model Name											StarLine
	mPOP	SM-L200	SM-L300	SM-S,T Series	mC-Print3 (1st Gen.)	mC-Print2	TSP100IV TSP100IV SK	mC-Label3	mC-Print3 (2nd Gen.)	BSC10II		
ESC GS x S 0	OK	V1.1 or later	OK	OK	OK	OK	OK	OK	OK	OK	OK	OK
ESC GS x S 1	OK	V1.1 or later	OK	OK	OK	OK	OK	OK	OK	OK	OK	OK
ESC GS x S 2	OK	V1.1 or later	OK	OK	OK	OK	OK	OK	OK	OK	OK	OK
ESC GS x S 3	OK	V1.1 or later	OK	OK	OK	OK	OK	OK	OK	OK	OK	OK
ESC GS x D	OK	V1.1 or later	OK	OK	OK	OK	OK	OK	OK	OK	OK	OK
ESC GS x P	OK	V1.1 or later	OK	OK	OK	OK	OK	OK	OK	OK	OK	OK

## ● 2D GS1 code, Compound symbol Commands

Commands	Model Name											StarLine
	mPOP	SM-L200	SM-L300	SM-S,T Series	mC-Print3 (1st Gen.)	mC-Print2	TSP100IV TSP100IV SK	mC-Label3	mC-Print3 (2nd Gen.)	BSC10II		
ESC GS (k (cn=51,fn=67)	OK	No	OK	OK *	OK	OK	OK	OK	OK	OK		•
ESC GS (k (cn=51,fn=71)	OK	No	OK	OK *	OK	OK	OK	OK	OK	OK		•
ESC GS (k (cn=51,fn=80)	OK	No	OK	OK *	OK	OK	OK	OK	OK	OK		•
ESC GS (k (cn=51,fn=81)	OK	No	OK	OK *	OK	OK	OK	OK	OK	OK		•
ESC GS (k (cn=52,fn=67)	OK	No	OK	OK *	OK	OK	OK	OK	OK	OK		•
ESC GS (k (cn=52,fn=71)	OK	No	OK	OK *	OK	OK	OK	OK	OK	OK		•
ESC GS (k (cn=52,fn=72)	OK	No	OK	OK *	OK	OK	OK	OK	OK	OK		•
ESC GS (k (cn=52,fn=80)	OK	No	OK	OK *	OK	OK	OK	OK	OK	OK		•
ESC GS (k (cn=52,fn=81)	OK	No	OK	OK *	OK	OK	OK	OK	OK	OK		•

\*SM-S230i only : Ver2.0 or later.

## ● Initialization Command

Commands	Model Name											StarLine
	mPOP	SM-L200	SM-L300	SM-S,T Series	mC-Print3 (1st Gen.)	mC-Print2	TSP100IV TSP100IV SK	mC-Label3	mC-Print3 (2nd Gen.)	BSC10II		
CAN	-	-	-	-	-	-	-	-	-	-		OK
ESC @	OK	OK	OK	OK	OK	OK	OK	OK	OK	OK		OK
ESC ACK CAN	OK	OK	OK	OK	OK	OK	OK	OK	OK	OK		•
ESC ? LF NUL	OK	OK	OK	OK	OK	OK	OK	OK	OK	OK		OK

## ● Memory Switch Command

Commands	Model Name											StarLine
	mPOP	SM-L200	SM-L300	SM-S,T Series	mC-Print3 (1st Gen.)	mC-Print2	TSP100IV TSP100IV SK	mC-Label3	mC-Print3 (2nd Gen.)	BSC10II		
ESC GS # m	OK	OK	OK	OK	OK	OK	OK	No	OK	OK		OK

## ● Status

Commands	Model Name											StarLine
	mPOP	SM-L200	SM-L300	SM-S,T Series	mC-Print3 (1st Gen.)	mC-Print2	TSP100IV TSP100IV SK	mC-Label3	mC-Print3 (2nd Gen.)	BSC10II		
ESC RS a	OK	OK	OK	OK	OK	OK	OK	OK	OK	OK	OK	OK
ESC ACK SOH	OK	OK	OK	OK	OK	OK	OK	OK	OK	OK	OK	OK
ENQ	-	-	-	-	-	-	-	-	-	-	-	OK
EOT	-	-	-	-	-	-	-	-	-	-	-	OK
ETB	OK	OK	OK	OK	OK	OK	OK	OK	OK	OK	OK	OK
ESC RS E	OK	OK	OK	OK	OK	OK	OK	OK	OK	OK	OK	OK
ESC GS ETX	Spec. 2	Spec. 2	Spec. 2	Spec. 2	Spec. 1	Spec. 1	Spec. 1	Spec. 3	Spec. 1	Spec. 1		OK
ESC # *	OK	OK	OK	OK	OK	OK	OK	OK	OK	OK	OK	OK
ESC GS ) I (fn =48)	OK	No	No	No	OK	OK	OK	OK	OK	OK	OK	●
ESC GS ) I (fn =49)	Spec. 1 Ver.2.3 or earlier Spec. 2 Ver.3.0 or later Spec. 8 Ver.4.0 or later Spec. 12 Ver.5.0 or later	No	No	Spec. 6 Ver.4.1 or later *	Spec. 3 Ver.2.4 or earlier Spec. 4 Ver.3.0 Spec. 5 Ver.3.1 or later	Spec. 3 Ver.2.4 or earlier Spec. 4 Ver.3.0 Spec. 5 Ver.3.1 or later	Spec. 7 (TSP100IV V1.2 or earlier) Spec. 10 (TSP100IV V2.0 or later) (TSP100IV SK)	Spec. 9	Spec. 11	Spec. 10		-
ESC GS ) I (fn =50)	No	No	OK	OK	No	No	No	No	No	No	No	-
ESC GS ) I (fn =51)	No	No	No	No	OK	OK	OK	OK	OK	OK	OK	-
ESC GS ) I (fn =52)	No	No	No	No	V1.3 or later	No	OK	OK	OK	OK	OK	-
ESC GS J (fn=48)	No	No	No	No	No	No	No	No	OK	No		-
ESC GS J (fn=49)	No	No	No	No	No	No	No	No	OK	No		-

\*SM-S230 only :Ver.1.5 or later



## ● Print settings

Commands	Model Name											StarLine
	mPOP	SM-L200	SM-L300	SM-S,T Series	mC-Print3 (1st Gen.)	mC-Print2	TSP100IV TSP100IV SK	mC-Label3	mC-Print3 (2nd Gen.)	BSC10II		
ESC RS A	OK	No	OK	No	OK	OK	OK	OK	OK	OK		●
ESC RS d	Spec. 2	Spec. 3	Spec. 3	Spec. 4	Spec. 1 Ver.2.4 or earlier Spec.5 Ver.3.0 or later	Spec. 2	Spec. 1	Spec. 1	Spec. 5	Spec. 1		OK
ESC RS r	Spec. 2	No	No	Spec. 3	Spec. 1	No	Spec. 1	Spec. 1	Spec. 1	Spec. 1		OK

## ● Special Commands

Commands	Model Name											StarLine
	mPOP	SM-L200	SM-L300	SM-S,T Series	mC-Print3 (1st Gen.)	mC-Print2	TSP100IV TSP100IV SK	mC-Label3	mC-Print3 (2nd Gen.)	BSC10II		
ESC RS R	V.1.2 or later	No	No	No	OK	OK	OK	OK	OK	OK		-
ESC GS m	No	No	No	No	No	No	No	OK	No	No		No

## ● UTF Commands

Commands	Model Name											StarLine
	mPOP	SM-L200	SM-L300	SM-S,T Series	mC-Print3 (1st Gen.)	mC-Print2	TSP100IV TSP100IV SK	mC-Label3	mC-Print3 (2nd Gen.)	BSC10II		
ESC GS ) U (fn=48)	OK	No	No	No	OK	OK	OK	OK	OK	OK		●
ESC GS ) U (fn=64)	Spec. 1: Ver.2.0 or older Spec. 2: Ver2.1 or later	No	No	No	Spec. 2	Spec. 2	Spec. 2	Spec. 2	Spec. 2	Spec. 2		●
ESC GS ) U (fn=65)	No	No	No	No	OK	OK	OK	OK	OK	OK		●

## ● Black Mark Commands

Commands	Model Name											StarLine
	mPOP	SM-L200	SM-L300	SM-S,T Series	mC-Print3 (1st Gen.)	mC-Print2	TSP100IV TSP100IV SK	mC-Label3	mC-Print3 (2nd Gen.)	BSC10II		
ESC d	No	OK	OK	OK	No	No	No	OK	No	No		•
FF	No	OK	OK	OK	No	No	No	OK	No	No		•
ESC C	No	OK	OK	OK	No	No	No	OK	No	No		•
ESC C NUL	No	OK	OK	OK	No	No	No	OK	No	No		•
VT	-	-	-	-	-	-	-	-	-	-		•
ESC B	-	-	-	-	-	-	-	-	-	-		•

## ● 2-Color Printing Related Commands

Commands	Model Name											StarLine
	mPOP	SM-L200	SM-L300	SM-S,T Series	mC-Print3 (1st Gen.)	mC-Print2	TSP100IV TSP100IV SK	mC-Label3	mC-Print3 (2nd Gen.)	BSC10II		
ESC RS c	No	No	No	No	No	No	No	No	No	No		•
ESC RS C	No	No	No	No	No	No	No	No	No	No		•
ESC 4	No	No	No	No	No	No	No	No	No	No		•
ESC 5	No	No	No	No	No	No	No	No	No	No		•

## ● External device drive

Commands	Model Name											StarLine
	mPOP	SM-L200	SM-L300	SM-S,T Series	mC-Print3 (1st Gen.)	mC-Print2	TSP100IV TSP100IV SK	mC-Label3	mC-Print3 (2nd Gen.)	BSC10II		
ESC BEL	Ver.2.0 or later	No	No	No	OK	OK	OK	OK	OK	OK		•
BEL	OK	No	No	No	OK	OK	OK	OK	OK	OK		•
FS	OK	No	No	No	OK	OK	OK	OK	OK	OK		•
SUB	Ver.2.0 or later	No	No	No	OK	OK	OK	OK	OK	OK		•
EM	Ver.2.0 or later	No	No	No	OK	OK	OK	OK	OK	OK		•
ESC GS BEL	No	No	No	No	No	No	-	-	-	-		•
ESC GS EM DC1	Ver.2.0 or later	No	No	No	OK	OK	OK	OK	OK	OK		•
ESC GS EM DC2	Ver.2.0 or later	No	No	No	OK	OK	OK	OK	OK	OK		•

**● Melody Speaker Command**

Commands	Model Name											StarLine
	mPOP	SM-L200	SM-L300	SM-S,T Series	mC-Print3 (1st Gen.)	mC-Print2	TSP100IV TSP100IV SK	mC-Label3	mC-Print3 (2nd Gen.)	BSC10II		
ESC GS s R	No	No	No	No	V1.3 or later	No	OK	No	OK	OK		-

**● Barcode reader Command**

Commands	Model Name											StarLine
	mPOP	SM-L200	SM-L300	SM-S,T Series	mC-Print3 (1st Gen.)	mC-Print2	TSP100IV TSP100IV SK	mC-Label3	mC-Print3 (2nd Gen.)	BSC10II		
ESC GS B 0	OK	No	No	No	OK	OK	OK	OK	OK	No		-
ESC GS B 1	OK	No	No	No	OK	OK	OK	OK	OK	No		-
ESC GS B 2	OK	No	No	No	OK	OK	OK	OK	OK	No		-
ESC GS B 3	OK	No	No	No	OK	OK	OK	OK	OK	No		-

**● Magnetic Card Reader Commands**

Commands	Model Name											StarLine
	mPOP	SM-L200	SM-L300	SM-S,T Series	mC-Print3 (1st Gen.)	mC-Print2	TSP100IV TSP100IV SK	mC-Label3	mC-Print3 (2nd Gen.)	BSC10II		
ESC M C	No	V1.1 or later	OK	OK	No	No	No	No	No	No		-
ESC M D	No	V1.1 or later	OK	OK	No	No	No	No	No	No		-
ESC M E	No	V1.1 or later	OK	OK	No	No	No	No	No	No		-
ESC M F	No	V1.1 or later	OK	OK	No	No	No	No	No	No		-
ESC M G	No	V1.1 or later	OK	OK	No	No	No	No	No	No		-
ESC M J	No	V1.1 or later	OK	OK	No	No	No	No	No	No		-
EOT	No	V1.1 or later	OK	OK	No	No	No	No	No	No		-

**● Customer display Commands**

Commands	Model Name											StarLine
	mPOP	SM-L200	SM-L300	SM-S,T Series	mC-Print3 (1st Gen.)	mC-Print2	TSP100IV TSP100IV SK	mC-Label3	mC-Print3 (2nd Gen.)	BSC10II		
ESC GS B @	V2.0 or later	No	No	No	OK	OK	OK	OK	OK	No		-
ESC RS B A	V2.0 or later	No	No	No	OK	OK	OK	OK	OK	No		-
ESC GS B B	V2.0 or later	No	No	No	OK	OK	OK	OK	OK	No		-
ESC GS B C	V2.0 or later	No	No	No	OK	OK	OK	OK	OK	No		-

**• Raster Commands**

Commands	Model Name											StarLine
	mPOP	SM-L200	SM-L300	SM-S,T Series	mC-Print3 (1st Gen.)	mC-Print2	TSP100IV TSP100IV SK	mC-Label3	mC-Print3 (2nd Gen.)	BSC10II		
ESC * r R	-	-	-	-	-	-	-	-	-	-	-	OK
ESC * r A	-	-	-	-	-	-	-	-	-	-	-	OK
ESC * r B	-	-	-	-	-	-	-	-	-	-	-	OK
ESC * r C	-	-	-	-	-	-	-	-	-	-	-	OK
ESC * r D	-	-	-	-	-	-	-	-	-	-	-	OK
ESC * r E	-	-	-	-	-	-	-	-	-	-	-	OK
ESC * r F	-	-	-	-	-	-	-	-	-	-	-	OK
ESC * r P	-	-	-	-	-	-	-	-	-	-	-	OK
ESC * r Q	-	-	-	-	-	-	-	-	-	-	-	OK
ESC * r m l	-	-	-	-	-	-	-	-	-	-	-	OK
ESC * r m r	-	-	-	-	-	-	-	-	-	-	-	OK
ESC * r T	-	-	-	-	-	-	-	-	-	-	-	OK
ESC * r t	-	-	-	-	-	-	-	-	-	-	-	OK
ESC * r K	-	-	-	-	-	-	-	-	-	-	-	OK
b n1 n2 d1. . . dk	-	-	-	-	-	-	-	-	-	-	-	OK
k n1 n2 d1. . . dk	-	-	-	-	-	-	-	-	-	-	-	OK
ESC * r Y	-	-	-	-	-	-	-	-	-	-	-	OK
ESC FF NUL	-	-	-	-	-	-	-	-	-	-	-	OK
ESC FF EOT	-	-	-	-	-	-	-	-	-	-	-	OK
ESC * r N	-	-	-	-	-	-	-	-	-	-	-	•
ESC * r V	-	-	-	-	-	-	-	-	-	-	-	•
ESC * r S	-	-	-	-	-	-	-	-	-	-	-	•
ESC * r s 0	-	-	-	-	-	-	-	-	-	-	-	•
ESC * r s 1	-	-	-	-	-	-	-	-	-	-	-	•
ESC * r s 2	-	-	-	-	-	-	-	-	-	-	-	•
ESC * r s 3	-	-	-	-	-	-	-	-	-	-	-	•

**• Mark Commands**

Commands	Model Name											StarLine
	mPOP	SM-L200	SM-L300	SM-S,T Series	mC-Print3 (1st Gen.)	mC-Print2	TSP100IV TSP100IV SK	mC-Label3	mC-Print3 (2nd Gen.)	BSC10II		
ESC GS * 0	-	-	-	-	-	-	-	-	-	-	-	OK
ESC GS * 1	-	-	-	-	-	-	-	-	-	-	-	OK
ESC GS * 2	-	-	-	-	-	-	-	-	-	-	-	OK
ESC GS * W	-	-	-	-	-	-	-	-	-	-	-	OK
ESC GS * C	-	-	-	-	-	-	-	-	-	-	-	OK

**• Auto Logo Commands**

Commands	Model Name											StarLine
	mPOP	SM-L200	SM-L300	SM-S,T Series	mC-Print3 (1st Gen.)	mC-Print2	TSP100IV TSP100IV SK	mC-Label3	mC-Print3 (2nd Gen.)	BSC10II		
ESC GS / W	-	-	-	-	-	-	-	-	-	-	-	•
ESC GS / C	-	-	-	-	-	-	-	-	-	-	-	•
ESC GS / 1	-	-	-	-	-	-	-	-	-	-	-	•
ESC GS / 2	-	-	-	-	-	-	-	-	-	-	-	•
ESC GS / 3	-	-	-	-	-	-	-	-	-	-	-	•
ESC GS / 4	-	-	-	-	-	-	-	-	-	-	-	•
ESC GS / 5	-	-	-	-	-	-	-	-	-	-	-	•
ESC GS / 6	-	-	-	-	-	-	-	-	-	-	-	•

**• Text Search**

Commands	Model Name											StarLine
	mPOP	SM-L200	SM-L300	SM-S,T Series	mC-Print3 (1st Gen.)	mC-Print2	TSP100IV TSP100IV SK	mC-Label3	mC-Print3 (2nd Gen.)	BSC10II		
ESC GS ) B (fn = 48)	-	-	-	-	-	-	-	-	-	-	-	•
ESC GS ) B (fn = 49)	-	-	-	-	-	-	-	-	-	-	-	•
ESC GS ) B (fn = 50)	-	-	-	-	-	-	-	-	-	-	-	•
ESC GS ) B (fn = 64)	-	-	-	-	-	-	-	-	-	-	-	•
ESC GS ) B (fn = 65)	-	-	-	-	-	-	-	-	-	-	-	•
ESC GS ) B (fn = 66)	-	-	-	-	-	-	-	-	-	-	-	•
ESC GS ) B (fn = 80)	-	-	-	-	-	-	-	-	-	-	-	•
ESC GS ) B (fn = 81)	-	-	-	-	-	-	-	-	-	-	-	•
ESC GS ) B (fn = 96)	-	-	-	-	-	-	-	-	-	-	-	•
ESC GS ) B (fn = 97)	-	-	-	-	-	-	-	-	-	-	-	•

**• Print starting trigger**

Commands	Model Name											StarLine
	mPOP	SM-L200	SM-L300	SM-S,T Series	mC-Print3 (1st Gen.)	mC-Print2	TSP100IV TSP100IV SK	mC-Label3	mC-Print3 (2nd Gen.)	BSC10II		
ESC GS g 0	-	-	-	-	-	-	-	-	-	-	-	•
ESC GS g 1	-	-	-	-	-	-	-	-	-	-	-	•

## ● Presenter Related Commands

Commands	Model Name											StarLine
	mPOP	SM-L200	SM-L300	SM-S,T Series	mC-Print3 (1st Gen.)	mC-Print2	TSP100IV TSP100IV SK	mC-Label3	mC-Print3 (2nd Gen.)	BSC10II		
ESC SYN 0	-	-	-	-	-	-	-	-	-	-	-	●
ESC SYN 1	-	-	-	-	-	-	-	-	-	-	-	●
ESC SYN 3	-	-	-	-	-	-	-	-	-	-	-	●
ESC SYN 4	-	-	-	-	-	-	-	-	-	-	-	●
ESC GS SUB DC1	-	-	-	-	-	-	-	-	-	-	-	●
ESC GS SUB DC2	-	-	-	-	-	-	-	-	-	-	-	●
ESC GS SUB DC3	-	-	-	-	-	-	-	-	-	-	-	●

## ● Audio Commands

Commands	Model Name											StarLine
	mPOP	SM-L200	SM-L300	SM-S,T Series	mC-Print3 (1st Gen.)	mC-Print2	TSP100IV TSP100IV SK	mC-Label3	mC-Print3 (2nd Gen.)	BSC10II		
ESC GS s O	-	-	-	-	-	-	-	-	-	-	-	●
ESC GS s P	-	-	-	-	-	-	-	-	-	-	-	●
ESC GS s R	-	-	-	-	-	-	-	-	-	-	-	●
ESC GS s I	-	-	-	-	-	-	-	-	-	-	-	●
ESC GS s U	-	-	-	-	-	-	-	-	-	-	-	●
ESC GS s T	-	-	-	-	-	-	-	-	-	-	-	●

## ● Network Command

Commands	Model Name											StarLine
	mPOP	SM-L200	SM-L300	SM-S,T Series	mC-Print3 (1st Gen.)	mC-Print2	TSP100IV TSP100IV SK	mC-Label3	mC-Print3 (2nd Gen.)	BSC10II		
ESC GS ) N (fn = 48)	No	No	No	No	OK	OK	OK	OK	OK	OK	OK	-
ESC GS ) N (fn = 49)	No	No	No	No	OK	OK	OK	OK	OK	OK	OK	-
ESC GS ) N (fn = 50)	No	No	No	No	OK	OK	OK	OK	OK	OK	OK	-
ESC GS ) N (fn = 51)	No	No	No	No	OK	OK	OK	OK	OK	OK	OK	-
ESC GS ) N (fn = 52)	No	No	No	No	V1.4 or later	V1.4 or later	OK	OK	OK	OK	OK	-
ESC GS ) N (fn = 53)	No	No	No	No	V1.4 or later	V1.4 or later	OK	OK	OK	OK	OK	-
ESC GS ) N (fn = 54)	No	No	No	No	V1.4 or later	V1.4 or later	OK	OK	OK	OK	OK	-
ESC GS ) N (fn = 55)	No	No	No	No	V1.4 or later	V1.4 or later	OK	No	OK	OK	OK	-
ESC GS ) N (fn = 57)	No	No	No	No	Spec. 1 V2.3 or later	Spec. 1 V2.3 or later	Spec. 1	Spec. 2	Spec. 3	No		-
ESC GS ) N (fn = 58)	No	No	No	No	V3.3 or later	V3.3 or later	OK	OK	OK	No		-
ESC GS ) N (fn = 59)	No	No	No	No	V3.3 or later	V3.3 or later	OK	OK	OK	No		-
ESC GS ) N (fn = 64)	No	No	No	No	OK	OK	OK	OK	OK	OK	OK	-
ESC GS ) N (fn = 65)	No	No	No	No	OK	OK	OK	OK	OK	OK	OK	-
ESC GS ) N (fn = 66)	No	No	No	No	OK	OK	OK	OK	OK	OK	OK	-
ESC GS ) N (fn = 67)	No	No	No	No	OK	OK	OK	OK	OK	OK	OK	-

Commands	Model Name											StarLine
	mPOP	SM-L200	SM-L300	SM-S,T Series	mC-Print3 (1st Gen.)	mC-Print2	TSP100IV TSP100IV SK	mC-Label3	mC-Print3 (2nd Gen.)	BSC10II		
ESC GS ) N (fn=68)	No	No	No	No	V1.4 or later	V1.4 or later	OK	OK	OK	OK		-
ESC GS ) N (fn=69)	No	No	No	No	V1.4 or later	V1.4 or later	OK	OK	OK	OK		-
ESC GS ) N (fn=70)	No	No	No	No	V1.4 or later	V1.4 or later	OK	OK	OK	OK		-
ESC GS ) N (fn=71)	No	No	No	No	V1.4 or later	V1.4 or later	OK	No	OK	OK		-
ESC GS ) N (fn=73)	No	No	No	No	Spec. 1 V2.3 or later	Spec.1 V2.3 or later	Spec. 2	Spec. 2	Spec. 3	No		-
ESC GS ) N (fn=74)	No	No	No	No	V3.3 or later	V3.3 or later	OK	OK	OK	No		-
ESC GS ) N (fn=75)	No	No	No	No	V3.3 or later	V3.3 or later	OK	OK	OK	No		-
ESC GS ) N (fn=80)	No	No	No	No	V3.6 or later	V3.6 or later	Ver1.1 or later	OK	OK	OK		-
ESC GS ) N (fn=81)	No	No	No	No	V3.6 or later	V3.6 or later	Ver1.1 or later	OK	OK	OK		-
ESC GS ) N (fn=82)	No	No	No	No	V3.6 or later	V3.6 or later	Ver1.1 or later	OK	OK	OK		-
ESC GS ) N (fn=83)	No	No	No	No	V3.6 or later	V3.6 or later	Ver1.1 or later	OK	OK	OK		-
ESC GS ) N (fn=84)	No	No	No	No	V3.6 or later	V3.6 or later	Ver1.1 or later	No	OK	OK		-
ESC GS ) N (fn=85)	No	No	No	No	V3.6 or later	V3.6 or later	Ver1.1 or later	No	OK	OK		-
ESC GS ) N (fn=86)	No	No	No	No	V3.6 or later	V3.6 or later	Ver1.1 or later	OK	OK	OK		-
ESC GS ) N (fn=87)	No	No	No	No	V3.6 or later	V3.6 or later	Ver1.1 or later	OK	OK	OK		-
ESC GS ) N (fn=88)	No	No	No	No	V3.6 or later	V3.6 or later	Ver1.1 or later	No	OK	OK		-
ESC GS ) N (fn=89)	No	No	No	No	V3.6 or later	V3.6 or later	Ver1.1 or later	No	OK	OK		-
ESC GS ) N (fn=90)	No	No	No	No	V3.81 or later	V3.81 or later	V2.2 or later	No	Ver5.1 or later	OK		-
ESC GS ) N (fn=91)	No	No	No	No	V3.81 or later	V3.81 or later	V2.2 or later	No	Ver5.1 or later	OK		-
ESC GS ) N (fn=92)	No	No	No	No	V3.81 or later	V3.81 or later	V2.2 or later	No	Ver5.1 or later	OK		-
ESC GS ) N (fn=93)	No	No	No	No	V3.81 or later	V3.81 or later	V2.2 or later	No	Ver5.1 or later	OK		-
ESC GS ) N (fn=94)	No	No	No	No	V3.81 or later	V3.81 or later	V2.2 or later	No	Ver5.1 or later	OK		-
ESC GS ) N (fn=95)	No	No	No	No	V3.81 or later	V3.81 or later	V2.2 or later	No	Ver5.1 or later	OK		-
ESC GS ) N (fn=112)	No	No	No	No	OK	OK	OK	OK	OK	OK		-
ESC GS ) N (fn=113)	No	No	No	No	OK	OK	OK	OK	OK	OK		-
ESC GS ) N (fn=114)	No	No	No	No	V3.0 or later	V3.0 or later	OK	OK	OK	OK		-
ESC GS ) N (fn=115)	No	No	No	No	V3.0 or later	V3.0 or later	OK	OK	OK	OK		-

Commands	Model Name											StarLine
	mPOP	SM-L200	SM-L300	SM-S,T Series	mC-Print3 (1st Gen.)	mC-Print2	TSP100IV TSP100IV SK	mC-Label3	mC-Print3 (2nd Gen.)	BSC10II		
ESC GS ) N (fn = 116)	No	No	No	No	V3.0 or later	V3.0 or later	OK	OK	OK	OK		-
ESC GS ) N (fn = 128)	No	No	No	No	V3.0 or later	V3.0 or later	OK	OK	OK	OK		-
ESC GS ) N (fn = 129)	No	No	No	No	V3.0 or later	V3.0 or later	OK	OK	OK	OK		-
ESC GS ) N (fn = 130)	No	No	No	No	V3.0 or later	V3.0 or later	OK	OK	OK	No		-
ESC GS ) N (fn = 131)	No	No	No	No	V3.0 or later	V3.0 or later	OK	OK	OK	No		-
ESC GS ) N (fn = 132)	No	No	No	No	V3.0 or later	V3.0 or later	OK	OK	OK	No		-
ESC GS ) N (fn = 133)	No	No	No	No	V3.0 or later	V3.0 or later	OK	OK	OK	No		-
ESC GS ) N (fn = 134)	No	No	No	No	V3.0 or later	V3.0 or later	OK	OK	OK	No		-
ESC GS ) N (fn = 135)	No	No	No	No	V3.0 or later	V3.0 or later	OK	OK	OK	No		-
ESC GS ) N (fn = 136)	No	No	No	No	V3.0 or later	V3.0 or later	OK	OK	OK	No		-
ESC GS ) N (fn = 137)	No	No	No	No	V3.0 or later	V3.0 or later	OK	OK	OK	No		-
ESC GS ) N (fn = 138)	No	No	No	No	V3.0 or later	V3.0 or later	OK	OK	OK	No		-
ESC GS ) N (fn = 139)	No	No	No	No	V3.0 or later	V3.0 or later	OK	OK	OK	No		-
ESC GS ) N (fn = 140)	No	No	No	No	Spec. 1 V3.0 to V3.4 Spec. 2 V3.5 or later	Spec. 1 V3.0 to V3.4 Spec. 2 V3.5 or later	Spec. 2	Spec. 2	Spec. 2	No		-
ESC GS ) N (fn = 141)	No	No	No	No	V3.0 or later	V3.0 or later	OK	OK	OK	No		-
ESC GS ) N (fn = 142)	No	No	No	No	V3.0 or later	V3.0 or later	OK	OK	OK	No		-
ESC GS ) N (fn = 143)	No	No	No	No	V3.0 or later	V3.0 or later	OK	OK	OK	No		-
ESC GS ) N (fn = 144)	No	No	No	No	V3.0 or later	V3.0 or later	OK	OK	OK	No		-
ESC GS ) N (fn = 145)	No	No	No	No	V3.0 or later	V3.0 or later	OK	OK	OK	No		-
ESC GS ) N (fn = 146)	No	No	No	No	V3.5 or later	V3.5 or later	OK	OK	OK	No		-
ESC GS ) N (fn = 147)	No	No	No	No	V3.5 or later	V3.5 or later	OK	OK	OK	No		-
ESC GS ) N (fn = 150)	No	No	No	No	V3.5 or later	V3.5 or later	OK	OK	OK	No		-
ESC GS ) N (fn = 152)	No	No	No	No	V3.81 or later	V3.81 or later	V2.2 or later	No	OK	No		-
ESC GS ) N (fn = 153)	No	No	No	No	V3.81 or later	V3.81 or later	V2.2 or later	No	OK	No		-

## ● Command related to paper hold control

Commands	Model Name											StarLine
	mPOP	SM-L200	SM-L300	SM-S,T Series	mC-Print3 (1st Gen.)	mC-Print2	TSP100IV TSP100IV SK	mC-Label3	mC-Print3 (2nd Gen.)	BSC10II		
ESC SYN DC3	No	No	No	No	No	No	No (TSP100IV) OK (TSP100IV SK)	OK	No	No		OK
ESC SYN DC4	No	No	No	No	No	No	No (TSP100IV) OK (TSP100IV SK)	OK	No	No		OK
ESC GS ) s (fn = 48)	No	No	No	No	No	No	V2.0 or later	OK	No	No		OK



## • Spooler

Commands	Model Name											StarLine
	mPOP	SM-L200	SM-L300	SM-S,T Series	mC-Print3 (1st Gen.)	mC-Print2	TSP100IV TSP100IV SK	mC-Label3	mC-Print3 (2nd Gen.)	BSC10II		
ESC GS ) SP (fn = 48)	No	No	No	No	No	No	No	OK	No	No		-
ESC GS ) SP (fn = 49)	No	No	No	No	No	No	No	OK	No	No		-
ESC GS ) SP (fn = 50)	No	No	No	No	No	No	No	OK	No	No		-

## • Star Configuration commands

Commands	Model Name											StarLine
	mPOP	SM-L200	SM-L300	SM-S,T Series	mC-Print3 (1st Gen.)	mC-Print2	TSP100IV TSP100IV SK	mC-Label3	mC-Print3 (2nd Gen.)	BSC10II		
ESC GS ) # (fn = 48)	No	No	No	No	No	No	No	OK	No	No		-
ESC GS ) # (fn = 49)	No	No	No	No	No	No	No	OK	No	No		-



*URL: <https://www.starmicronics.com/support/>*